

DC Programmable Power Supply

Series IT6800A/B User's Manual

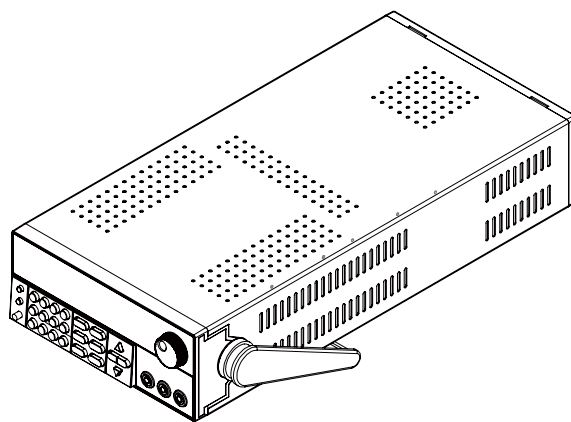

Model: IT6831A/IT6832A/IT6833A/IT6835A/IT6861A
/IT6862A/IT6863A/IT6872A/IT6873A/IT6874A
/IT6832B/IT6833B/IT6835B/IT6861B/IT6862B
/IT6863B/IT6872B /IT6873B/IT6874B

Version: 3.1

Notices

© Itech Electronic, Co., Ltd. 2019

No part of this manual may be reproduced in any form or by any means (including electronic storage and retrieval or translation into a foreign language) without prior permission and written consent from Itech Electronic, Co., Ltd. as governed by international copyright laws.

Manual Part Number

IT6800A/B-402187

Revision

Third Edition: Jan. 21, 2019

Itech Electronic, Co., Ltd.

Trademarks

Pentium is U.S. registered trademarks of Intel Corporation.

Microsoft, Visual Studio, Windows and MS Windows are registered trademarks of Microsoft Corporation in the United States and/or other countries and regions.

Warranty

The materials contained in this document are provided “as is”, and is subject to change, without prior notice, in future editions. Further, to the maximum extent permitted by applicable laws, ITECH disclaims all warranties, either express or implied, with regard to this manual and any information contained herein, including but not limited to the implied warranties of merchantability and fitness for a particular purpose. ITECH shall not be held liable for errors or for incidental or indirect damages in connection with the furnishing, use or application of this document or of any information contained herein. Should ITECH and the user enter into a separate written agreement with warranty terms covering the materials in this document that conflict with these terms, the warranty terms in the separate agreement shall prevail.

Technology Licenses

The hardware and/or software described herein are furnished under a license and may be used or copied only in accordance with the terms of such license.

Restricted Rights Legend

Restricted permissions of the U.S. government. Permissions for software and technical data which are authorized to the U.S. Government only include those for custom provision to end users. ITECH follows FAR 12.211 (technical data), 12.212 (computer software). DFARS 252.227-7015 (technical data--commercial products) for national defense and DFARS 227.7202-3 (permissions for commercial computer software or computer software documents) while providing the customized business licenses of software and technical data.

Safety Notices

CAUTION

A CAUTION sign denotes a hazard. It calls attention to an operating procedure or practice that, if not correctly performed or adhered to, could result in damage to the product or loss of important data. Do not proceed beyond a CAUTION sign until the indicated conditions are fully understood and met.

WARNING

A WARNING sign denotes a hazard. It calls attention to an operating procedure or practice that, if not correctly performed or adhered to, could result in personal injury or death. Do not proceed beyond a WARNING sign until the indicated conditions are fully understood and met.



NOTE

A NOTE sign denotes important hint. It calls attention to tips or supplementary information that is essential for users to refer to.

Quality Certification and Assurance

We certify that series IT6800A/B power supply meets all the published specifications at time of shipment from the factory.

Warranty

ITECH warrants that the product will be free from defects in material and workmanship under normal use for a period of one (1) year from the date of delivery (except those described in the Limitation of Warranty below).

For warranty service or repair, the product must be returned to a service center designated by ITECH.















- The product returned to ITECH for warranty service must be shipped PREPAID. And ITECH will pay for return of the product to customer.
- If the product is returned to ITECH for warranty service from overseas, all the freights, duties and other taxes shall be on the account of customer.

Limitation of Warranty

This Warranty will be rendered invalid in case of the following:

- Damage caused by circuit installed by customer or using customer own products or accessories;
- Modified or repaired by customer without authorization;
- Damage caused by circuit installed by customer or not operating our products under designated environment;
- The product model or serial number is altered, deleted, removed or made illegible by customer;
- Damaged as a result of accidents, including but not limited to lightning, moisture, fire, improper use or negligence.

Safety Symbols

	Direct current		ON (power on)
	Alternating current		OFF (power off)
	Both direct and alternating current		Power-on state
	Protective conductor terminal		Power-off state
	Earth (ground) terminal		Reference terminal
	Caution, risk of electric shock		Positive terminal
	Warning, risk of danger (refer to this manual for specific Warning or Caution information)		Negative terminal
	Frame or chassis terminal	-	-

Safety Precautions

The following safety precautions must be observed during all phases of operation of this instrument. Failure to comply with these precautions or specific warnings elsewhere in this manual will constitute a default under safety standards of design, manufacture and intended use of the instrument. ITECH assumes no liability for the customer's failure to comply with these precautions.

WARNING

- Do not use the instrument if it is damaged. Before operation, check the casing to see whether it cracks. Do not operate the instrument in the presence of inflammable gasses, vapors or dusts.
- The power supply is provided with a three-core power line during delivery and should be connected to a three-core junction box. Before operation, be sure that the instrument is well grounded.
- Make sure to use the power cord supplied by ITECH.
- Check all marks on the instrument before connecting the instrument to power supply.
- Use electric wires of appropriate load. All loading wires should be capable of bearing maximum short-circuit current of power supply without overheating. If there are multiple electronic loads, each pair of the power cord must be capable of bearing the full-loaded rated short-circuit output current
- Ensure the voltage fluctuation of mains supply is less than 10% of the working voltage range in order to reduce risks of fire and electric shock.
- Do not install alternative parts on the instrument or perform any unauthorized modification.
- Do not use the instrument if the detachable cover is removed or loosen.
- To prevent the possibility of accidental injuries, be sure to use the power adapter supplied by the manufacturer only.
- We do not accept responsibility for any direct or indirect financial damage or loss of profit that might occur when using the instrument.
- This instrument is used for industrial purposes, Do not apply this product to IT power supply system.
- Never use the instrument with a life-support system or any other equipment subject to safety requirements.

CAUTION

- Failure to use the instrument as directed by the manufacturer may render its protective features void.
- Always clean the casing with a dry cloth. Do not clean the internals.
- Make sure the vent hole is always unblocked.

Environmental Conditions

The instrument is designed for indoor use and an area with low condensation. The table below shows the general environmental requirements for the instrument.



Environmental Conditions	Requirements
Operating temperature	0°C to 40°C
Operating humidity	20%-80% (non-condensation)
Storage temperature	-20°C to 70 °C
Altitude	Operating up to 2,000 meters
Pollution degree	Pollution degree 2
Installation category	II



Note

To make accurate measurements, allow the instrument to warm up for 30 min before operation.

Regulatory Markings

	<p>The CE mark indicates that the product complies with all the relevant European legal directives. The specific year (if any) affixed refers to the year when the design was approved.</p>
	<p>The instrument complies with the WEEE Directive (2002/96/EC) marking requirement. This affixed product label indicates that you must not discard the electrical/electronic product in domestic household waste.</p>
	<p>This symbol indicates the time period during which no hazardous or toxic substances are expected to leak or deteriorate during normal use. The expected service life of the product is 10 years. The product can be used safely during the 10-year Environment Friendly Use Period (EFUP). Upon expiration of the EFUP, the product must be immediately recycled.</p>

Waste Electrical and Electronic Equipment (WEEE) Directive



2002/96/EC Waste Electrical and Electronic Equipment (WEEE) Directive

This product complies with the WEEE Directive (2002/96/EC) marking requirement. This affix product label indicates that you must not discard the electrical/electronic product in domestic household waste.

Product Category

With reference to the equipment classifications described in the Annex I of the WEEE Directive, this instrument is classified as a

“Monitoring and Control Instrument”.
To return this unwanted instrument, contact your nearest
ITECH office.

Compliance Information

Complies with the essential requirements of the following applicable European Directives, and carries the CE marking accordingly:

- Electromagnetic Compatibility (EMC) Directive 2014/30/EU
- Low-Voltage Directive (Safety) 2014/35/EU

Conforms with the following product standards:

EMC Standard

IEC 61326-1:2012/ EN 61326-1:2013 ¹²³

Reference Standards

CISPR 11:2009+A1:2010/ EN 55011:2009+A1:2010 (Group 1, Class A)

IEC 61000-4-2:2008/ EN 61000-4-2:2009

IEC 61000-4-3:2006+A1:2007+A2:2010/ EN 61000-4-3:2006+A1:2008+A2:2010

IEC 61000-4-4:2004+A1:2010/ EN 61000-4-4:2004+A1:2010

IEC 61000-4-5:2005/ EN 61000-4-5:2006

IEC 61000-4-6:2008/ EN 61000-4-6:2009

IEC 61000-4-11:2004/ EN 61000-4-11:2004

1. The product is intended for use in non-residential/non-domestic environments. Use of the product in residential/domestic environments may cause electromagnetic interference.
2. Connection of the instrument to a test object may produce radiations beyond the specified limit.
3. Use high-performance shielded interface cable to ensure conformity with the EMC standards listed above.

Safety Standard

IEC 61010-1:2010/ EN 61010-1:2010

Content

DC Programmable Power Supply	1
Quality Certification and Assurance	1
Warranty	1
Limitation of Warranty.....	1
Safety Symbols.....	1
Safety Precautions	2
Environmental Conditions.....	3
Regulatory Markings.....	3
Waste Electrical and Electronic Equipment (WEEE) Directive.....	3
Compliance Information.....	5
Chapter1 Inspection and Installation	1
1.1 Verifying the Shipment.....	1
1.2 Instrument Size Introduction.....	1
1.3 Adjustment of Handle	2
1.4 Disassembly of Handle.....	4
1.5 Rack Mounting.....	5
1.6 Connecting the Power Cord	5
Chapter2 Quick Start	6
2.1 Brief Introduction	6
2.2 Front Panel Introduction	7
2.3 Keypad introduction.....	7
2.4 VFD Description	8
2.5 Rear Panel Introduction.....	9
2.6 Power-on Selftest	10
2.7 Output Verification	12
Chapter3 Functions and Characteristics	14
3.1 Local Mode/Remote Mode	14
3.2 Dual-range switch(IT6860A/B/IT6870A/B)	14
3.3 Voltage setting	14
3.4 Current setting.....	15
3.5 Output on/off.....	15
3.6 switch the actual/setting value display	15
3.7 CC/CV mode	15
3.8 Save/Recall	16
3.9 Trigger operation	16
3.10 Menu Operation.....	16
3.11 OVP Function.....	24
3.12 KEY LOCK.....	24
3.13 Remote Sense Function	24
Chapter4 Remote Operation	26
4.1 RS232 interface	26
4.2 USB interface	27
4.3 GPIB interface (Only for IT6800B series).....	28
Chapter5 Specifications	29
5.1 Specifications	29
5.2 Supplementary Characteristics	40
Appendix	41
Specifications of Red and Black Test Lines.....	41
No output	41
How to avoid it couldn't start when test battery	41

Chapter1 Inspection and Installation

1.1 Verifying the Shipment

Unpack the box and check the contents before operating the instrument. If wrong items have been delivered, if items are missing, or if there is a defect with the appearance of the items, contact the dealer from which you purchased the instrument immediately. The package contents include:

Checklist of Package Contents

Item	Qty.	Model	Remarks
Power Supply	x1	IT6800A/B Series	The IT6800A/B series include: IT6831A/IT6832A/IT6833A/IT6835A/IT6861A/IT6862A/IT6863A/IT6872A/IT6873A/IT6874A/IT6832B/IT6833B/IT6835B/IT6861B/IT6862B/IT6863B/IT6872B/IT6873B/IT6874B
Power cord	x1	IT-E171/IT-E172 /IT-E173/IT-E174	User may select an appropriate power cord that matches the specifications of power socket used in the area. See the Section Connecting the Power Cord for details.
Ex-factory Test Report	x1	-	It is the test report of the instrument before delivery.



NOTE

Upon verification of the shipment, keep the package and relevant contents thereof in a safe place. When returning the instrument for warranty service or repair, the specified packing requirements shall be met.

1.2 Instrument Size Introduction

The instrument should be installed at well-ventilated and rational-sized space. Please select appropriate space for installation based on the power supply size.

IT6800A/B series power supply different models are the same size, the detail size of the power supply are shown as below. (Take the example of IT6862A)

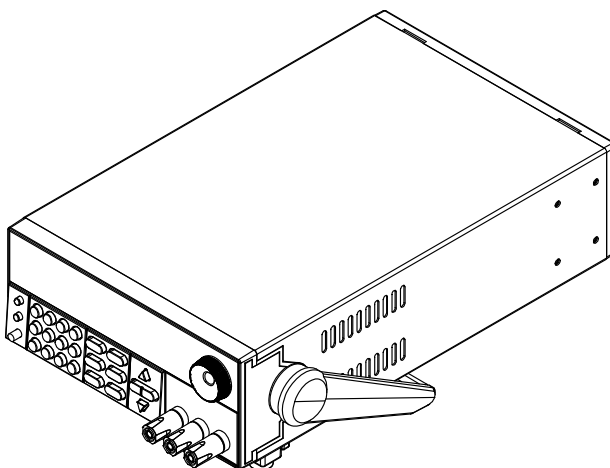

Dimension:

Width: 255.3mm

Height: 108.7mm

Depth: 374.4mm

Detailed Dimension Drawing

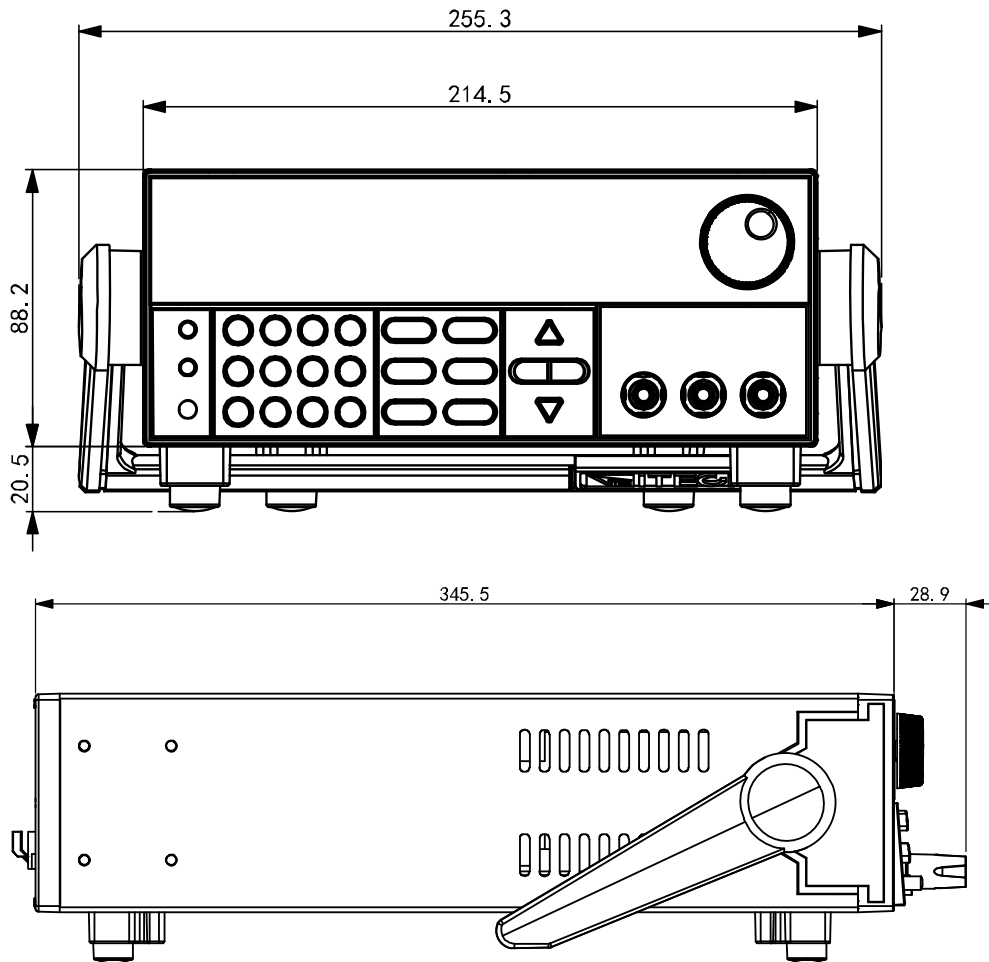

1.3 Adjustment of Handle

IT6800A/B series power supply are equipped with a handle for user to easily carry and place it.

The power supply handle may be adjusted based on three methods (as shown in icons below). Be sure that appropriate force is applied to adjust the power supply handle to appropriate position. (Take the example of IT6862A)

Horizontal placement

Place the instrument on the desk horizontally.

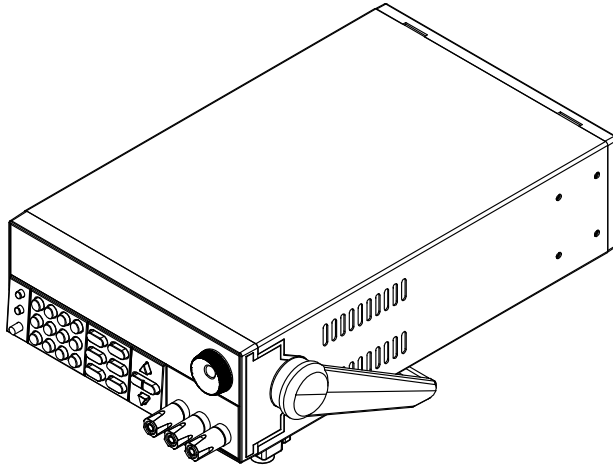

Adjustment

Adjust the power supply handle to the state of rotation.

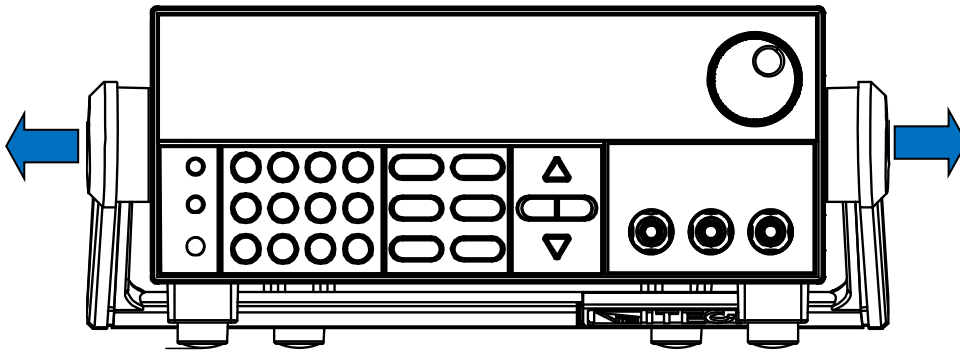

Adjust the power supply handle to appropriate position.

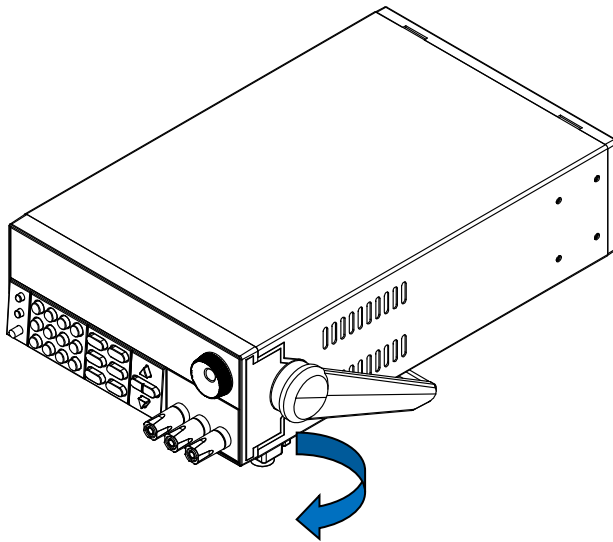

Place the instrument on the desk.

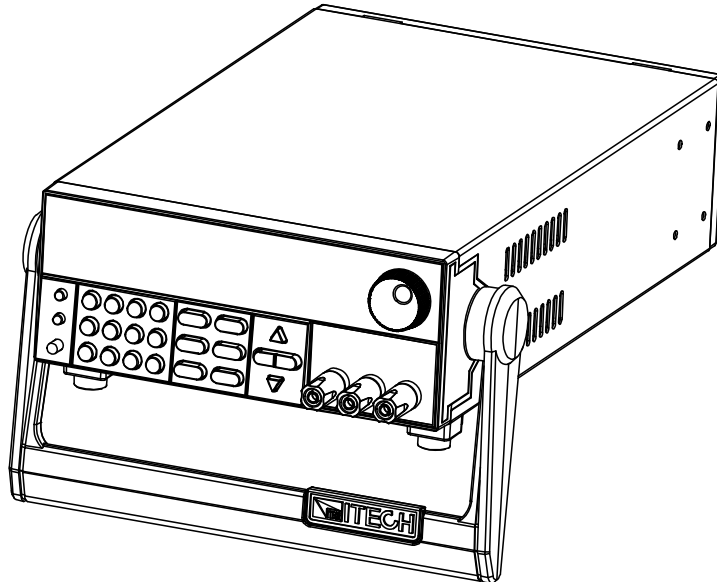

1.4 Disassembly of Handle

Please disassemble the handle before installing equipment on the support.

Disassembly steps (take the example of IT6862A):

1. Align the locking mouth, and pull out the handle towards two sides.

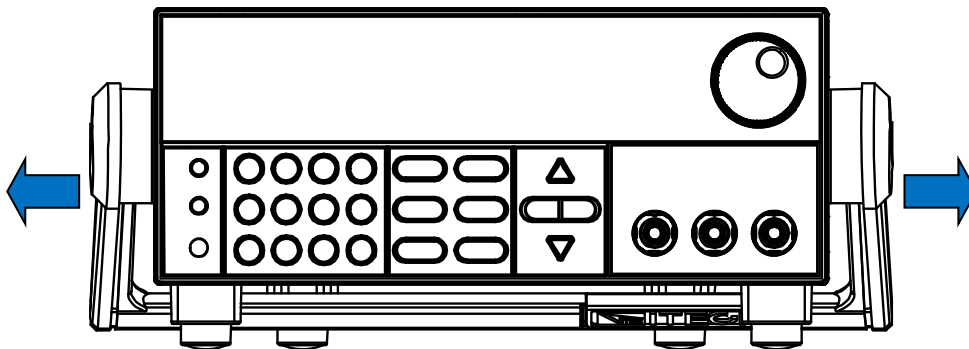

2. Rotate the handle to the appropriate position.

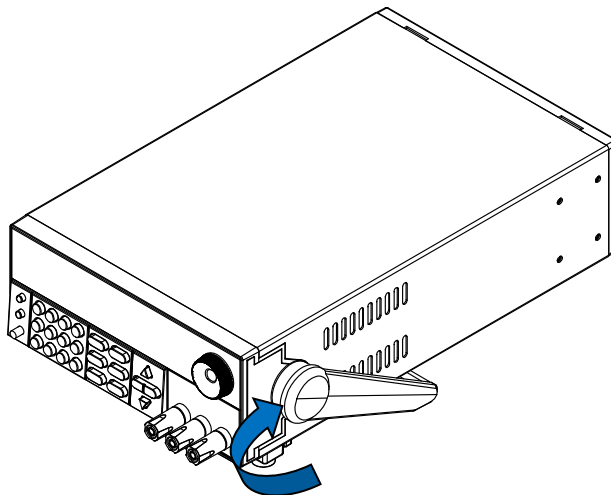

NOTE

Do not use too much force and mind your hands during disassembly of power supply handle

3. Adjust the handle to the position as shown as below.

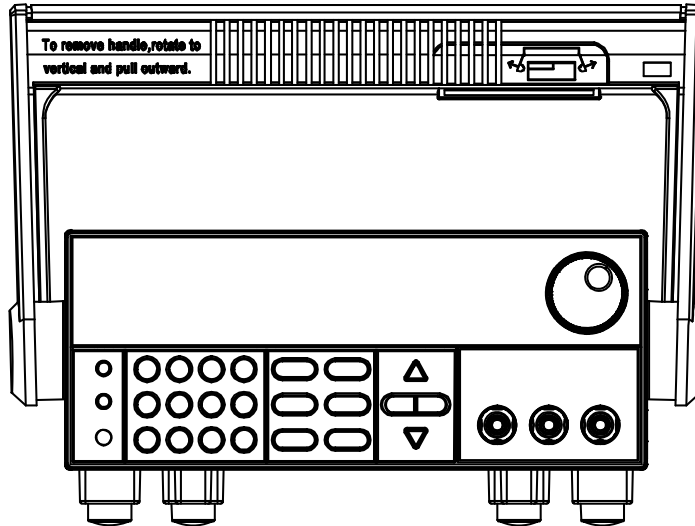
NOTE

To easily disassemble handle, align the locking mouth and locking device, which is between the handle and the instrument

1.5 Rack Mounting

This instrument can be installed on standard 19-inch rack. ITECH provides user with IT-E151/IT-E151A rack, as an optional mount kit. The detailed operation please refer to the User Manual of your mount kit.

1.6 Connecting the Power Cord

Connect the power cord after checking that the power switch of the instrument is turned OFF. Only use the power cord supplied as a standard accessory.

Select from the following Schedule of Power Cord Specifications an appropriate power cord that matches the voltage for the area in which you use the instrument. If the power cord included in the instrument you purchased does not match the voltage, contact the dealer or manufacturer for change.

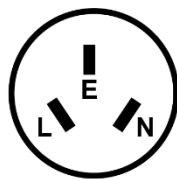

China
IT-E171



United States &
Canada
IT-E172

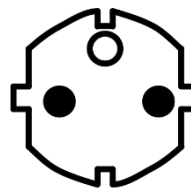

Europe
IT-E173



England
IT-E174

There are two kinds of working voltage for the power supply: 110V and 220V, so please pay attention to the working input voltage.

AC input levels (select by change the AC power switch on the bottom of the power supply)

Option Opt.01: 220VAC \pm 10%, 47 to 63 Hz

Option Opt.02: 110 VAC \pm 10%, 47 to 63 Hz

Chapter2 Quick Start

This chapter introduces the front panel, the rear panel, key functions and VFD display function of the power supply, make sure that you can quickly know the appearance, instruction and the key function before you operate the load, Help you make better use of this series of power supply.

2.1 Brief Introduction

IT6800A/B series power supply is single output DC programmable power supply, which support panel programming and offer OCP and OVP. Furthermore, built-in RS232/USB communication interface is suitable for either bench or rack mounted operation, which can provide multiple solutions according to the requirements of your design and test. IT6860A/B series and IT6870A/B series programming DC power supply offer the dual-range voltage switch for your choice, which can replace two ordinary ones.

- High-visibility vacuum fluorescent display (VFD)
- Digital keypad operation
- High accuracy and high resolution
- Low ripple and low noise
- Intelligent fan control, energy conservation, noise reduction
- Can be monitored by computer software
- Output voltage and current values accordance with procedure
- Can use the knob to adjust the voltage and current
- Can adjust the numbers steps using the cursor
- Can set the output timer(0.1~9999.9S)
- Standard RS232/USB communication interface
- Rich SCPI orders and IT6820 compatible frame protocol to facilitate the formation of intelligent test platform

Model	Voltage	Current	Power
IT6831A	0~18V	0~10A	0~180W
IT6832A	0~32V	0~6A	0~192W
IT6833A	0~72V	0~3A	0~216W
IT6835A	0~50V	0~4A	0~200W
IT6861A	0~20V/ 0~8V	0~5A/ 0~9A	0~100W/ 0~72W
IT6862A	0~32V/ 0~12V	0~3A/ 0~6A	0~96W/ 0~72W
IT6863A	0~72V/ 0~32V	0~1.5A/ 0~3A	0~108W/ 0~96W
IT6872A	0~35V/0~15V	0~4A/0~7A	0~140W/0~105W
IT6873A	0~75V/ 0~32V	0~2A/ 0~4A	0~150W/ 0~128W
IT6874A	0~150V/ 0~60V	0~1.2A/ 0~2A	0~180W/ 0~120W
IT6832B	0~32V	0~6A	0~192W
IT6833B	0~32V	0~6A	0~192W
IT6835B	0~50V	0~4A	0~200W
IT6861B	0~20V/ 0~8V	0~5A/ 0~9A	0~100W/ 0~72W
IT6862B	0~32V/ 0~12V	0~3A/ 0~6A	0~96W/ 0~72W
IT6863B	0~72V/ 0~32V	0~1.5A/ 0~3A	0~108W/ 0~96W
IT6872B	0~35V/ 0~15V	0~4A/ 0~7A	0~140W/ 0~105W
IT6873B	0~75V/ 0~32V	0~2A/ 0~4A	0~150W/ 0~128W
IT6874B	0~150V/ 0~60V	0~1.2A/ 0~2A	0~180W/ 0~120W

2.2 Front Panel Introduction

IT6800A/B series power supplies have two kinds of front panels. The output terminals of IT6830A/B series power supply are circular sockets, while IT6860A/B series power supplies are wiring terminals. Take the example of IT6860A.

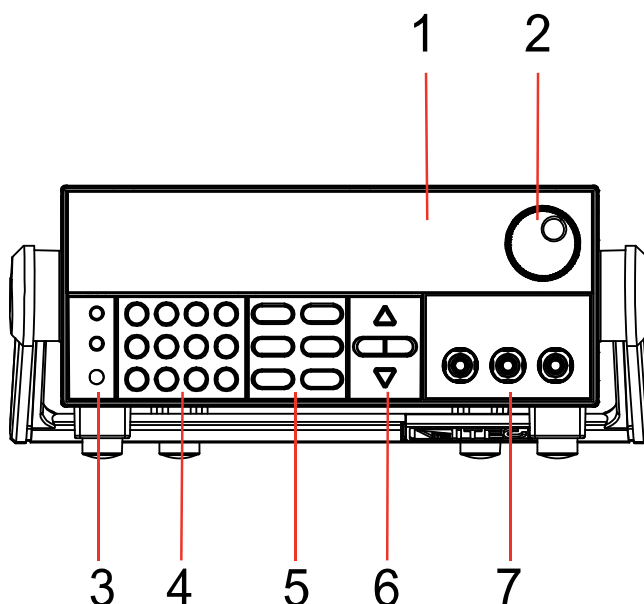

- ①VFD display
- ②Rotary knob
- ③Compound key, the local switch key and power switch
- ④Number keys and ESC escape key
- ⑤Function keys
- ⑥UP、DOWN, LEFT and RIGHT key, to move cursor
- ⑦Output terminals

2.3 Keypad introduction

The key functions and keys of IT6830A/B series power supply are shown as below picture.

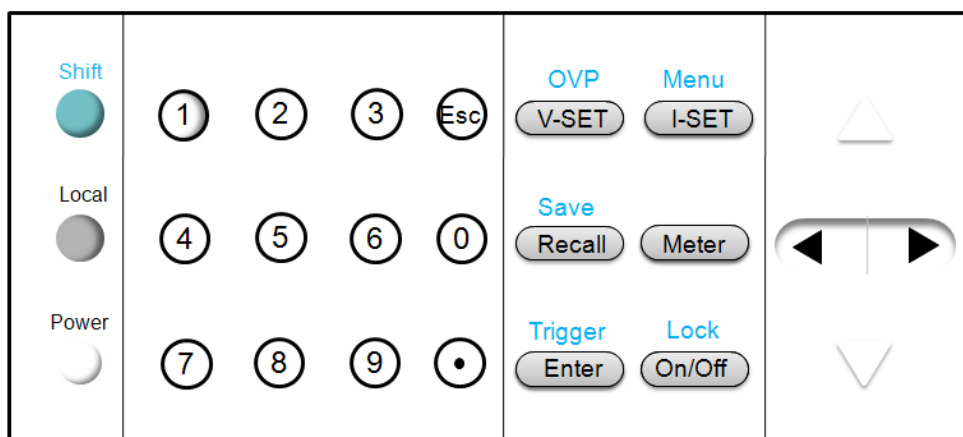

The key functions and keys of IT6870A/B series power supply are shown as

below picture.

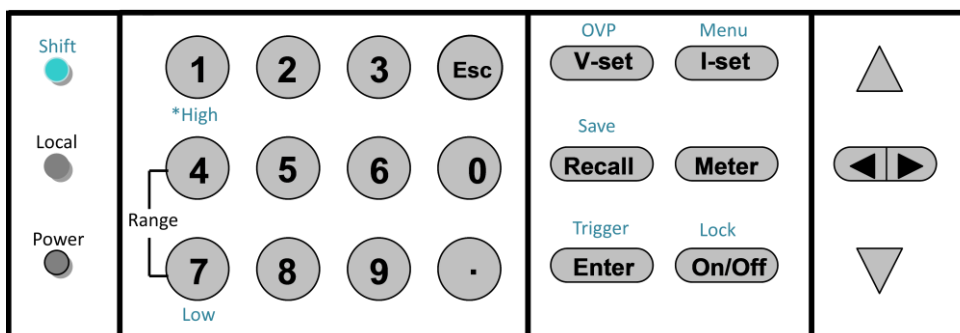

Keys	Name and the function
Shift	Compound key, co-work with OVP、Menu、Save、Trigger、Lock、and numeric key 4 and 7 to switch the dual-range
Local	Local switch key, switch from remote mode to local operation mode
Power	Power on key
0-9	Numeric keys
OVP	Voltage set key, set the output voltage/over voltage protection point for the power supply
Menu	Current set key, set the output current/menu function key, to set the relevant Parameters for the power supply
Save	Callback key to call up a set value of system parameters already stored / storage key, to save system parameter settings
	Meter key, to switch from value set panel and the actual output value display
Trigger	Enter key, to confirm the number entered and operation / trigger button, which is used to trigger the List test.
Lock	Output on (off) keys, control power output state / keypad lock function keys, used to lock the panel buttons
	Left and right movement keys, used to set the value, to adjust the cursor to the specified location
	Up and down keys, used to select an item in the menu or increase (decrease) the output voltage or current values
	Escape key

2.4 VFD Description

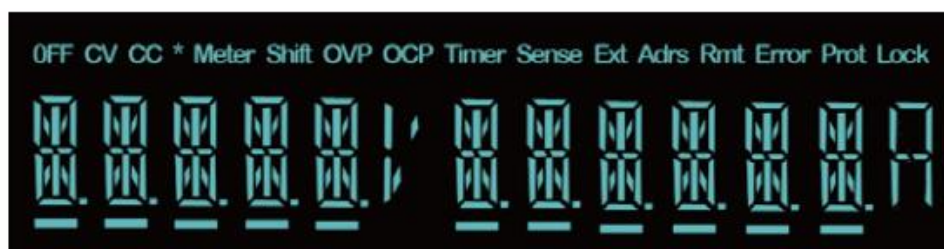

char	Function	char	Function
OFF	Output is off	Timer	Output on timer function is enabled

CV	The power supply is in constant voltage mode	Sense	Not in use
CC	The power supply is in constant current mode	Ext	Not in use
*	The power supply is in high voltage range	Adrs	(USB) light when the address match or (RS232) received order
Meter	“Meter” key is pressed	Rmt	The power supply is in remote mode
Shift	Shift key is pressed, use compound keys	Error	The power supply has error or fault
OVP	OVP function is enabled	Prot	The power supply is in OVP /OTP protection
OCP	Not in use	Lock	Keypad is locked

2.5 Rear Panel Introduction

The rear panels of IT6800A/B series power supply are divided into series-A and series-B.

The rear panels and keyboards of IT6800A series power supply are shown as below.

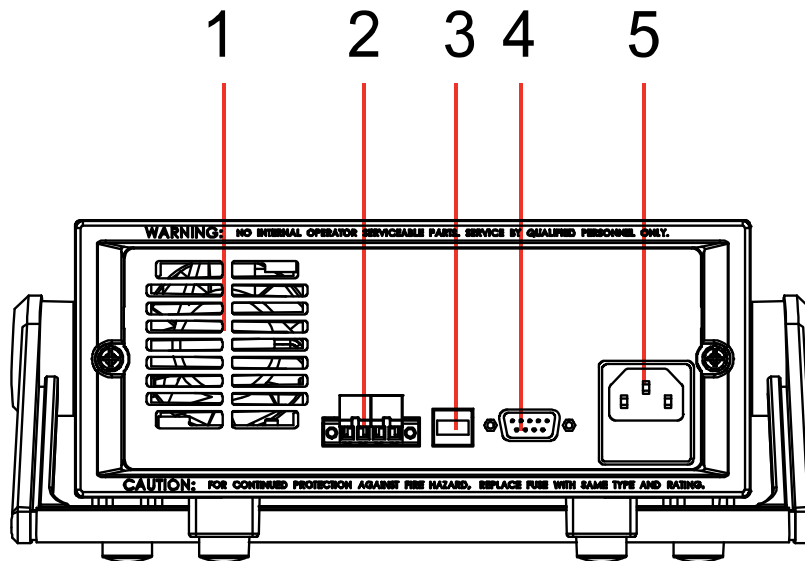

- ① Cooling window
- ② Remote sense terminal
- ③ USB communication interface
- ④ RS232 communication interface
- ⑤ AC power socket (fuse contained)

The rear panels and keyboards of IT6800B series power supply are shown as below.

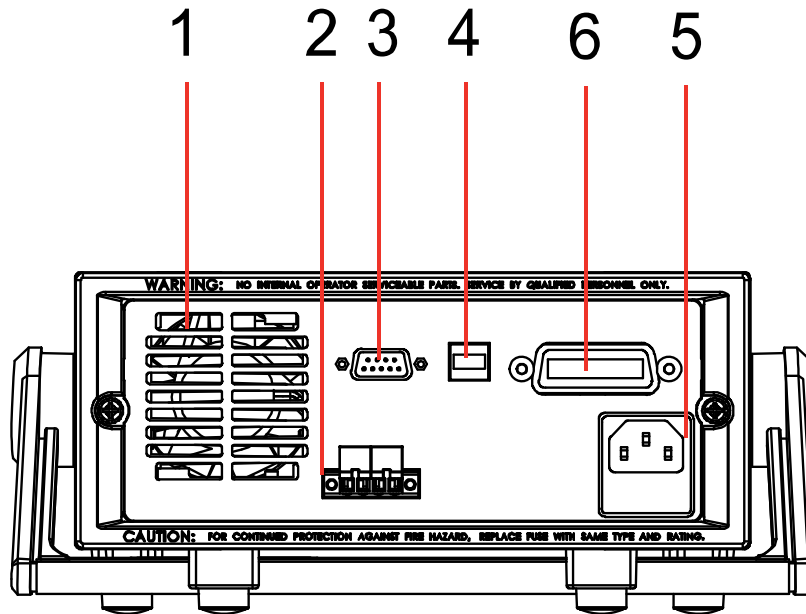

- ① Cooling window
- ② Remote sense terminal
- ③ RS232 communication interface
- ④ USB communication interface
- ⑤ AC power socket (fuse contained)
- ⑥ GPIB communication interface

2.6 Power-on Selftest

A successful test process indicates that the instrument meets the factory specifications and can be operated well.

Before operation, please confirm that you have fully understood the safety instructions.

WARNING

- The AC input voltage is 110V or 220V, please check the switching at the bottom of the power supply, to make sure it matches the voltage in your city. Otherwise, the power supply may be damaged.
- Use the wires of rating value and all load lines shall be capable of withstanding the maximum short circuit output current of the power supply without causing overheat. If there are more than one load, each pair of load lines shall be capable of withstanding the full rated short-circuit output current of the power supply.
- Be sure to connect the main power socket to the power outlet of protective grounding. Do not use terminal board without protective grounding. Before operation, be sure that the power supply is well grounded.
- To avoid burning out, pay attention to marks of positive and negative polarities before wiring.

Self-test steps

Normal self-test procedures:

1. Correctly connect the power cord. Press **[Power]** key to start up. VFD display information is as below.

INIT....
SCAN SYSTEM

- After the power selftest, VFD displays the state of voltage and current as below.

OFF
0.000V 0.0000A

Error Information References

The following error information may occur when an error occurs during Power On self-test:

- About 1second after power on, if the EEPROM was damaged, the VFD will display (about 1 S):

EEPROM FAIL

- If the last power status in EEPROM is lost, then VFD will display information (about 1 S) as below:

SYST LOST

- If the calibration data in EEPROM is lost, then VFD will display (about 1S) as below:

CAL LOST

- If the factory calibration data in EEPROM is lost, and then the VFD will display(about 1 S) as below:

FACT LOST

Exception handling

If the power supply cannot start normally, please check and take measures by reference to steps below.

- Check whether the power line is correctly connected and confirm whether the power supply is powered.
Correct wiring of power line => 2
Incorrect wiring of power line => Re-connect the power line and check whether the exception is removed.
- Check whether the power in On. [**Power**] key is under “  ” On status.
Yes => 3
No => Please check the [**Power**] key to start power and check whether the exception is removed.
- Check whether set power voltage of instrument is larger than the power supply voltage. If set power voltage is 220 V and the supply voltage is 110V, the power supply cannot start.
- Check whether the fuse of electronic fuse is burned out.
If yes, change fuse. Detailed steps:
 - Pull out power line and take out the fuse box at power line jack with a small screw driver. As shown below.

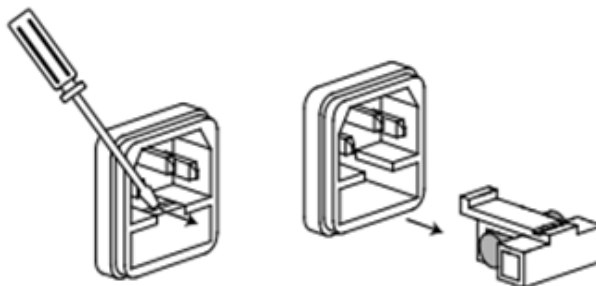

- 2) If the fuse is fused, please change fuse of same specification based on machine model. See the table blow for matching information of fuse and machine model.

Model	Fuse specification (110VAC)		Fuse specification (220VAC)	
IT6831A	6.3A		3.15A	
IT6832A				
IT6833A				
IT6835A	6.3A		3.15A	
IT6860A	T5A 250V		T2.5A 250V	
IT6862A				
IT6863A				
IT6872A	6.3A 250V		3.15A 250V	
IT6873A				
IT6874A				
IT6832B	6.3A		3.15A	
IT6833B				
IT6835B				
IT6861B	T5A 250V		T2.5A 250V	
IT6862B				
IT6863B				
IT6872B	6.3A		3.15A	
IT6873B	6.3A		3.15A	
IT6874B	6.3A		3.15A	

- 3) After replacement, install the fuse box back to original position, as shown below.

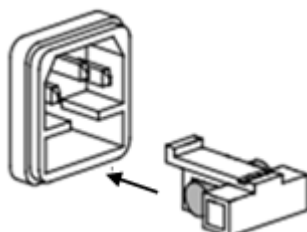

2.7 Output Verification

Output verification verify that the power supply outputs the correct voltage and current levels and properly responds to entries from the front panel.

Voltage Output Check

The following steps verify basic voltage functions without load.

1. Turn on the power supply

2. Set the current value ($\geq 0.01A$).
3. Enable the outputs
Press **On/Off** to let the ON annunciator and the CV annunciator turn on to light.
4. Turn on Meter mode
Press **Meter** to light the button, the Meter status Mark light on the display is turned on.
5. Set the voltage level.
Set different voltage values, check the voltage value displayed on the VFD is close to the voltage value you set.
6. Ensure that the voltage can be adjusted from zero to the full rated value

Current Output check

The following steps check basic current functions with a short across the power supply's output.

1. Turn on the power supply
2. Enable the output
Press **On/Off** key to ensure that the output is disabled. At the same time, the OFF status mark is on the VFD.
3. Connect a short across (+) and (-) output terminals with an insulated test lead, use a wire sufficient to handle the maximum current.
4. Adjust the voltage value to 1V.
5. Turn on the power output.
Press **On/Off** key to ensure the output is enabled, at the same time there is CC status sign on the VFD.
6. Turn on Meter mode
Press **Meter** to light the button, the Meter status Mark light on the display is turned on.
7. Adjust the current value
Set some different current values, check whether the voltage value on VFD is near 0v, and the current on it is close to the value you set.
8. Make sure that the current can be adjusted from 0 to full rated value.
9. Turn off the output of the power supply, and remove the short wire.

Chapter3 Functions and Characteristics

This chapter elaborates on the functions and characteristics of power supplies. Contents following sections:

- local/remote
- Voltage setting
- Current setting
- Output on/off
- Switching the setting value and actual value
- Dual-range switch(IT6860A/B/IT6870A/B)
- Adjust voltage/current/power
- Save operation
- Trigger operation
- Menu operation
- OVP function
- Keyboard lock function



3.1 Local Mode/Remote Mode

 (Local) button on the front panel is used to switch remote mode to local mode.

After power on the power supply, it defaults in local mode. In this mode, all buttons are enabled. While in remote control mode, all buttons are forbidden except local button. Local and remote control mode can be switched by PC. It will not change the output parameters when mode is changed.

3.2 Dual-range switch(IT6860A/B/IT6870A/B)

Operation: Press  (shift) +number 4 or 7

Take IT6874A as an example, press  (Shift)+number 4,VFD will appear a mark “*”,it represents in high voltage level(0-150V,1.2A).Press  (shift)+number 7,mark “*” will disappear which indicates in low voltage level now(0-60V,2A).

In high voltage level, setting voltage is higher than the max voltage in low voltage level. At this moment, if customer switch to lower voltage level. Then the voltage will default to be limited at the max voltage value of low voltage level. In low voltage level, working current is higher than in high voltage level. So, when customer switch to high voltage level (with lower current range), the current will default to be limited at the max current value of high voltage level.





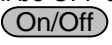

NOTE

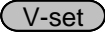

The output of the power supply will be OFF after switching the voltage level. You need to wait for one second before pressing the  button to turn on the output. The button will be no response in the one second. If you send the 'OUTP ON' command, the system will return the error message 'Output Locked'.

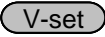

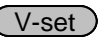

3.3 Voltage setting

IT6800A/B series power supply enables customer to set voltage from 0V to

rated value. Press  button, it will be lit. Now, there are three ways to set the voltage:

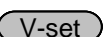



Solution1: press  button-----press  button to adjust the cursor's position-----press  and  button to increase or decrease the setting value.

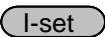

Solution2: press  button-----press  button to adjust the cursor's position-----adjust the knob to increase or decrease the setting value.

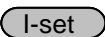

Solution3: press  button+ number  to  to set the voltage value. Then press  button to confirm.

3.4 Current setting

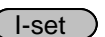
IT6800A/B series power supply enables customer to set current from 0V to rated value. Press  button, it will be lit. Now, there are three ways to set the voltage:

Solution1: press  button-----press  button to adjust the cursor's position-----press  and  button to increase or decrease the setting value.

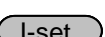
Solution2: press  button-----press  button to adjust the cursor's position-----adjust the knob to increase or decrease the setting value.

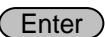
Solution3: press  button+ number  to  to set the voltage value. Then press  button to confirm.

3.5 Output on/off

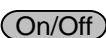
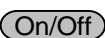
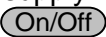
 button is used to control the output of power supply. When  button is lit, it represents output has been turned on. If  button is dark, it indicates that output is off. In output on mode, the indicator light CV or CC will be lit.

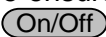
Note: Please ensure the power supply and DUT has been connected well and then press  button to turn on the output.

3.6 switch the actual/setting value display

 button is used to switch the display between actual and setting value.

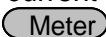

When  button is lit, it shows actual voltage and current on front panel. Meanwhile, VFD will appear a marker of "meter". When  button is dark, it shows setting voltage and current on front panel.

3.7 CC/CV mode

According the ohm's law, output current is determined by output voltage and the resistance of load. When actual current is less than the setting value, power supply will function in CV mode. And CV status indicator lamp will be lit.

If actual current is above the setting value or rated value, power supply will change to CC mode, and CC status indicator lamp will be lit.

3.8 Save/Recall

IT6800A/B series power supply enables customer to store up to 9*8 groups of different operating parameters in a non-volatile memory. You can save or recall parameters by  (Shift) +  (Save) buttons directly from the front panel or through command *SAV,*RCL.

Each operating parameters includes a constant voltage value, constant current value and OVP setting value.

Save operation:

Set the desired Voltage and Current value

Press the  (Shift) +  +number 1 to 9 to assign a memory location.

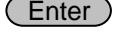
Press  to confirm.

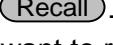

Recall operation:

Keep group setting unchanged, press  +number 1 to 9 to select the memory location where the settings you want to recall are stored.

Group Concept:

When storage amount exceeds 9, you have to enter into menu and select MEM item to change the group set. Meanwhile, to recall a pre-stored parameter should be coordinated with correct group set. For example, if you want to recall parameters which are stored in memory location from 10 to 19, then MEM should be set to group 1.

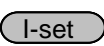
To change group set:

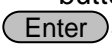
Press  (Shift) +  button to enter the menu, press  button to select SYST SET, press  to confirm.



Press  to select MEM, enter a numerical value, press  to confirm.

3.9 Trigger operation

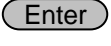
IT6800A/B series power supply supports two different trigger modes Manual and Bus. Configure one of the trigger sources before performing trigger operation.

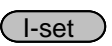

This operation is often used with list operation. It provides a trigger signal to start running a list file. During the process of running a list file, trigger button  (Trigger) will keep blinking until finished.

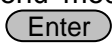
3.10 Menu Operation

Press  (Shift) +  (Menu) to enter menu mode. Use the ,  or knob to scroll through the menu list and press  to select a item and view the parameters. Press Esc button to return to the higher level menu and to quit the menu setting.

IT6800A series



MAX VOLT	Set the Maximum Voltage		
SYST	P-MEM (RESET)	Reset	Return to the factory default setup value
		Keep	“Remembers” and restores the operating

SET			parameters of power supply (voltage, current settings...) before power was turned off. The next time you power up the unit, the parameters will be recalled automatically.			
	P-OUT (OFF)	OFF	Set the Power to OFF state after power up.			
		Keep	"Remembers" and restores the power ON/OFF state of power supply before power was turned off. The next time you power up the unit, the on/off state will be recalled automatically.			
	COMM	RS232	BAUD	Baudrate set		
				4800		
				9600		
				19200		
				38400		
				57600		
				115.2K		
			NONE 8BIT	NONE 8BIT	8BIT None parity	
				EVEN 8BIT	8BIT Even parity	
				ODD 8BIT	8BIT Odd parity	
		USB				
	CMD	SCPI	Set to SCPI protocol			
			SIG	Single unit to communicate with PC		
			MUX	Multiple units to communicate with PC		
		ADDR		Address range is 0-30		
			FRAME	Set to frame protocol		
			ADDR	Address range is 0-30		
	BEEP (ON)	OFF	Disable key sound			
		ON	Enable key sound			
	KNOB (ON)	LOCK	Lock the rotary knob			
		ON	Unlock the rotary knob			
	TRIG (MANUAL)	MANU	Press  (Shift)+  (Trigger) to generate a trigger pulse.			
		BUS	Remote command trigger mode			
	MEM (GROUP1)	GRP1-8	Group set, used with Save/Recall operation			
	TIMER SET	OFF	Disable timer function			
		ON	Enable timer function(0.1-9999.9S)			
	RESET	NO	Remain unchanged of previous menu setup			
		YES	Return to factory default setup			
	EXIT	Quit system menu				

LIST SET	LIST STATE	OFF	Disable list function		
		ON	Enable list function		
	LIST LOAD	Recall list operation file (FILE0-FILE3)			
	LIST EDIT	TIME (SEC)	SEC	Select second as time unit	
			MIN	Select minute as time unit	
		VSET	Set step voltage		
		ISET	Set step current		
		SEC	Set step delay time (0.1-9999.9)		
		NEXT (YES)	YES	Continue to edit the next step	
			NO	finish list file edit	
		REPET	1-65535	Set repeat count	
		SAVE	NO	Do not save the current list file. In this mode, the file can only run for one time. Once you quit the list mode or turn off the unit, the file cannot be recalled.	
	FILE0-FILE3		save list file to assigned memory location		
EXIT	Quit list menu				
POWER INFO	MODEL	Model information			
	VER	Firmware version			
	SN-1	First six number of SN			
	SN-2	Middle six number of SN			
	SN-3	Last six number of SN			
	EXIT	Quit information menu			
EXIT MENU	Quit menu				

IT6800B series

MAX VOLT	Set the Maximum Voltage		
OCP SET	OFF	Disable OCP function.	
	ON	Enable OCP function ON(0~7.0000A)	
SYST SET	P-MEN (RESET)	Reset	Return to the factory default setup value
		Keep	“Remembers” and restores the operating parameters of power supply (voltage, current settings...) before power was turned off. The next time you power up the unit, the parameters will be recalled automatically.
	P-OUT (OFF)	OFF	Set the Power to OFF state after power up.
		Keep	“Remembers” and restores the power ON/OFF state of power supply before power was turned off. The next time you power up the unit, the on/off state will be

			recalled automatically.	
COMM	GPIB	ADDR	Use GPIB interface	
		RS232	BAUD	Baudrate set
	4800			
	9600			
	19200			
	38400			
	57600			
	11.52K			
	NONE 8BIT	NONE 8BIT	8BIT None parity	
		EVEN	8BIT Even parity	
		ODD	8BIT Odd parity	
	USB		Use USB interface	
	BEEP (ON)	OFF	Disable key sound	
ON		Enable key sound		
KNOB (ON)	LOCK	Lock the rotary knob		
	ON	Unlock the rotary knob		
TRIG (MANUAL)	MANU	Press  (Shift) +  (Trigger) to generate a trigger pulse.		
	BUS	Remote command trigger mode		
MEM (GROUP1)	GRP1-8	Group set, used with Save/Recall operation		
TIMER SET	OFF	Disable timer function		
	ON	Enable timer function(0.1-9999.9S)		
RESET	NO	Remain unchanged of previous menu setup		
	YES	Return to factory default setup		
EXIT		Quit system menu		
LIST SET	LIST STATE	OFF	Disable list function	
		ON	Enable list function	
	LIST LOAD		Recall list operation file (FILE0-FILE9)	
	LIST EDIT	TIME (SEC)	SEC	Select second as time unit
			MIN	Select minute as time unit
		VSET		Set step voltage
		ISET		Set step current
		SEC		Set step delay time(0.1-9999)
		NEXT (YES)	YES	Continue to edit the next step
			NO	finish list file edit
		REPET	1-65535	Set repeat count
	SAVE	NO	Do not save the current list file. In this mode, the file can only run for one time. Once you quit the list mode or turn off the unit, the file cannot be recalled.	
		FILE0-FILE9	save list file to assigned memory	

			location
	EXIT	Quit list menu	
POWER INFO	MODEL	Model information	
	VER	Firmware version	
	SN-1	First six number of SN	
	SN-2	Middle six number of SN	
	SN-3	Last six number of SN	
	EXIT	Quit information menu	
	EXIT MENU	Quit menu	



 NOTE

Press  button can help to quit Menu setup and any function button operation.

Maximum voltage (>MAX VOLT)

The maximum voltage can be adjusted from 0A to maximum rated voltage of each model.

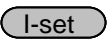
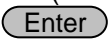
To set max volt:

Press  (Shift) +  (Menu) button to enter menu setup, scroll to >MAX VOLT item and press  to confirm. Using  button to adjust cursor position and set max voltage. Output voltage set will be limited within the range of max voltage.







MAX VOLT default set is the rated voltage of each model.

OCP Function (>OCP) (Only for IT6800B series)

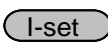
You can set the OCP point. When the circuit current exceeds the set point, the OCP function will be enabled. At the same time, the output of power supply will be OFF and the buzzer will warn. The "prot" remark will be lighted and "OCP" will appear on the VFD.

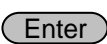
When the setting current is over than the OCP current, the testing instrument will be protected. When the setting current is less than the OCP current, the circuit current will be limited to the setting current for protection.

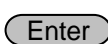
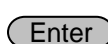
OCP current setting operation:

1. Press  (Shift) +  (Menu) into menu operation.
2. Press  to choose OCP SET, press  to confirm.
3. Press  to select ON, the OCP function will be ON. press  to confirm.
4. Press numeric keys to set OCP current, press  to confirm. Press  to escape menu operation.

Power up setting (>P-MEM)

P-MEM item is used to set operation parameters state of power supply after power up.

If select RESET, means to initialize output parameters to factory default setup.

Every time you power up the unit, the output parameters is always 0V, 0A.

If select KEEP, means to remember last shutdown parameters. The next time you power on the unit, the output parameters are kept as the same with last shutdown setup.

Factory default set is KEEP.

On/Off state after power up (>P-OUT)

P-OUT item is used to set the output state of power supply after power up.

If select KEEP, means to remain the output state of last shutdown. In this selection if you power off the unit in output on state, then the next time you power up the unit, the output is kept in on state.

If select OFF, means every time you power up the unit, it defaults in output OFF state.

Factory default set is OFF.

Communication set (>COMM)

IT6800A/B series power supply has built-in standard RS232/USB communication interface.>COMM item is used to set the communication mode (by RS232 or USB).

It includes six kinds of baudrate set in RS232 communication mode (4800,9600,19200,38400,57600,115.2K).When operating the power supply in remote mode, make sure that you configure identical baud rate settings for the power supply and the computer.

KEY Sound Set (>BEEP)

>BEEP item is used to set the key sound.

If select On, means enable the key sound. If select Off, means disable the key sound.

Factory default set is ON.

KNOB State (>KNOB)

>KONB item is used to set the state of KONB.

If select ON, means unlock the rotary knob. You can use knob to scroll menu or set a value.

If select LOCK, means disable rotary knob function.

Factory default set is ON.

Trigger Mode (>TRIG)

IT6800A/B series power supply supports two different trigger modes (MANU and BUS).

If select MANU, press  (Shift) +  (Trigger) can generate a trigger signal.

If select BUS, then sending command *TRIG can generate a trigger signal.

Factory default set is MANU.



Group set (MEM GROUP)

IT6800A/B series power supply enables customer to store up to 9*8 groups of different operating parameters in a non-volatile memory for quick recall.

How to understand 9*8

9*8: There are 8 groups; each group includes nine different memory locations. The definition of group is as follows:

GRP1: means to Save/Reall parameters in memory location from 1 to 9.

Operation: Press  (Shift) +  (Save) + numeric keys 1to 9( +numeric keys 1 to 9)

GRP2: means to Save/Reall parameters in memory location from 10 to 18.

GRP3-GRP8 is counted on the analogy of the same rule.

Timer setup (>TIMER SET)

TIMER SET item is used to enable or disable timer function.

If select ON, means to enable output Timer. Output will turn off after value set in menu "Timer set" counted down to zero. Meanwhile, VFD will appear a mark of "Timer".

If select OFF, means to disable Timer function.

Factory default set is ON.

Reset to factory setting (>RESET)

RESET is used to return to the factory default setup.

If select YES, means to return to factory default setup.

If select NO, means to keep the current setup unchanged.

Factory default setup is as follows:

P-MEM=KEEP

P-OUT=OFF

COMM=RS232

CMD=SCPI

BEEP= ON

KNOB=ON

TRIG=MANU

MEM=GROUP1

TIMER=OFF



List Function (>List Set)

List mode allows you to create a sequence of steps, store it into the power supply's non volatile memory and execute it. The input parameters for generating a list include the time unit (min or sec), the step voltage, step current, step time and whether continue to the next step, repeat count and whether save the file. Each list file can be edit up to 150 steps.

Once a trigger signal is received, the programmed list will be executed once. Once finished, the instrument will pause until the next trigger signal is received.

Operation:

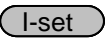
Generate file:five steps:

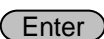
1. Press  (Shift) +  (Menu) into menu operation
2. VFD displays **MAX VOLT**, press  to select **LIST SET**, press 

to confirm

3. VFD displays **LIST STATE**, press **Enter** to confirm. VFD displays **LIST>OFF**, press **▽** to select **>LIST >ON**, press **Enter** to confirm. Then **Enter** button will be lit. You have enables list mode.
4. Press **▽** to select **LIST EDIT**, press **Enter** to confirm.
5. VFD displays **TIME SEC**, press **Enter** to confirm. Continue to next step, or press **▽** to select **>TIME MIN**. Press **Enter** to confirm. Note: no matter you select SEC or MIN, the adjustable range is 0.1~9999.9
6. VFD displays **VSET 0.000**, press numeric keys **0** to **9** or adjust rotary knob to set voltage, press **Enter** to confirm.
7. VFD displays **ISET 0.0000**, press numeric keys **0** to **9** or adjust rotary knob to set current, press **Enter** to confirm.
8. VFD displays **SEC 0.1**, press numeric keys **0** to **9** or adjust rotary knobs to set time press **Enter** to confirm.
9. VFD displays **NEXT >YES**, press **Enter** to confirm.
10. Repeat steps from 5) ~8) for four times. The last time, when VFD shows **NEXT >YES**, press **▽** to select **NEXT >NO**, press **Enter** to confirm.
11. VFD displays **REPET 1**, press numeric keys **0** to **9** or adjust rotary knob to set cycle counts, press **Enter** to confirm. Repeat count range: 1~65535.
12. VFD displays **SAVE >NO**, press **Enter** to confirm. In this condition, the current list file does not be saved. It can only run once. As long as you quit the list mode or turn off the unit, the list file will not exist anymore. You also can press **▽** to select **>SAVE FILE0** to save the file into assigned memory location for quick recall. Press **Enter** to confirm.
13. If you intends not save the list file, VFD will directly display LIST EDIT. If you select to save the list file, VFD will display **LIST EDIT** after blinking contents of SAVE DONE for about three seconds.
14. Press **Esc** two times to exit menu operation.
15. After you edit a list file, set the trigger source in the menu to "**MANUAL**"
16. Press **On/Off** button to turn on the output. Press **●** (Shift) + **Enter** (Trigger) to generate a trigger signal to execute a list file.
17. If you have saved multiple list files. **LIST LOAD** item can help you to recall assigned file that you need. Then press **Esc** two times to escape menu operation. Then the same operation as step 16)
18. Press **●** (Shift) + **I-set** (Menu) into menu setup-----press **▽** to select **LIST SET**, press **Enter** to confirm-----VFD displays **LIST STATE**, press **Enter** to confirm-----press **▽** to select **LIST >OFF**, **Enter** to confirm.

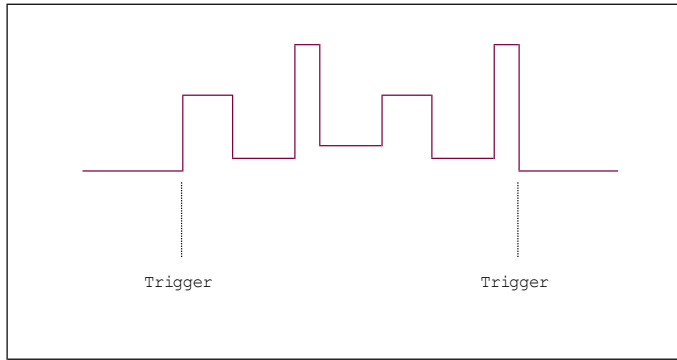

3.11 OVP Function

IT6800A/B series power supply provides OVP function.

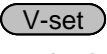
Press  (Shift) +  (OVP) button to set OVP value. After setup, a mark of “ovp” will appear on the VFD which means you have successfully open OVP function.

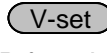
Press  (Shift) +  (OVP) again will release OVP function. Factory default set is off OVP function.

Reasons to trigger OVP:

Customer’s wrong operation, internal circuit error or over high external voltage will cause OVP. Once OVP is triggered, the power supply will off the output immediately. Meanwhile, the VFD displays “OVER VOLT” and there will be a mark of “PROT” appearing on the top right corner of VFD.

The operator should avoid adding an external voltage over 120% of rated voltage across the power supply. Or it will damage the internal components.

When OVP is triggered, you should inspect the external causes and remove it firstly. Then press ON/OFF button to restart the output. If in remote control mode, you should clear the “PROT” state by sending command and then turn on the output.

3.12 KEY LOCK

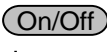
Press  (Shift) +  (Lock) button to lock the function keys. If successfully be locked, a mark of “LOCK” will appear on the front panel. Meanwhile, all the function keys will be disabled except ON/OFF, Meter and Shift buttons.

Press  (Shift) +  (Lock) again can release the key lock function.

3.13 Remote Sense Function

Remote sense is used to maintain good regulation at the load and reduce the degradation of regulation that would occur due to the voltage drop in the leads between the power supply and the load. By connecting the supply for remote voltage sensing, voltage is sensed at the load rather than at the supply’s output terminals. This will allow the supply to automatically compensate for the voltage drop in the load leads and improve regulation.

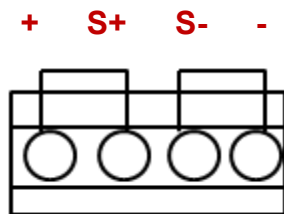

- **S+, S-** : remote sense terminals
- **+, -** : output pins. These pins are identical to the output terminals in the front.

Disable remote sense function:

When you do not use remote sense function, please refer to the below

Using short clip to connect + and S+,- and S-

Connect device under test with output terminals on front of power supply.

Enable remote sense function:

Disconnect + and S+, - and S-

Connect sensing wires from S+ and S- to the load input terminals

Connect output wires from + and – on front panel to the load input terminals

NOTE

To ensure the system stability, please using twisted-pair cables to connect sensing terminals and loads input terminals.

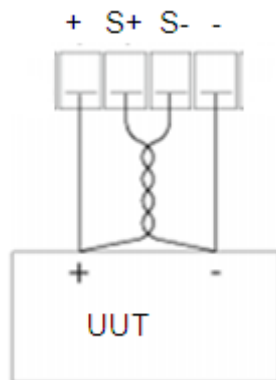

Chapter4 Remote Operation

IT6800A series power supply provides two standard communication interfaces: RS232, USB. IT6800B series power supply provides three standard communication interfaces: RS232, USB, GPIB. User can select anyone to communicate with the computer.

4.1 RS232 interface

There is a COM port (DB9)connector at the rear of the power supply, when connect to computer, you need to connect a cable with COM port on both side;

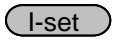
To active connection, you need to press the front panel composite key  (Shift)+  to configurate settings the same as computer configuration settings. RS-232 interface can be used to program all of the SCPI commands.

NOTE

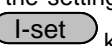
The RS232 settings on the computer side must match the settings in the system menu of the instrument. If any change, please press  (Shift) +  key to enter the system menu and then implement the changes.

RS-232 data format

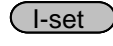
RS-232 data is 10-bit words contain a start bit and a stop bit. The start bit and stop bit can't be edited. However, you can select the parity items by pressing  (Shift) +  key on the front panel and enter the system menu(SYSTEM SET).

Parity options are stored in nonvolatile memory

Baud Rate

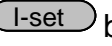
The front panel  (Shift)+  button allows the user to select a baud rate which is stored in the non-volatile memory: 4800/9600/19200 /38400/57600/115200

RS-232 connection

Use a RS232 cable with DB-9 interface, RS-232 serial port can connect with the controller (eg PC). Do not use blank Modem cable. Table 2-2 shows the plug pins.

If your computer is using a RS-232 interface with DB-25 connector, you need an adapter cable with a DB-25 connector at one end and the other side is a DB-9(not blank modem cable)

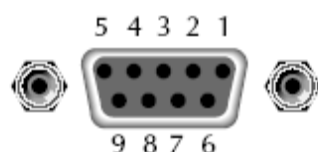

Pin introduction of RS-232 connector

Pin number	Description
1	No connection
2	TXD, transfer data
3	RXD, receive data
4	No connection
5	GND, ground

6	No connection
7	CTS, clear transfer
8	RTS, ready to transfer
9	No connection

RS-232 Troubleshooting:

If there is RS-232 connection problem, check the following:

1. Computer and power supply must configure the same baud rate, parity, data bits and flow control options. Note that the power configuration as a start bit and a stop bit (these values are fixed).
2. As described before in RS-232 connector, you must use the correct interface cable or adapter. Note that even if the cable has the right plug, the internal wiring may be wrong.
3. Interface cable must be connected to the correct serial port on the computer (COM1, COM2, etc.).

Communication Settings

Before communication, you should first make the following parameters on the power supply and PC matches.

Baud Rate: 9600 (4800,9600,19200,38400,57600,115200). You can enter the system menu from the front panel, and then set the baud rate.

- Data bits: 8
- Stop Bits: 1
- calibration (none, even, odd)
- EVEN 8 data bits, have even parity
- ODD 8 data bits have odd parity
- NONE 8 data bits, no parity
- MODE: (SIG,MUX)
- SIG a single instrument is connected to the communication
- MUX multiple sets of instrument communication with PC at the same time, in this situation, instrument address must be set to distinguish among all the units(address 0 ~30, default set is 0)

Local Address: (0 ~ 30, the factory default setting is 0)

Parity=None	Start Bit	8 Data Bits	Stop Bit
-------------	-----------	-------------	----------

4.2 USB interface

Use a Cable with two USB port to connect the power and the computer. All power functions can be programmed via USB.

The USB488 interface functions of the power supply described as below:

- interface is 488.2 USB488 interface.
- Interface Receive REN_CONTROL, GO_TO_LOCAL, and









LOCAL_LOCKOUT request.

- Interface receive MsgID = TRIGGER USBTMC order information, and will pass TRIGGER order to the functional layer.

Power USB488 device functions described as follows:

- device can read all of the mandatory SCPI orders.
- device is SR1 enabled.
- device is RL1 enabled.
- device is DT1 enabled.

To communicate via USB interface, you should first select the communication interface as USB in the system menu, the detailed operation is:





1. Press  (Shift)+  to enter the menu.
2. Press  to select SYST SET, and then press , "P-MEM KEEP" is displayed, then press  to select COMM RS232, press .
3. Press  to select USB, and  to confirm.
4. Press  to escape the menu.



NOTE

when communicate via USB interface, only SCPI commands are supported, so you should make sure the LANG(SCPI/FAME) item in the system menu is selected as SCPI, if not, please change to "SCPI". IT6800B series only support SCIP.

4.3 GPIB interface (Only for IT6800B series)

First, Connect the GPIB interface on the power supply and the GPIB card on computer via IEEE488 bus, must be full access and tighten the screws. Then set the address, the address range of the power : 0 to 30, can set by the function key on the front panel, press the  (Shift)+  key to enter the system menu function, find the GPIB address setting by  button, type the address,  key to confirm. GPIB address is stored in nonvolatile memory line.

Chapter5 Specifications

5.1 Specifications

Model		IT6831A	V1.1
Rated Value (0~40 °C)	Voltage	0~18V	
	Current	0~10A	
	Power	180W	
Load regulation ±(% of Output+Offset)	Voltage	≤0.01%+6mV	
	Current	≤0.1%+5mA	
Line regulation ±(% of Output+Offset)	Voltage	≤0.02%+6mV	
	Current	≤0.1%+5mA	
Programming Resolution	Voltage	1mV	
	Current	0.1mA(<10A)/1mA(≥10A)	
Readback resolution	Voltage	1mV	
	Current	0.1mA(<10A)/1mA(≥10A)	
Programming accuracy 12 month (25°C±5°C) ±(% of Output+Offset)	Voltage	≤0.04%+8mV	
	Current	≤0.1%+12mA	
Readback accuracy 12 month (25°C±5°C) ±(% of Output+Offset)	Voltage	≤0.04%+8mV	
	Current	≤0.1%+12mA	
Ripple (20Hz -20MHz)	Voltage	≅4mVp-p and 1.5mVrms	
	Current	≤7mArms	
Setup Temperature Coefficient (% of Output/°C+Offset)	Voltage	0.01%+3mV	
	Current	0.01%+2mA	
Read Back Temperature Coefficient (% of Output/°C+Offset)	Voltage	0.01%+3mV	
	Current	0.01%+2mA	
Rising slope (no load)	Voltage	≤100mS	
Rising slope (full load)	Voltage	≤100mS	
descending slope (no load)	Voltage	≤200mS	
descending slope (full load)	Voltage	≤100mS	
Transient response time	≤100uS (Typical)		
	50%-100% Freq=1K 75mV		
AC Input	Voltage1	110V±10%	
	Voltage3	220V±10%	
	Frequency	47HZ-63HZ	
Setup stability-8h (% of Output +Offset)	Voltage	≅0.02%+3mV	
	Current	≅0.1%+2mA	
Readback stability-8h (% of Output +Offset)	Voltage	≅0.02%+3mV	
	Current	≅0.1%+2mA	
Fuse specification	6.3A(110V)/3.15A(220V)		
Remote Sense Compensation Voltage	1V		

Command Response Time	20mS (Typical)
Power Factor	0.7 (Typical)
Max.Current	4.5A(110V)/2.2A(220V)
Maximum input apparent power	750VA
Storage temperature	-10℃~70℃
Protection	OVP/OTP
Interface	USB/RS232
Isolation (output to ground)	200V
Operation Environment	0~40℃
Dimension (mm)	214.5mmW*88.2mmH*354.6mmD
Weight	7.2Kg

Model		IT6832A	IT6833A
Output Ratings	Voltage / Current	0-32V/0-6A	0-72V/0-3A
Load regulation	Voltage	≤0.01%+5mV	≤0.01%+4mV
	Current	≤0.01%+3mA	≤0.01%+2mA
Line regulation	Voltage	≤0.01%+5mV	≤0.01%+4mV
	Current	≤0.01%+3mA	≤0.01%+2mA
Programming Resolution	Voltage	1mV	1mV
	Current	0.1mA	0.1mA
Readback resolution	Voltage	1mV	1mV
	Current	0.1mA	0.1mA
Programming accuracy 12 month (25℃±5℃)	Voltage	≤0.04%+8mV	≤0.04%+8mV
	Current	≤0.1%+8mA	≤0.1%+5mA
Readback accuracy 12 month (25℃±5℃)	Voltage	≤0.04%+8mV	≤0.04%+8mV
	Current	≤0.1%+8mA	≤0.1%+5mA
Ripple&Noise (20HZ-20M)	Normal mode Voltage	≤4mVp-p and 1mVrms	≤4mVp-p and 1mVrms
	Normal mode Current	<6mArms	<5mArms
	Common mode Current	<1.5uArms	<1.5uArms
Transient response time (Recover to 75mV)	50%-100% load	100us	100us
voltage settling time	rise 10%-90%	<100ms	<150ms
	fall 10%-90%	<350ms	<550ms

Model	IT6832A	IT6833A
Dimension (mm)	214.5mmW*88.2mmH*354.6mmD	
Weight	7.4Kg	

Model	IT6835A	
Rated Value (0~40 °C)	Voltage	0~50V
	Current	0~4A
	Power	200W
Load regulation ±(% of Output+Offset)	Voltage	≤0.01%+5mV
	Current	≤0.1%+3mA
Line regulation ±(% of Output+Offset)	Voltage	≤0.02%+5mV
	Current	≤0.1%+3mA
Programming Resolution	Voltage	1mV
	Current	1mA
Readback resolution	Voltage	1mV
	Current	1mA
Programming accuracy 12 month (25°C±5°C) ±(% of Output+Offset)	Voltage	≤0.04%+8mV
	Current	≤0.1%+8mA
Readback accuracy 12 month (25°C±5°C) ±(% of Output+Offset)	Voltage	≤0.04%+8mV
	Current	≤0.1%+8mA
Ripple (20Hz -20MHz)	Voltage	≅3mVp-p and 1mVrms
	Current	≤6mArms
Setup Temperature Coefficient (% of Output/°C+Offset)	Voltage	0.01%+3mV
	Current	0.01%+2mA
Read Back Temperature Coefficient (% of Output/°C+Offset)	Voltage	0.01%+3mV
	Current	0.01%+2mA
Rising slope (no load)	Voltage	≤100mS
Rising slope (full load)	Voltage	≤100mS
descending slope (no load)	Voltage	≤550mS
descending slope (full load)	Voltage	≤100mS
Transient response time	≤50uS (Typical)	
	50%-100% Freq=1K 75mV	
AC Input	Voltage1	110V±10%
	Voltage3	220V±10%
	Frequen cy	47HZ-63HZ
Setup stability-8h (% of Output +Offset)	Voltage	≅ 0.02%+3mV
	Current	≅ 0.1%+2mA
Readback stability-8h (% of Output +Offset)	Voltage	≅ 0.02%+3mV
	Current	≅ 0.1%+2mA
Remote Sense Compensation Voltage	1V	
Command Response Time	20mS (Typical)	

Fuse specification	6.3A(110V)/3.15A(220V)
Power Factor	0.7 (Typical)
Maximum input apparent power	750VA
Storage temperature	-10°C~70°C
Protection	OVP/OTP
Interface	USB/RS232
Isolation (output to ground)	200V
Operation Environment	0~40°C
Dimension (mm)	214.5mmW*88.2mmH*354.6mmD
Weight	7.2Kg

Model		IT6861A	IT6862A	IT6863A
Output Ratings	Dual range output	0-20V,5A/0-8V,9A	0-32V,3A/0-12V,6A	0-72V,1.5A/0-32V,3A
Load regulation	Voltage	≤0.01%+4mV	≤0.01%+3mV	≤0.01%+3mV
	Current	≤0.01%+2mA	≤0.01%+2mA	≤0.01%+2mA
Line regulation	Voltage	≤0.01%+4mV	≤0.01%+3mV	≤0.01%+3mV
	Current	≤0.01%+2mA	≤0.01%+2mA	≤0.01%+2mA
Programming Resolution	Voltage	1mV	1mV	1mV
	Current	0.1mA	0.1mA	0.1mA
Readback resolution	Voltage	1mV	1mV	1mV
	Current	0.1mA	0.1mA	0.1mA
Programming accuracy 12 month (25°C±5°C)	Voltage	≤0.04%+8mV	≤0.04%+8mV	≤0.04%+8mV
	Current	≤0.1%+5mA	≤0.1%+5mA	≤0.1%+5mA
Readback accuracy 12 month (25°C±5°C)	Voltage	≤0.04%+8mV	≤0.04%+8mV	≤0.04%+8mV
	Current	≤0.1%+5mA	≤0.1%+5mA	≤0.1%+5mA
Ripple (20HZ-20M)	Voltage	≤3mVp-p	≤4mVp-p	≤3mVp-p
	Current	≤9mArms	<7mArms	<6mArms
Transient response time	Recover to 75mV (50%~100%load)	<50uS	<50uS	<50uS
Rise time	10%-90%	<90ms	<90ms	<90ms
Fall time	90%-10%	<150ms	<200ms	<250ms
Sample Rate		10HZ/S	10HZ/S	10HZ/S
Protection		OTP;OVP	OTP;OVP	OTP;OVP
Dimension(mm)		214.5mmW*88.2mmH*354.6mmD		
Weight		8.5Kg		

Model		IT6872A
Output Ratings	Dual range output	0-35V,4A /0-15V,7A

Load regulation	Voltage	$\leq 0.01\% + 5\text{mV}$
	Current	$\leq 0.01\% + 3\text{mA}$
Line regulation	Voltage	$\leq 0.01\% + 5\text{mV}$
	Current	$\leq 0.01\% + 3\text{mA}$
Programming Resolution	Voltage	1mV
	Current	0.1mA
Readback resolution	Voltage	1mV
	Current	0.1mA
Programming accuracy 12 month (25°C±5°C)	Voltage	$\leq 0.04\% + 8\text{mV}$
	Current	$\leq 0.1\% + 5\text{mA}$
Readback accuracy 12 month (25°C±5°C)	Voltage	$\leq 0.04\% + 8\text{mV}$
	Current	$\leq 0.1\% + 5\text{mA}$
Ripple&Noise (20HZ-20M)	Normal mode Voltage	$\leq 3\text{mVp-p} / 1\text{mVrms}$
	Normal mode Current	$< 6\text{mA rms}$
	Common mode Current	$< 1.5\text{uA rms}$
Transient response time	Recover to 75mV (50%~100%load)	$< 50\text{us}$
Rise time	10%-90%	$< 90\text{ms}$
Fall time	90%-10%	$< 350\text{ms}$
Dimension(mm)		214.5mmW*88.2mmH*354.6mmD
Weight		7.1Kg

Model	IT6873A	
Output Ratings (0 °C~40 °C)	Voltage	H:0-75V L:0-32V
	Current	H:0-2A L:0-4A
	Power	H:150W L:128W
Load regulation ±(% of output+offset)	Voltage	$\leq 0.01\% + 4\text{mV}$
	Current	$\leq 0.01\% + 2\text{mA}$
Line regulation ±(% of output+offset)	Voltage	$\leq 0.01\% + 4\text{mV}$
	Current	$\leq 0.01\% + 2\text{mA}$

Programming Resolution	Voltage	1mV
	Current	0.1mA
Readback resolution	Voltage	1mV
	Current	0.1mA
Programming accuracy 12 month (25°C±5°C)	Voltage	≤0.04%+8mV
	Current	≤0.1%+5mA
Readback accuracy 12 month (25°C±5°C)	Voltage	≤0.04%+8mV
	Current	≤0.1%+5mA
Ripple (20Hz ~20MHz)	Voltage	≤3mVp-p/1mVrms
	Current	≤6mA _{rms}
Rise time	Voltage	≤120mS(10%-90%)
Fall time	Voltage	≤450m(90%-10%)
Transient response time	Voltage	50us (50%-100% load Recover to 75mV)
Sample rate	10HZ/S	
Protection	OTP;OVP	
Dimension (mm)	214.5mmW×88.2mmH×354.6mmD	
Weight	8.5Kg	

Model		IT6874A
Output Ratings (0 °C~40 °C)	Voltage	H:0-150V L:0-60V
	Current	H:0-1.2A L:0-2A
	Power	H:180W L:120W
Load regulation ±(% of	Voltage	≤0.01%+4mV

output+offset)	Current	$\leq 0.01\% + 2\text{mA}$
Line regulation $\pm(\%$ of output+offset)	Voltage	$\leq 0.01\% + 4\text{mV}$
	Current	$\leq 0.01\% + 2\text{mA}$
Programming Resolution	Voltage	1mV(<100V) 10mV($\geq 100\text{V}$)
	Current	0.1mA
Readback resolution	Voltage	1mV(<100V) 10mV($\geq 100\text{V}$)
	Current	0.1mA
Programming accuracy 12 month (25°C $\pm 5^\circ\text{C}$)	Voltage	$\leq 0.05\% + 20\text{mV}$
	Current	$\leq 0.1\% + 5\text{mA}$
Readback accuracy 12 month (25°C $\pm 5^\circ\text{C}$)	Voltage	$\leq 0.05\% + 20\text{mV}$
	Current	$\leq 0.1\% + 5\text{mA}$
Ripple (20Hz ~20MHz)	Voltage	$\leq 5\text{mVp-p}/1.5\text{mVrms}$
	Current	$\leq 6\text{mA}_{\text{rms}}$
Rise time	Voltage	$\leq 150\text{ms}(10\%-90\%)$
Fall time	Voltage	$\leq 2.5\text{s}(90\%-10\%)$
Transient response time	Voltage	100us (50%-100% load Recover to 75mV)
Sample rate	10HZ/S	
Protection	OTP;OVP	
Dimension (mm)	214.5mmWx88.2mmHx354.6mmD	
Weight	8.5Kg	

Model		IT6832B	IT6833B
Output Ratings	Voltage / Current	0-32V/0-6A	0-72V/0-3A
Load regulation	Voltage	$\leq 0.01\% + 5\text{mV}$	$\leq 0.01\% + 4\text{mV}$

	Current	$\cong 0.01\%+3\text{mA}$	$\cong 0.01\%+2\text{mA}$
Line regulation	Voltage	$\cong 0.01\%+5\text{mV}$	$\cong 0.01\%+4\text{mV}$
	Current	$\cong 0.01\%+3\text{mA}$	$\cong 0.01\%+2\text{mA}$
Programming Resolution	Voltage	1mV	1mV
	Current	0.1mA	0.1mA
Readback resolution	Voltage	1mV	1mV
	Current	0.1mA	0.1mA
Programming accuracy 12 month (25°C±5°C)	Voltage	$\cong 0.04\%+8\text{mV}$	$\cong 0.04\%+8\text{mV}$
	Current	$\cong 0.1\%+8\text{mA}$	$\cong 0.1\%+5\text{mA}$
Readback accuracy 12 month (25°C±5°C)	Voltage	$\cong 0.04\%+8\text{mV}$	$\cong 0.04\%+8\text{mV}$
	Current	$\cong 0.1\%+8\text{mA}$	$\cong 0.1\%+5\text{mA}$
Ripple&Noise (20HZ-20M)	Normal mode Voltage	$\cong 4\text{mVp-p}$ and 1mVrms	$\cong 4\text{mVp-p}$ and 1mVrms
	Normal mode Current	<6mArms	<5mArms
	Common mode Current	<1.5uArms	<1.5uArms
Transient response time (Recover to 75mV)	50%-100% load	100us	100us
Voltage settling time	rise 10%-90%	<100ms	<150ms
	fall 10%-90%	<350ms	<550ms
Dimension (mm)	214.5mmW*88.2mmH*354.6mmD		
Weight	7.1Kg		7.7Kg

Model		IT6835B
Rated Value (0~40 °C)	Voltage	0~50V
	Current	0~4A
	Power	200W
Load regulation ±(%of Output+Offset)	Voltage	$\leq 0.01\%+5\text{mV}$
	Current	$\leq 0.1\%+3\text{mA}$
Line regulation ±(%of Output+Offset)	Voltage	$\leq 0.02\%+5\text{mV}$
	Current	$\leq 0.1\%+3\text{mA}$
Programming Resolution	Voltage	1mV
	Current	1mA
Readback resolution	Voltage	1mV
	Current	1mA
Programming accuracy 12 month (25°C±5°C)	Voltage	$\leq 0.04\%+8\text{mV}$
	Current	$\leq 0.1\%+8\text{mA}$

±(% of Output+Offset)		
Readback accuracy 12 month (25°C±5°C) ±(% of Output+Offset)	Voltage	≤0.04%+8mV
	Current	≤0.1%+8mA
Ripple (20Hz -20MHz)	Voltage	≅3mVp-p and 1mVrms
	Current	≤6mArms
Setup Temperature Coefficient (% of Output/°C +Offset)	Voltage	0.01%+3mV
	Current	0.01%+2mA
Read Back Temperature Coefficient (% of Output/°C +Offset)	Voltage	0.01%+3mV
	Current	0.01%+2mA
Rising slope (no load)	Voltage	≤100mS
Rising slope (full load)	Voltage	≤100mS
descending slope (no load)	Voltage	≤550mS
descending slope (full load)	Voltage	≤100mS
Transient response time	≤50uS (Typical)	
	50%-100% Freq=1K 75mV	
AC Input	Voltage1	110V±10%
	Voltage3	220V±10%
	Frequency	47HZ-63HZ
Setup stability-8h (% of Output +Offset)	Voltage	≅0.02%+3mV
	Current	≅0.1%+2mA
Readback stability-8h (% of Output +Offset)	Voltage	≅0.02%+3mV
	Current	≅0.1%+2mA
Remote Sense Compensation Voltage	1V	
Command Response Time	20mS (Typical)	
Fuse specification	6.3A(110V)/3.15A(220V)	
Power Factor	0.7 (Typical)	
Maximum input apparent power	750VA	
Storage temperature	-10°C~70°C	
Protection	OVP/OTP	
Interface	GPIB/USB/RS232	
Isolation (output to ground)	200V	
Operation Environment	0~40°C	
Dimension (mm)	214.5mmW*88.2mmH*354.6mmD	
Weight	7.2Kg	

Model		IT6861B	IT6862B	IT6863B
Output	Dual range	0-20V,5A/0-8V,9A	0-32V,3A/0-12V,6A	0-72V,1.5A/0-32V,3A

Ratings	output			
Load regulation	Voltage	≤0.01%+4mV	≤0.01%+3mV	≤0.01%+3mV
	Current	≤0.01%+2mA	≤0.01%+2mA	≤0.01%+2mA
Line regulation	Voltage	≤0.01%+4mV	≤0.01%+3mV	≤0.01%+3mV
	Current	≤0.01%+2mA	≤0.01%+2mA	≤0.01%+2mA
Programming Resolution	Voltage	1mV	1mV	1mV
	Current	0.1mA	0.1mA	0.1mA
Readback resolution	Voltage	1mV	1mV	1mV
	Current	0.1mA	0.1mA	0.1mA
Programming accuracy 12 month (25°C±5°C)	Voltage	≤0.04%+8mV	≤0.04%+8mV	≤0.04%+8mV
	Current	≤0.1%+5mA	≤0.1%+5mA	≤0.1%+5mA
Readback accuracy 12 month (25°C±5°C)	Voltage	≤0.04%+8mV	≤0.04%+8mV	≤0.04%+8mV
	Current	≤0.1%+5mA	≤0.1%+5mA	≤0.1%+5mA
Ripple (20HZ-20M)	Voltage	≤3mVp-p	≤4mVp-p	≤3mVp-p
	Current	≤9mArms	≤7mArms	≤6mArms
Transient response time	Recover to 75mV (50%~100%load)	<50uS	<50uS	<50uS
Rise time	Voltage	≤90mS(10%-90%)	≤90mS(10%-90%)	≤90mS(10%-90%)
Fall time	Voltage	≤150m(90%-10%)	≤200m(90%-10%)	≤250m(90%-10%)
Sample rate		10HZ/S	10HZ/S	10HZ/S
Protection		OTP;OVP	OTP;OVP	OTP;OVP
Dimension (mm)		214.5mmW*88.2mmH*354.6mmD		
Weight		8.5Kg		

Model		IT6872B	IT6873B
Output Ratings	Dual range output	0-35V,4A /0-15V,7A	0-75V,2A /0-32V,4A
Load regulation	Voltage	≤0.01%+5mV	≤0.01%+4mV
	Current	≤0.01%+3mA	≤0.01%+2mA
Line regulation	Voltage	≤0.01%+5mV	≤0.01%+4mV
	Current	≤0.01%+3mA	≤0.01%+2mA
Programming Resolution	Voltage	1mV	1mV
	Current	0.1mA	0.1mA
Readback resolution	Voltage	1mV	1mV
	Current	0.1mA	0.1mA
Programming accuracy 12 month (25°C±5°C)	Voltage	≤0.04%+8mV	≤0.04%+8mV
	Current	≤0.1%+5mA	≤0.1%+5mA
Readback accuracy 12 month	Voltage	≤0.04%+8mV	≤0.04%+8mV
	Current	≤0.1%+5mA	≤0.1%+5mA

(25°C±5°C)			
Ripple&Noise	Normal mode Voltage	≤3mVp-p /1mVrms	≤3mVp-p /1mVrms
	Normal mode Current	<6mArms	<6mArms
	Common mode Current	<1.5uArms	<1.5uArms
Transient response time	Recover to 75mV (50%~100%load)	<50us	<50us
Rise time	10%-90%	<90ms	<120ms
Fall time	90%-10%	<350ms	<450ms

Model		IT6874B	
Output Ratings (0 °C~40 °C)	Voltage	H:0-150V	L:0-60V
	Current	H:0-1.2A	L:0-2A
	Power	H:180W	L:120W
Load regulation ±(% of output+offset)	Voltage	≤0.01%+4mV	
	Current	≤0.01%+2mA	
Line regulation ±(% of output+offset)	Voltage	≤0.01%+4mV	
	Current	≤0.01%+2mA	
Programming Resolution	Voltage	1mV(<100V) 10mV(≥ 100V)	
	Current	0.1mA	
Readback resolution	Voltage	1mV(<100V) 10mV(≥ 100V)	
	Current	0.1mA	
Programming accuracy 12 month (25°C±5°C)	Voltage	≤0.05%+20mV	
	Current	≤0.1%+5mA	
Readback accuracy 12 month (25°C±5°C)	Voltage	≤0.05%+20mV	
	Current	≤0.1%+5mA	
Ripple (20Hz ~20MHz)	Voltage	≤5mVp-p/1.5mVrms	

	Current	≤6mArms
Rise time	Voltage	≤150ms(10%-90%)
Fall time	Voltage	≤2.5s(90%-10%)
Transient response time	Voltage	100us (50%-100% load Recover to 75mV)
Sample rate	10HZ/S	
Protection	OTP;OVP	
Dimension (mm)	214.5mmW×88.2mmH×354.6mmD	
Weight	8.5Kg	

The above specifications may be subject to change without prior notice.

5.2 Supplementary Characteristics

Memory capacity:9*8 registeres

Suggested calibration frequency:Once a year

AC input level(A transfer switch is selectable on the rear panel)

Option Opt.01: 220VAC ± 10%, 47 to 63 Hz

Option Opt.02: 110 VAC ± 10%, 47 to 63 Hz

Cooling type

Intelligent fans

Appendix

Specifications of Red and Black Test Lines

ITECH provides you with optional red and black test lines, which individual sales and you can select for test. For specifications of ITECH test lines and maximum current values, refer to the table below.

Model	Specification	Cross Section	Length
IT-E301/10A	10A	-	1m
IT-E301/30A	30A	6mm ²	1.2m
IT-E301/30A	30A	6mm ²	2m
IT-E301/60A	60A	20mm ²	1.5m
IT-E301/120A	120A	50mm ²	2m
IT-E301/240A	240A	70mm ²	1m
IT-E301/240A	240A	70mm ²	2m
IT-E301/360A	360A	95mm ²	2m

For maximum current of AWG copper wire, refer to table blow.

AWG	10	12	14	16	18	20	22	24	26	28
The Maximum Current Value(A)	40	25	20	13	10	7	5	3.5	2.5	1.7

Note: AWG (American Wire Gage), it means X wire (marked on the wire). The table above lists current capacity of single wire at working temperature of 30°C. For reference only.

No output

Please check the status of current in SET whether it is zero; if it is set as zero, please modify to non-zero value; if still no output, please connect ITECH directly.

How to avoid it couldn't start when test battery

When test battery, the main reason of no start is that battery (residual voltage) discharges capacitors of positive and negative terminals of the power supply.

Method to avoid no start: connect a switch which is parrallel with a current limiting discharging resistor. Close the switch after all the all leads connected well. The wiring diagram as follows:

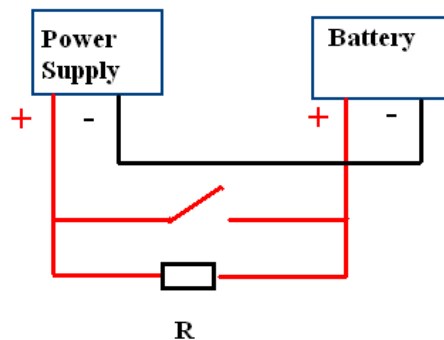

Contact Us

Thanks for purchasing ITECH products. In case of any doubts, please contact us as follows:

1. Visit ITECH website: www.itechate.com.
2. Select the most convenient contact method for further information.