

A GREATER MEASURE OF CONFIDENCE

**KEITHLEY**  
A Tektronix Company



# Source Measure Unit Instruments

*The Tool of Choice for Emerging R&D Applications*

**KEITHLEY**  
A Tektronix Company

# What is a Source Measure Unit (SMU) Instrument?

A source measure unit (SMU) instrument is a type of test equipment that is capable of both sourcing and measuring simultaneously to a device under test (DUT.)



SMU instruments are a smart alternative to separate power supplies and digital multimeters (DMMs,) and they have a convenient DMM-like user interface. Keithley SMU instruments combine a power supply, true current source, 6.5-digit DMM, arbitrary waveform generator, V or I pulse generator with measurement, electronic load, and trigger controller – all in one instrument.

SMU instruments can:

- Simultaneously source voltage or current and measure voltage and/or current
- Source and measure across 10 decades of current and 5 decades of voltage
- Perform resistance measurements using programmable force voltage or force current values

SMU instruments are typically used on an R&D bench or in automatic test systems in both labs and manufacturing operations to perform IV characterization.

## Meet Keithley's Entire SourceMeter SMU Instrument Family



**What is an SMU instrument and how do you decide which one is right for your application?**  
[Download the white paper now to find out.](#)

**Want assistance, a quote, or to place an order?**  
[Contact us online.](#)

- Join the discussion on our [application forum](#).

# SMU Instruments vs. DMMs and Power Supplies

Virtually every digital multimeter (DMM) includes some basic SMU instrument concept in its ohms function, where a built-in, fixed, current source is applied to the unknown resistance, the voltage developed across it is measured, and the resistance value is then calculated using Ohm's Law ( $R = E/I$ ). A Keithley SourceMeter SMU instrument takes the concept to a much higher level of flexibility for characterizing, evaluating, and testing a wider range of devices over a much wider range of applied stimulus, either current or voltage.

A SourceMeter SMU instrument has a four-quadrant, precision source, which means it can source current or voltage depending on the settings and load and can go from maximum positive output to maximum negative output without changing test leads. Four-quadrant capability also means the SourceMeter SMU instrument can "sink" current, as when taking current from a device under test (DUT) such as a solar cell, charged capacitor, or power supply, where the SourceMeter SMU instrument acts as a precision, controlled load, with the resulting DUT voltage being measured at the same time.

One of the simplest applications for a SourceMeter SMU instrument is in testing diodes, where a series of constant current or voltage steps (sweep) is applied to test the forward characteristics and a sweep of constant voltage is typically used to test the reverse leakage and breakdown parameters.

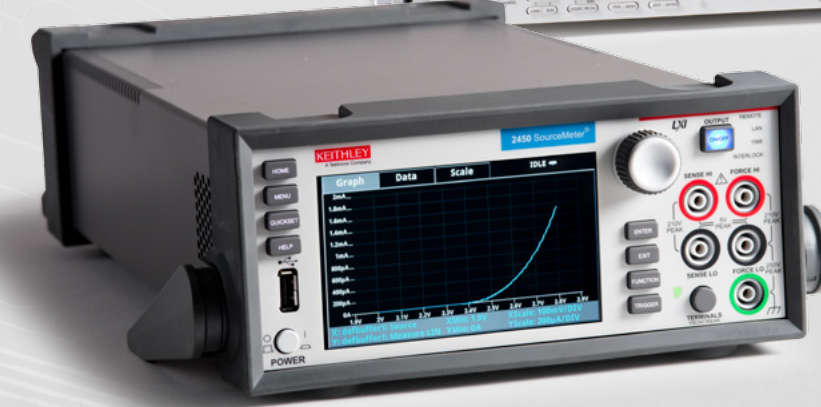
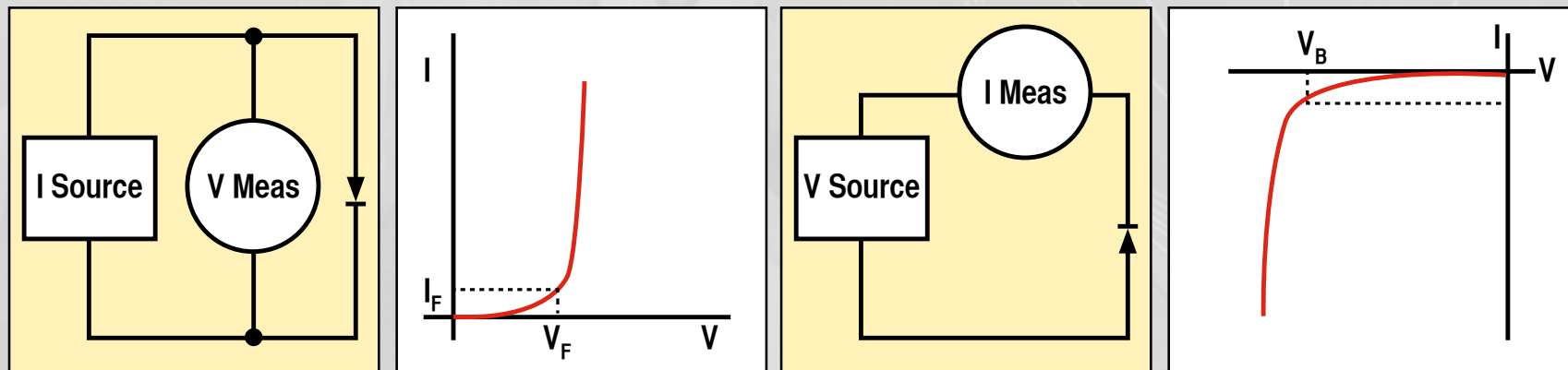
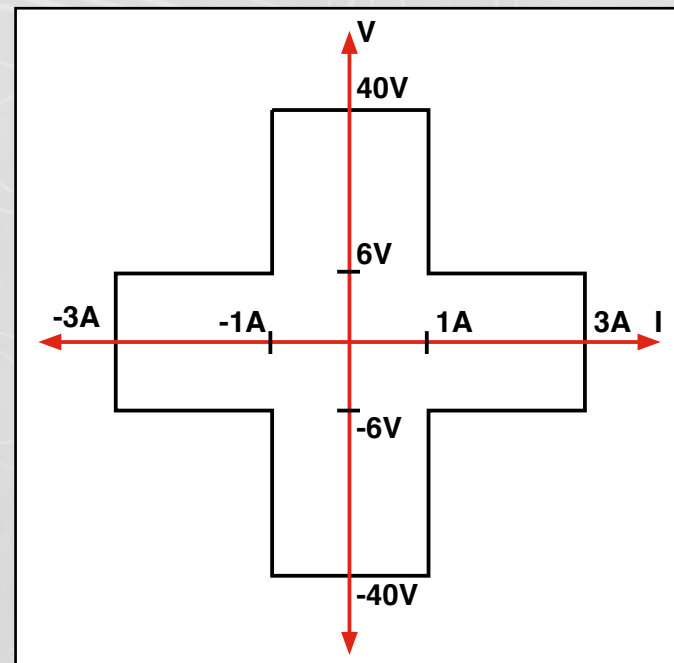

View a short introduction of the **NEW** Model 2450 Advanced Touchscreen SourceMeter SMU Instrument.

Want assistance, a quote, or to place an order?  
[Contact us online.](#)

■ Join the discussion on our [application forum.](#)

# Choosing the Keithley SourceMeter® SMU Instrument for Your Application

Keithley has three SourceMeter SMU Instrument families, the Series 2400, the Series 2600B, and the NEW 2450 Touchscreen SourceMeter SMU instrument. Series 2400 and 2450 SourceMeter SMU instruments are ideal for lab/bench R&D applications. These models are single channel only and have a DMM and power supply look and feel.

[Learn more about the Model 2450 Touchscreen SourceMeter® SMU instrument](#)

[Learn more about the Series 2400 SourceMeter SMU Instruments.](#)

[Learn more about the Series 2600B System SourceMeter SMU instruments](#)

Series 2600B System SourceMeter SMU instruments are designed for high speed test in production applications, manufacturing, and high density lab systems. The Series 2600B are available in either single or dual channel models for reduced space in a rack based system.



For an expanded view of Keithley SourceMeter SMU instruments beyond R&D tools for lab/bench applications, read Keithley's e-guide on how to select a SMU instrument.



2400 Series & Model 2450

Automated Lab Systems

2600 Series



Want assistance, a quote, or to place an order?  
[Contact us online.](#)

Join the discussion on our [application forum.](#)

# R&D Applications for Keithley SourceMeter® SMU Instruments

There is a never-ending need for better materials and components/devices driven by nanotechnology, energy conversion and generation, advanced low power and high power lighting, and advances in health care and diagnostics. The increase in research for emerging materials and devices begets new users performing current-voltage characterization in research, education, development, and early-phase device environments. Whether

advancing technology in nanoscience, semiconductors, or the boundaries of chemistry/electrochemistry, your success hinges on ultimate measurement reliability and a high degree of confidence that you're getting accurate and valid data. That's why electrical engineers, materials scientists, chemists, electro-chemists, and biologists alike have turned to Keithley SourceMeter SMU instruments for their most challenging applications.

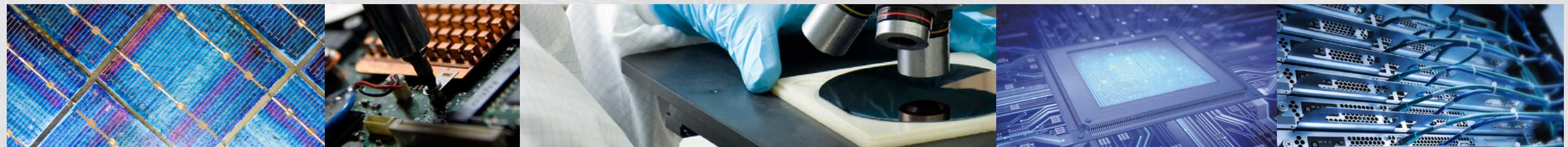

R&D/Bench Application	Facility Type	Who
Nanotechnology	Universities	Test Engineers
Low power semiconductors	Government Research Labs	Physicists
LED/OLED/AMOLED	Industry R&D Labs	Chemists (new)
Photovoltaics	Metrology Labs	Biologists (new)
Printed/Organic Electronics		Electrochemists (new)
Design Validation, Debug		Design Engineers
Electrochemistry		Hardware Engineers
Biotechnology		Graduate Engineers



**Guide to Measuring New Materials and Devices**

Want assistance, a quote, or to place an order?  
[Contact us online.](#)

■ [Join the discussion on our application forum.](#)

# R&D Applications for Keithley SourceMeter® SMU Instruments



## Nanotechnology

There is a trend in nanotechnology that is moving beyond CMOS (nano-tech) electronics. Graphene-based electronics (transparent conductors, flexible displays, touch screens), memristor memory, nano-enabled implantables, nano-piezos (energy), sensors, etc. are new areas in nanoscience research.

SMU instruments can be used in nanoscience applications like advanced materials resistance, resistivity, Hall Effect, Quantum Hall, and related IVR measurements.

### SMU instruments are practical across the entire nanotechnology

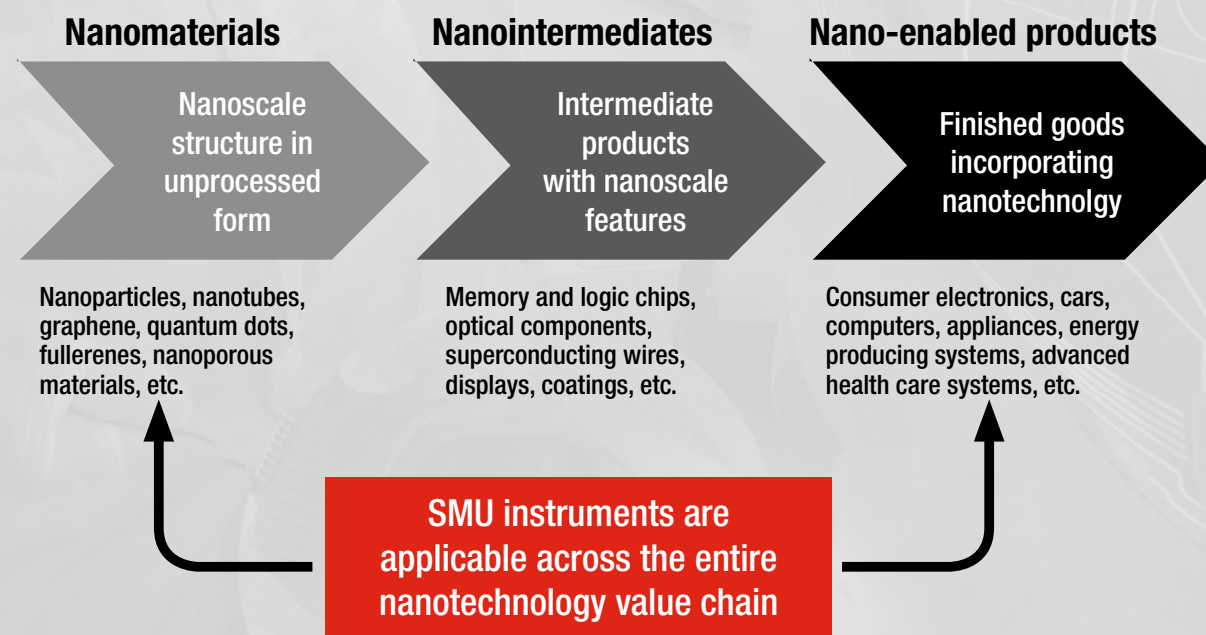

## Semiconductor testing

Memory (NAND Flash and DRAM memory), microprocessors and analogue, optoelectronics - sensors - discrete (O-S-D) devices, tablet computers, smartphones, and a wide array of other portable wireless devices will keep semiconductor units growing at a steady pace through 2016. And, SMU instruments are being used in each of these areas to test and characterize diodes, transistors, LEDs, photovoltaic cells, silicon sensors for IV characterization, or resistance/resistivity measurements.

An important advantage of many SMU instruments is their source-level sweeping or stepping capability. Either voltage or current can be stepped across the desired range at specified increments, and the resulting current or voltage can be measured at each step. Unlike a DMM, which can make a measurement at only one point, a SMU instrument can be used to generate a family of I-V curves, because it has a built-in source. This is especially useful when studying semiconductor devices and making materials measurements typically performed across many decades of voltage or current.

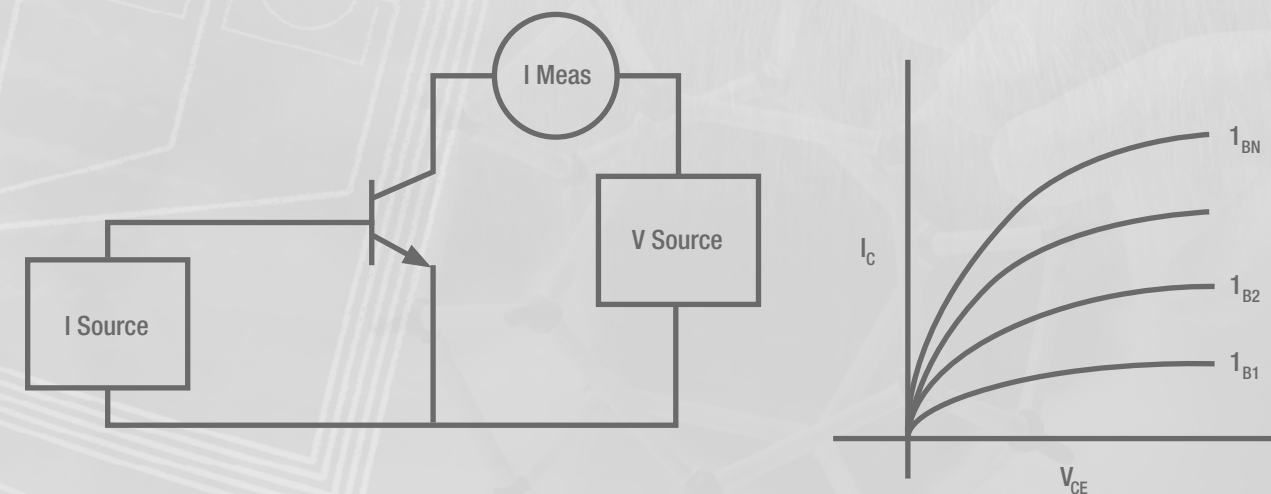

Discover Today's Solutions for Tomorrow's Nano Characterization Challenges

E-Guide to Solving Today's Material and Device Characterization Challenges

# R&D Applications for Keithley SourceMeter® SMU Instruments

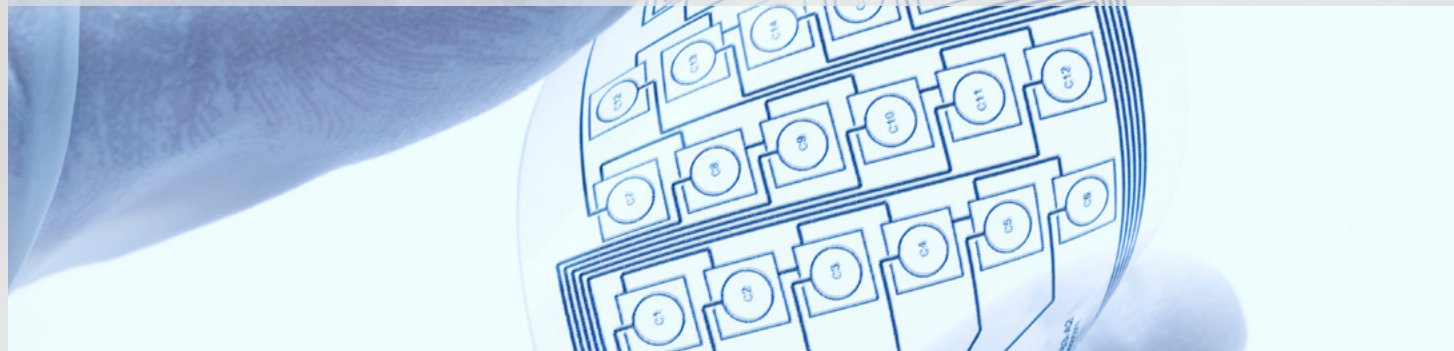

## Organic and Printed Electronics

There is an increasing trend of using e-paper displays, OLEDs, organic transistors & memory, thin film / organic photovoltaics and printed electronics. However, there are limitations for organic materials and devices compared to silicon technology. Organic materials based on small molecules do not lend themselves to solution processing of any kind. There is a need for new inks that can be used in the process of printing organic electronics. Organic conductors must have large conductivities for the realization of source/drain contacts and need to have high charge carrier mobilities and high  $I_{on}/I_{off}$  ratios to ensure high current values and low leakages. Also, high- $\kappa$  materials are needed for gate dielectrics and low- $\kappa$  dielectrics are needed as organic insulating materials. With these come the need for I-V and resistivity testing, for which a SMU instrument is an ideal solution.

## Energy Production & Consumption

The growing demand for efficient energy production and management means more focus on green sources of energy like solar panels and wind turbines. The demand for efficiency management in motor drivers, lighting, and power supplies is rising, which in turn drives the use of thin film and light trapping PVs, nano-enabled solar cells, large area solar cells, and advanced LED/OLEDs. There is a test requirement for PV efficiency/lifetime/quality characterization and battery-powered device drain/charge testing for which SMUs could be used.

## Discover the Industry Standard for LED Electrical Test Simplify Your Solar Cell Testing with Keithley's Precision Measurement Solutions

Learn more about Solar Cell Testing. View the webinar  
Understanding Electrical Characterization of Solar Cells.

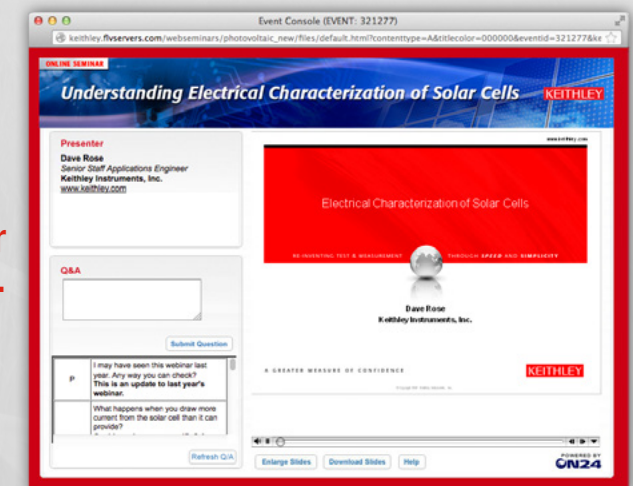

View the webinar **Understanding Electrical Characterization of Printed and Organic Electronics and Materials** to learn more.

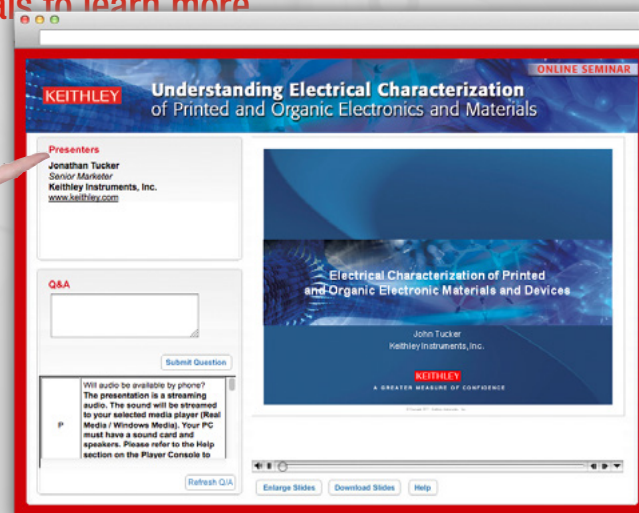

Want assistance, a quote, or to place an order?  
Contact us online.

Join the discussion on our [application forum](#).

# System SourceMeter® SMU Instruments Selector Guide



Feature	6430 Low I SourceMeter	2430 High Power SourceMeter Instrument	2410 High V SourceMeter Instrument	2420 / 2425 / 2440 High I SourceMeter Instruments	2400 / 2401 Low Power SourceMeter Instruments	2450 Touchscreen SourceMeter Instrument
<b>Current Max / Min</b>	105mA / 10aA	10.5A pulse / 100pA	1.05A / 10pA	5.25A/ 100pA	1.05A / 10pA	.05A/10nA
<b>Voltage Max / Min</b>	200V / 1uV	200V / 1uV	1100V / 1uV	100V / 1uV	200V / 1uV	200V/20mA
<b>Power</b>	2W	1100W	22W	110W	22W	20W
<b>Max readings / sec</b>	256	2,000	2,000	2,000	2,000	3,100
<b>Interface</b>	GPIB, RS-232, Digital I/O, Trigger Link Trigger Bus	GPIB, RS-232, Digital I/O, Trigger Link Trigger Bus	GPIB, RS-232, Digital I/O, Trigger Link Trigger Bus	GPIB, RS-232, Digital I/O, Trigger Link Trigger Bus	GPIB, RS-232, Digital I/O, Trigger Link Trigger Bus	GPIB, USB, LAN/LXI, Digital I/O, TSP-Link
<b>Connectors</b>	Triax	Banana (front / rear)	Banana (front / rear)	Banana (front / rear)	Banana (front / rear)	Banana (front) Triax (rear)

Want assistance, a quote, or to place an order?

[Contact us online.](#)

■ [Join the discussion on our application forum.](#)



Want to learn more about applications for Keithley's growing family of SMU instruments?



Keithley Instruments hosts an online applications forum to encourage idea exchange and discussions among users. [Join the conversation today.](#)

To learn more about how Keithley's high performance SMUs can enhance the productivity of your test and measurement applications, contact your local Keithley representative or [ask us a question online.](#)

## Contact us by phone, fax, mail, or email:

### KEITHLEY CORPORATE HEADQUARTERS

Keithley Instruments, Inc.  
28775 Aurora Road  
Cleveland, Ohio 44139  
Phone: 440-248-0400  
Toll-free: 800-552-1115  
Fax: 440-248-6168  
[info@keithley.com](mailto:info@keithley.com)

Consult with a Keithley applications engineer and learn how to get the most from your Keithley products

### WORLDWIDE HEADQUARTERS

Within the USA: 1-888-534-8453  
Outside the USA: + 1-440-248-0400  
Email: [applications@keithley.com](mailto:applications@keithley.com)  
Additional contact information at [www.keithley.com](http://www.keithley.com)

### EUROPE

Germany: (+49) 89 84 93 07 40

### ASIA

China: (+86) 10 8447 5556  
Japan: (+81) 120 441 046  
Korea: (+82) 2 6917 5000  
Taiwan: (+886) 3 572 9077



Specifications are subject to change without notice.

All Keithley trademarks and trade names are the property of Keithley Instruments, Inc.  
All other trademarks and trade names are the property of their respective companies.

A Greater Measure of Confidence

**KEITHLEY**

A Tektronix Company

KEITHLEY INSTRUMENTS, INC. ■ 28775 AURORA RD. ■ CLEVELAND, OH 44139-1891 ■ 440-248-0400 ■ Fax: 440-248-6168 ■ 1-888-KEITHLEY ■ [www.keithley.com](http://www.keithley.com)

#### BENELUX

+31-40-267-5506  
[www.keithley.nl](http://www.keithley.nl)

#### FRANCE

+33-01-69-86-83-60  
[www.keithley.fr](http://www.keithley.fr)

#### ITALY

+39-049-762-3950  
[www.keithley.it](http://www.keithley.it)

#### MALAYSIA

60-4-643-9679  
[www.keithley.com](http://www.keithley.com)

#### SINGAPORE

01-800-8255-2835  
[www.keithley.com.sg](http://www.keithley.com.sg)

#### BRAZIL

55-11-4058-0229  
[www.keithley.com](http://www.keithley.com)

#### GERMANY

+49-89-84-93-07-40  
[www.keithley.de](http://www.keithley.de)

#### JAPAN

81-120-441-046  
[www.keithley.jp](http://www.keithley.jp)

#### MEXICO

52-55-5424-7907  
[www.keithley.com](http://www.keithley.com)

#### TAIWAN

886-3-572-9077  
[www.keithley.com.tw](http://www.keithley.com.tw)

#### CHINA

86-10-8447-5556  
[www.keithley.com.cn](http://www.keithley.com.cn)

#### INDIA

080-30792600  
[www.keithley.in](http://www.keithley.in)

#### KOREA

82-2-6917-5000  
[www.keithley.co.kr](http://www.keithley.co.kr)

#### RUSSIA

+7-495-664-7564  
[www.keithley.ru](http://www.keithley.ru)

#### UNITED KINGDOM

+44-1344-39-2450  
[www.keithley.co.ukw](http://www.keithley.co.ukw)

For further information on how to purchase or to locate a sales partner please visit [www.keithley.com/company/buy](http://www.keithley.com/company/buy)

# Selector Guide

SourceMeter® SMU Instruments

# Selector Guide

SourceMeter® SMU Instruments

Selector guide: Source Measure Unit (SMU) Instruments

Selector guide: Source Measure Unit (SMU) Instruments

	20-100W BENCH SMU INSTRUMENTS					20-100W SYSTEM SMU INSTRUMENTS	20-100W SYSTEM SMU INSTRUMENTS	100-200W POWER SMU INSTRUMENTS			LOW CURRENT SMU INSTRUMENTS	
MODEL	2400, 2401 2400-C 2400-LV	2410 2410-C	2420 2420-C	2425 2425-C	2440 2440-C	2601B 2602B 2604B	2611B 2612B 2614B	2430 2430-C	2651A	2657A	2634B 2635B 2636B	6430
<b>POWER OUTPUT</b>	22 W	22 W	66 W	110W	55 W	40 W/channel	30 W/channel	1100 W <sup>1</sup>	2,000W pulsed/200W DC	180 W	30 W/channel	2 W
<b>CURRENT CAPABILITY</b>												
Min.	±1 pA	±1 pA	±10 pA	±10 pA	±10 pA	±100 fA	±100 fA	±10 pA	±100 fA	±1 fA	±0.1 fA (2635B, 2636B) ±1 fA (2634B)	±10 aA
Max	±1.05 A	±1.05 A	±3.15 A	±3.15 A	±5.25 A	±3 A DC/10 A pulsed per channel	±1.5 A DC/10 A pulsed per channel	±10.5 A <sup>1</sup>	±50A (±100 A when two units are connected in parallel)	±120 mA	±1.5 A DC/10 A pulsed per channel	±105 mA
<b>VOLTAGE CAPABILITY</b>												
Min.	±100 nV	±100 nV	±100 nV	±100 nV	±100 nV	±100 nV	±100 nV	±100 nV	±100 nV	±100 nV	±100 nV	±1 μV
Max.	±21/±210 V <sup>2</sup>	±1100 V	±63 V	±105 V	±42 V	±40 V	±200 V	±105 V	±40 V	±3000 V	±200 V	±210 V
<b>OHMS RANGE<sup>3</sup></b>	<0.2 Ω to >200 MΩ	<0.2 Ω to >200 MΩ	<0.2 Ω to >200 MΩ	<0.2 Ω to >200 MΩ	<2.0 Ω to >200 MΩ	0.5 μΩ to 40 TΩ	0.5 μΩ to 100 TΩ	<0.2 Ω to >200 MΩ	<0.1 μΩ to 20 TΩ	<0.4 Ω to 100 PΩ	0.5 μΩ to 10 PΩ	<2.0 Ω to >20 TΩ
<b>BASIC ACCURACY</b>												
I	0.035%	0.035%	0.035%	0.035%	0.035%	0.02 %	0.02 %	0.035%	0.02 %	0.02 %	0.02 %	0.035%
V	0.015%	0.015%	0.015%	0.015%	0.015%	0.015%	0.015%	0.015%	0.015%	0.015%	0.015%	0.012%
Ω	0.06 %	0.07 %	0.06 %	0.06 %	0.06 %	Based on V and I range	Based on V and I range	0.06 %	Based on V and I range	Based on V and I range	Based on V and I range	0.063%
<b>READING SPEED</b>	2,800 rdgs/s	2,800 rdgs/s	2,800 rdgs/s	2,800 rdgs/s	2,800 rdgs/s	20,000 rdgs/s	20,000 rdgs/s	2,800 rdgs/s	20,000 rdgs/s and 1μs per pt digitizer	20,000 rdgs/s and 1μs per pt digitizer	20,000 rdgs/s	2,000 rdgs/s
<b>FEATURE SUMMARY</b>												
Pulse Mode	No	No	No	No	No	Yes	Yes	Yes	Yes	Yes	Yes	No
Embedded Scripting/Execution	Source-Memory List	Source-Memory List	Source-Memory List	Source-Memory List	Source-Memory List	Test Script Processor (TSP®) Technology	Test Script Processor (TSP®)	Source-Memory List	Test Script Processor (TSP®)	Test Script Processor (TSP®)	Test Script Processor (TSP®)	Source-Memory List
Contact Check	-C version	-C version	-C version	-C version	-C version	Yes (not available for 2604B)	Yes (not available for 2614B)	-C version	Yes	Yes	Yes (not available for 2634B)	No
Selectable Front/Rear Inputs	Yes	Yes	Yes	Yes	Yes	Rear only	Rear only	Yes	Rear only	Rear Only	Rear only	Rear and Preamp
Test Leads/Cables	Banana	Banana	Banana	Banana	Banana	Screw terminal; adapters available for banana /or triax	Screw terminal; adapters available for banana /or triax	Banana	Screw terminal; adapters available for banana /or triax	HV triax	Triax	Triax
Computer Interface	IEEE-488, RS-232	IEEE-488, RS-232	IEEE-488, RS-232	IEEE-488, RS-232	IEEE-488, RS-232	USB 2.0, LAN/LXI-C, IEEE-488, RS-232	USB 2.0, LAN/LXI-C, IEEE-488, RS-232	IEEE-488, RS-232	LAN/LXI, IEEE-488, RS-232	LAN/LXI-C, IEEE-488, RS-232	USB 2.0, LAN/LXI, IEEE-488, RS-232	IEEE-488, RS-232
Digital I/O	1 In/4 Out with built-in component handler interfaces (except Model 2401).	1 In/4 Out with built-in component handler interfaces.	1 In/4 Out with built-in component handler interfaces.	1 In/4 Out with built-in component handler interfaces.	1 In/4 Out with built-in component handler interfaces.	14 digital I/O-trigger lines (no digital I/O available for 2604B)	14 digital I/O-trigger lines (no digital I/O available for 2614B)	1 In/4 Out with built-in component handler interfaces (except Model 2401).	14 digital I/O trigger lines	14 digital I/O trigger lines	14 digital I/O-trigger lines (no digital I/O available for 2634B)	1 In/4 Out with built-in component handler interfaces
Other	6½-digit resolution. 6 wire ohms mode. LabView drivers.	6½-digit resolution. 6 wire ohms mode. LabView drivers.	6½-digit resolution. 6 wire ohms mode. LabView drivers.	6½-digit resolution. 6 wire ohms mode. LabView drivers.	6½-digit resolution. 6 wire ohms mode. LabView drivers.	6½-digit resolution. Scalable to 64 channels with TSP-Link Technology (not available for 2604B). Built-in Web-based characterization software. LabView driver.	6½-digit resolution. Scalable to 32 channels with TSP-Link Technology (not available for 2614B.) Built-in Web-based characterization software. LabView driver.	6½-digit resolution. 6 wire ohms mode. LabView drivers.	6½-digit resolution. Scalable to 32 channels with TSP-Link Technology. 6 wire ohms mode. Built-in Web-based characterization software. LabView drivers.	6½-digit resolution. Scalable to 32 channels with TSP-Link Technology. 6 wire ohms mode. Built-in Web-based characterization software. LabView drivers.	6½-digit measurement resolution. Scalable to 64+ channels with TSP-Link Technology (not available for 2634B.) Built-in Web-based characterization software. LabView driver.	6½-digit resolution. 6 wire ohms mode. LabView drivers.
Compliance	CE, UL	CE	CE	CE	CE	CE, UL	CE, UL	CE	CE, UL	CE, ETL	CE, UL	CE

1. In pulse mode.  
 2. Models 2401 and 2400-LV 21V max.  
 3. Ohms measurements on Series 2600 instruments are user-calculated.

SMU INSTRUMENTS

SMU INSTRUMENTS

1.888.KEITHLEY (U.S. only)  
[www.keithley.com](http://www.keithley.com)



A Greater Measure of Confidence

1.888.KEITHLEY (U.S. only)  
[www.keithley.com](http://www.keithley.com)



A Greater Measure of Confidence