



- Источники-измерители серии 2400 обладают широким динамическим диапазоном от 10 пА до 10 А, от 1 мкВ до 1100 В, от 20 Вт до 1000 Вт.
- Работа в четырех квадрантах диаграммы ток-напряжение.
- Основная погрешность 0,012%, разрешение 5,5 разрядов.
- Измерение сопротивлений по четырех- и шестипроводной схеме подключения с программируемыми током и напряжением на зажимах измеряемого устройства.
- 1700 измерений в секунду с разрешением 4,5 разрядов и передачей данных через интерфейс GPIB.
- Встроенный компаратор обеспечивает быстрое тестирование на соответствие.
- В большинстве моделей предусмотрена дополнительная функция автоматической проверки качества контактов.
- Цифровые линии ввода-вывода позволяют проводить быструю сортировку компонентов и подключение к манипуляторам (кроме модели 2401).
- Интерфейсы GPIB, RS-232, триггерные линии.

Принадлежности, входящие в комплект поставки:

измерительные кабели;
программный драйвер LabVIEW (загружаемый с сайта);
программное обеспечение LabTracer (загружаемое с сайта).

Широчайший динамический диапазон по току и напряжению для задач высокоскоростного автоматизированного промышленного тестирования и для лабораторного применения

Источники-измерители серии 2400

Серия 2400 источников-измерителей специально предназначена для задач тестирования, требующих точного взаимодействия источников и измерителей тока и напряжения. Каждая модель данной серии содержит прецизионные высокостабильные маломощные источники постоянного тока и напряжения с обратной связью и маломощный мультиметр разрешением 5,5 разрядов с большим входным сопротивлением, обеспечивающий высокую повторяемость результатов. Источник-измеритель представляет собой компактный одноканальный параметрический тестер по постоянному току. Источники-измерители могут использоваться в качестве источника напряжения, тока, вольтметра, амперметра и омметра. Они обладают целым рядом преимуществ по сравнению с системами, состоящими из отдельных источников и измерительных приборов. Например, благодаря своему компактному размеру всего в половину высоты стойки они позволяют сэкономить ценное место в измерительной стойке или на столе. Кроме того, эти приборы до минимума сокращают время, требующееся для проектирования, сборки, настройки и обслуживания измерительного комплекса, что снижает общую стоимость владения измерительным комплексом. Помимо этого источники-измерители серии 2400 упрощают процедуру измерений, устраняя много сложных проблем синхронизации и подключения, возникающих при использовании нескольких приборов. Все приборы серии 2400 подходят для выполнения широкого спектра измерений в непрерывном режиме, в том числе для измерения сопротивления при заданном токе, напряжения пробоя, тока утечки, сопротивления изоляции и других электрических характеристик.

Измерение тока и напряжения

Все приборы SourceMeter серии 2400 обеспечивают работу в четырех квадрантах диаграммы ток-напряжение. В первом и третьем квадрантах они работают как источники, отдавая мощность в нагрузку. Во втором и четвертом квадрантах они работают как электронная нагрузка, рассеивая внутри себя мощность внешних источников. Напряжение, ток и сопротивление можно измерять как в режиме источника, так и в режиме электронной нагрузки.

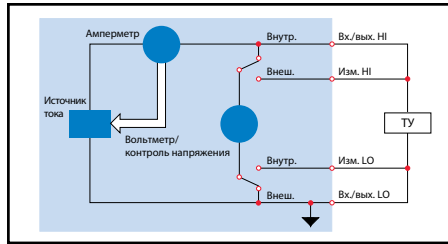

Конфигурация источника тока с измерением напряжения, тока или сопротивления

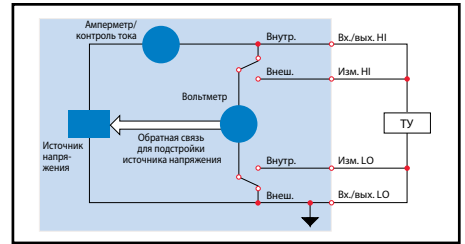

Конфигурация источника напряжения с измерением тока, напряжения или сопротивления

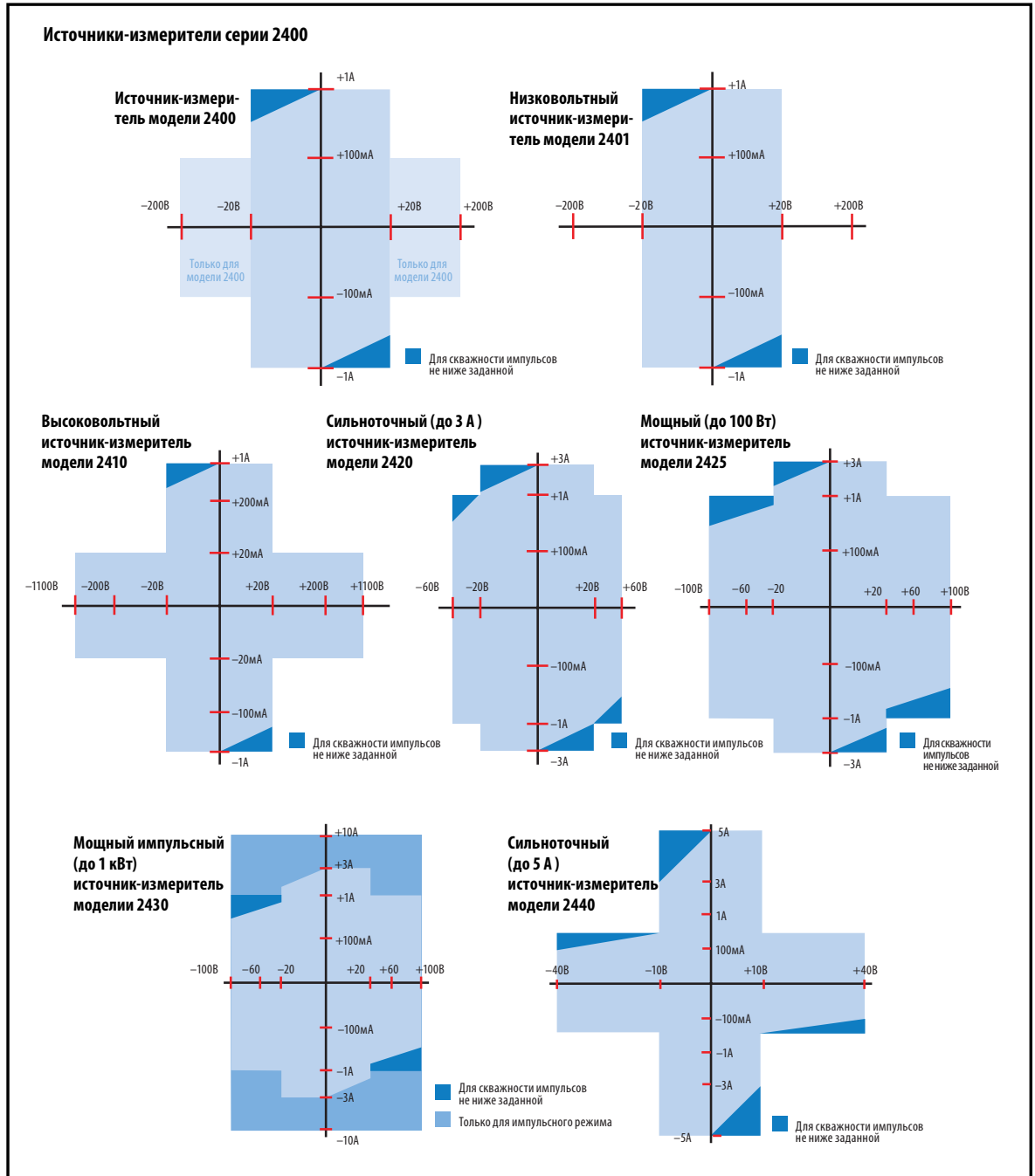

Краткие технические характеристики источников-измерителей серии 2400

Погрешность источника напряжения и вольтметра (в режиме измерения напряжения на нагрузке и контроля напряжения в цепи зондирующего тока)

Модель	Диапазон	Программное разрешение	Погрешность источника (в течение 1 года) 23 °C ± 5 °C ±(% от показаний + вольт)	Разрешение измерительной системы, принятая по умолчанию	Погрешность измерения (в течение 1 года) 23 °C ± 5 °C ±(% от показаний + вольт)	Скорость нарастания выходного напряжения (±30%)	Предельные значения в режимах источника и электронной нагрузки
2400, 2400-C, 2401	200,000 мВ	5 мкВ	0,02% + 600 мкВ	1 мкВ	0,012% + 300 мкВ		± 21 В при токе ±1,05 А ± 210 В при токе ±105 мА*
	2,00000 В	50 мкВ	0,02% + 600 мкВ	10 мкВ	0,012% + 300 мкВ		
	20,0000 В	500 мкВ	0,02% + 2,4 мВ	100 мкВ	0,015% + 1,5 мВ	0,08 В/мкс	
	200,000 В*	5 мВ	0,02% + 24 мВ	1 мВ	0,015% + 10 мВ	0,5 В/мкс	

* Кроме модели 2401.

ДОПОЛНИТЕЛЬНАЯ ТЕМПЕРАТУРНАЯ ПОГРЕШНОСТЬ (0–18 °C и 28–50 °C): ±(0,15 x основная погрешность)/°C.

РЕГУЛИРОВКА НАПЯЖЕНИЯ: на выходных зажимах – 0,01% от диапазона. На нагрузке – 0,01% от диапазона + 100 мкВ.

ЗАЩИТА ОТ ПЕРЕНАПЯЖЕНИЯ: пользовательские значения, допуск 5%. Значение, устанавливаемое по умолчанию отключено.

ОГРАНИЧЕНИЕ ТОКА: ограничение тока в обоих направлениях (при контроле тока) задается одним значением. Мин. значение - 0,1% от диапазона.

АМПЛИТУДА ПЕРЕХОДНОГО ПРОЦЕССА: бросок не более 0,1% (типовое значение при перепаде на всю шкалу источника, активная нагрузка, диапазон 10 мА).

ДОПОЛНИТЕЛЬНЫЕ ТЕХНИЧЕСКИЕ ХАРАКТЕРИСТИКИ (ДЛЯ ВСЕХ МОДЕЛЕЙ СЕРИИ 2400)

ДЛИТЕЛЬНОСТЬ ПЕРЕХОДНЫХ ПРОЦЕССОВ: для возврата выходных параметров к номинальным значениям после ступенчатого изменения нагрузки требуется не менее 30 мкс.

ВРЕМЯ ВЫПОЛНЕНИЯ КОМАНДЫ: максимальное время до начала изменения выходных параметров после получения команды SOURce:VOLTage[CURRent <nrf> при автоматическом выборе диапазона 10 мс, при отключенном автоматическом выборе диапазона 7 мс.

ВРЕМЯ УСТАНОВЛЕНИЯ ВЫХОДНОГО СИГНАЛА: время после обработки команды, необходимое для того, чтобы выходной сигнал достиг значения, отличающегося от конечного не более чем на 0,1%. Типовое значение 100 мкс (для активной нагрузки и диапазона тока от 10 мкА до 100 мА).

СМЕЩЕНИЕ АНАЛОГОВОЙ ЗЕМЛИ ОТНОСИТЕЛЬНО ПОТЕНЦИАЛА КОРПУСА: до ±250 В (±40 В для модели 2440).

ПАДЕНИЕ НАПЯЖЕНИЯ НА ЛИНИЯХ ВОЛЬТМЕТРА (SENSE): не более 1 В на каждой линии

ПОГРЕШНОСТЬ КОНТРОЛЯ НАПЯЖЕНИЯ И ТОКА: к значению основной погрешности следует добавить 0,3% от диапазона и ±0,02% от показаний.

ЗАЩИТА ОТ ПЕРЕГРЕВА: в случае перегрева, обнаруживаемого внутренним датчиком, источник-измеритель переходит в режим ожидания.

БРОСОК ПРИ СМЕНЕ ДИАПАЗОНА: тип. 100 мВ (для соседних диапазонов, при полностью активной нагрузке 100 кОм, в полосе частот от 10 Гц до 1 МГц), кроме диапазонов 20 В/200 В (20 В/60 В для модели 2420) и 20 В/100 В для моделей 2425 и 2430, граничного диапазона и модели 2440.

МИНИМАЛЬНОЕ ИЗМЕРЯЕМОЕ ЗНАЧЕНИЕ ПРИ КОНТРОЛЕ ТОКА И НАПЯЖЕНИЯ: 0,1% от диапазона.

Погрешность по току источника тока и амперметра (в режиме измерения тока нагрузки и контроля тока в цепи источника напряжения)

Модель	Диапазон	Программное разрешение	Погрешность источника (в течение 1 года) 23 °C ± 5 °C ± (% показаний + ампер)	Разрешение при измерении (по умолчанию)	Погрешность измерения (в течение 1 года) 23 °C ± 5 °C ± (% показаний + ампер)	Предельные значения в режимах источника и электронной нагрузки
2400, 2400-C, 2401	1,00000 мкА	50 пА	0,035% + 600 пА	10 пА	0,029% + 300 пА	±1,05 А при ±21 В ±105 мА при ±210 В
	10,0000 мкА	500 пА	0,033% + 2 нА	100 пА	0,027% + 700 пА	
	100,000 мкА	5 нА	0,031% + 20 нА	1 нА	0,025% + 6 нА	
	1,00000 mA	50 нА	0,034% + 200 нА	10 нА	0,027% + 60 нА	
	10,0000 mA	500 нА	0,045% + 2 мкА	100 нА	0,035% + 600 нА	
	100,000 mA	5 мкА	0,066% + 20 мкА	1 мкА	0,055% + 6 мкА	
1,00000 A	50 мкА	0,27% + 900 мкА	10 мкА	0,22% + 570 мкА		

ДОПОЛНИТЕЛЬНАЯ ТЕМПЕРАТУРНАЯ ПОГРЕШНОСТЬ (0–18 °C и 28–50 °C): ±(0,15 x номинальная погрешность)/°C

РЕГУЛИРОВКА ТОКА: в цепи зондирующего тока – 0,01% от диапазона. В нагрузке – 0,01% от диапазона (для диапазона 5 А модели 2440 – 0,05%) + 100 пА.

ОГРАНИЧЕНИЕ НАПЯЖЕНИЯ: пороговое значение для обеих полярностей задается одним значением. Мин. значение 0,1% от диапазона.

АМПЛИТУДА ПЕРЕХОДНОГО ПРОЦЕССА: бросок не более < 0,1%, типовое значение при шаге 1 мА, сопротивлении нагрузки 10 кОм, диапазоне 20 В для моделей 2400, 2401, 2410, 2420, 2425, 2430 (10 В для модели 2440).

ТЕХНИЧЕСКИЕ ХАРАКТЕРИСТИКИ СИСТЕМЫ ПРОВЕРКИ КАЧЕСТВА КОНТАКТОВ (ТОЛЬКО ДЛЯ МОДЕЛЕЙ С ЛИТЕРОЙ «С»)

Кроме модели 2401

СКОРОСТЬ: время проверки и уведомления 350 мкс

ПРОВЕРКА КОНТАКТОВ:	2 Ом	15 Ом	50 Ом
Есть контакт	< 1,00 Ом	< 13,5 Ом	< 47,5 Ом
Нет контакта	> 3,00 Ом	> 16,5 Ом	> 52,5 Ом

Погрешность измерения сопротивления для четырехпроводной и двухпроводной схемы (без учета влияния сопротивления проводов)

Диапазон	Разрешение по умолчанию	Измерительный ток по умолчанию 2400, 2401, 2410	Погрешность в обычном режиме (23 °C ± 5 °C) 1 год, ±(% показаний + ом)	Погрешность в режиме повышенной точности (23 °C ± 5 °C) 1 год, ±(% показаний + ом)	ДОПОЛНИТЕЛЬНАЯ ТЕМПЕРАТУРНАЯ ПОГРЕШНОСТЬ (0–18 °C и 28–50 °C): ± 0,15 x основная погрешность)/°C.
< 0,20000 Ом	–	–	(погрешность источника тока) + (погрешность вольтметра)	(погрешность источника тока) + (погрешность вольтметра)	РЕЖИМ ИСТОЧНИКА ТОКА И ИЗМЕРЕНИЯ СОПРОТИВЛЕНИЯ В РУЧНОМ РЕЖИМЕ: общая погрешность = погрешность источника тока + погрешность измерения напряжения (четырёхпроводная схема подключения). РЕЖИМ ИСТОЧНИКА НАПЯЖЕНИЯ И ИЗМЕРЕНИЯ СОПРОТИВЛЕНИЯ В РУЧНОМ РЕЖИМЕ: общая погрешность = погрешность источника напряжения + погрешность измерения тока (четырёхпроводная схема подключения). ШЕСТИПРОВОДНАЯ СХЕМА ПОДКЛЮЧЕНИЯ: измерения сопротивлений могут выполняться с использованием активной компенсации токов утечки при помощи эквипотенциального охранного электрода (Guard) и охранного измерительного электрода (Guard Sense). Макс. выходной ток активной компенсации охранного электрода - 50 мА (кроме диапазона 1 А). Погрешность зависит от нагрузки. Формулу для расчета см. в техническом документе № 2033. ВЫХОДНОЕ СОПРОТИВЛЕНИЕ ОХРАННОГО ЭЛЕКТРОДА (Guard): < 0,1 Ом в режиме измерения сопротивлений.
2,00000 Ом	10 мкОм	–	(погрешность источника тока) + (погрешность вольтметра)	(погрешность источника тока) + (погрешность вольтметра)	
20,0000 Ом	100 мкОм	100 мА	0,10% + 0,003 Ом	0,07% + 0,001 Ом	
200,000 Ом	1 мОм	10 мА	0,08% + 0,03 Ом	0,05% + 0,01 Ом	
2,00000 кОм	10 мОм	1 мА	0,07% + 0,3 Ом	0,05% + 0,1 Ом	
20,0000 кОм	100 мОм	100 мкА	0,06% + 3 Ом	0,04% + 1 Ом	
200,000 кОм	1 Ом	10 мкА	0,07% + 30 Ом	0,05% + 10 Ом	
2,00000 МОм	10 Ом	1 мкА	0,11% + 300 Ом	0,05% + 100 Ом	
20,0000 МОм	100 Ом	1 мкА	0,11% + 1 кОм	0,05% + 500 Ом	
200,000 МОм	1 кОм	100 нА	0,66% + 10 кОм	0,35% + 5 кОм	
> 200,000 МОм	–	–	(погрешность источника тока) + (погрешность вольтметра)	(погрешность источника тока) + (погрешность вольтметра)	

Краткие технические характеристики источников-измерителей серии 2400 (продолжение)

Быстродействие

РЕЖИМ ИЗМЕРЕНИЯ¹

МАКСИМАЛЬНАЯ СКОРОСТЬ ПЕРЕКЛЮЧЕНИЯ ДИАПАЗОНОВ: 75/сек.

МАКСИМАЛЬНОЕ ВРЕМЯ ИЗМЕРЕНИЯ В РЕЖИМЕ АВТОМАТИЧЕСКОГО ВЫБОРА ДИАПАЗОНА: 40 мс (при постоянных параметрах источника)².

Скорость измерений (отсчетов в секунду) в режиме развертки³ для частоты 60 Гц (50 Гц).

Скорость	NPLC*/тип сигнала запуска	Режим измерения		Режим источника-измерителя (установка напряжения или тока источника с измерением)		Тестирование на соответствие ^{4,5} в режиме источника-измерителя ⁵		Режим источника ⁴	
		Запись в память	Передача по GPIB	Запись в память	Передача по GPIB	Запись в память	Передача по GPIB	Запись в память	Передача по GPIB
Высокая Режим IEEE-488.1	0,01/внутренний	2081 (2030)	1754	1551 (1515)	1369	902 (900)	981	165 (162)	165
	0,01/внешний	1239 (1200)	1254	1018 (990)	1035	830 (830)	886	163 (160)	163
Высокая Режим IEEE-488.2	0,01/внутренний	2081 (2030)	1198 (1210)	1551 (1515)	1000 (900)	902 (900)	809 (840)	165 (162)	164 (162)
	0,01/внешний	1239 (1200)	1079 (1050)	1018 (990)	916 (835)	830 (830)	756 (780)	163 (160)	162 (160)
Средняя Режим IEEE-488.2	0,10/внутренний	510 (433)	509 (433)	470 (405)	470 (410)	389 (343)	388 (343)	133 (126)	132 (126)
	0,10/внешний	438 (380)	438 (380)	409 (360)	409 (365)	374 (333)	374 (333)	131 (125)	131 (125)
Стандартная Режим IEEE-488.2	1,00/внутренний	59 (49)	59 (49)	58 (48)	58 (48)	56 (47)	56 (47)	44 (38)	44 (38)
	1,00/внешний	57 (48)	57 (48)	57 (48)	57 (47)	56 (47)	56 (47)	44 (38)	44 (38)

* - NPLC – период напряжения промышленной сети (20 мс для 50 Гц). Например. Значению NPLC=0,01 соответствует время усреднения 200 мкс.

Скорость измерений (отсчетов в секунду) в режиме единичных отсчетов для частоты 60 Гц (50 Гц).

Скорость	NPLC/тип сигнала запуска	Режим измерения с передачей по GPIB	Режим источника-измерителя ⁵ с передачей по GPIB	Тестирование на соответствие ^{4,5} в режиме источника-измерителя ⁵ с передачей по GPIB
Высокая (488.1)	0,01/внутренний	537	140	135
Высокая (488.2)	0,01/внутренний	256 (256)	79 (83)	79 (83)
Средняя (488.2)	0,10/внутренний	167 (166)	72 (70)	69 (70)
Стандартная (488.2)	1,00/внутренний	49 (42)	34 (31)	35 (30)

Время измерений на частоте 60 Гц (50 Гц):^{4,6}

Скорость	NPLC/тип сигнала запуска	Режим измерения с передачей по GPIB	Тестирование на соответствие в режиме источника	Тестирование на соответствие ^{5,7} в режиме источника-измерителя с передачей по GPIB
Высокая	0,01/внешний	1,04 мс (1,08 мс)	0,5 мс (0,5 мс)	4,82 мс (5,3 мс)
Средняя	0,10/внешний	2,55 мс (2,9 мс)	0,5 мс (0,5 мс)	6,27 мс (7,1 мс)
Стандартная	1,00/внешний	17,53 мс (20,9 мс)	0,5 мс (0,5 мс)	21,31 мс (25,0 мс)

¹ Скорости снятия показаний применимы к измерениям напряжения или тока. Автоматическое обнуление выкл., автоматический выбор диапазона выкл., фильтр выкл., отображение выкл., задержка запуска = 0, двоичный формат передачи.

² Соединительные провода имеют только активное сопротивление. В диапазонах 1 мкА и 10 мкА < 65 мс.

³ Приведены параметры для развертки 1000 точек с источником, работающим в фиксированном диапазоне.

⁴ Тестирование на соответствие выполняется с использованием одного верхнего предела и одного нижнего предела.

⁵ Включая время на перепрограммирование источника на новый уровень перед проведением измерений.

⁶ Время от заднего фронта сигнала «НАЧАЛО ТЕСТИРОВАНИЯ» до заднего фронта сигнала «КОНЕЦ ТЕСТИРОВАНИЯ»

⁷ Время обработки команды SOURCE:VOLTage[CURRENT:TRIGgered <nrg> не учитывается.

ОБЩИЕ ХАРАКТЕРИСТИКИ

Подавление шумов

Скорость	NPLC	NMRR	CMRR
Высокая	0,01	–	80 дБ
Средняя	0,1	–	80 дБ
Стандартная	1	60 дБ	100 дБ ¹

1. Кроме двух нижних диапазонов тока, для которых 90 дБ.

СОПРОТИВЛЕНИЕ НАГРУЗКИ: стабильность сохраняется до тип. зн. 20 000 пФ.

МАКСИМАЛЬНОЕ НАПРЯЖЕНИЕ СИНОФАЗНОГО СИГНАЛА: 250 В (40 в пост. для модели 2440)

СОПРОТИВЛЕНИЕ ИЗОЛЯЦИИ В РЕЖИМЕ СИНОФАЗНОГО СИГНАЛА: > 10⁹ Ом, < 1000 пФ.

ВЫХОД ЗА ПРЕДЕЛЫ ДИАПАЗОНА: 105% от диапазона для источника и измерителя.

МАКС. ПАДЕНИЕ НАПРЯЖЕНИЯ МЕЖДУ КЛЕММАМИ ИСТОЧНИКА И ИЗМЕРИТЕЛЯ Input/Output HI – Sense HI, Input/Output LO – Sense LO: 5 В

МАКС. СОПРОТИВЛЕНИЕ СОЕДИНИТЕЛЬНЫХ ЛИНИЙ Sense LO, Sense HI: 1 МОм для обеспечения номинальной погрешности.

СОПРОТИВЛЕНИЕ ИЗМЕРИТЕЛЬНОГО ВХОДА: > 10¹⁰ Ом

НАПРЯЖЕНИЕ СМЕЩЕНИЯ ОХРАННОГО ЭЛЕКТРОДА: тип. зн. < 150 мкВ (300 мкВ для моделей 2430, 2440).

ВХОДНЫЕ РЕЖИМЫ ИСТОЧНИКА: импульсный (только для модели 2430), с фиксированным постоянным уровнем, последовательность постоянных уровней из внутренней памяти (комбинированная функциональность), ступенчатая развертка (линейная и логарифмическая).

БУФЕР ПАМЯТИ: 5000 пятизначных отсчетов (два буфера по 2500 точек). Включает выбранные измеренные значения и временную метку. Резервное питание от литиевой батареи (срок службы батареи не менее 3 лет).

ВНУТРЕННЯЯ ПАМЯТЬ ИСТОЧНИКА: не более 100 значений.

ВОЗМОЖНОСТЬ ПРОГРАММИРОВАНИЯ: IEEE-488 (SCPI-1995.0), RS-232, 5 пользовательских конфигураций, заводская конфигурация по умолчанию и сброс (команда *RST).

ЦИФРОВОЙ ИНТЕРФЕЙС

Блокировка: активный вход низкого уровня.

Интерфейс манипулятора: запуск тестирования, завершение тестирования, 3 бита категории. Питание +5 В, 300 мА.

Цифровые входы и выходы: 1 вход запуска, 4 выхода TTL или выхода управления (33 В, 500 мА, диодная фиксация уровня).

ЭЛЕКТРОПИТАНИЕ: от 100 до 240 В / 50–60 Гц (автоматическое определение при включении). Модели 2400, 2401: 190 ВА. Модель 2410: 210 ВА. Модель 2420: 220 ВА. Модели 2425, 2430: 250 ВА. Модель 2440: 240 ВА.

ЭЛЕКТРОМАГНИТНАЯ СОВМЕСТИМОСТЬ: в соответствии с Директивой Европейского союза 89/336/EEC, EN 61326-1.

БЕЗОПАСНОСТЬ: аттестовано UL согласно UL 61010B-1:2003. Соответствует Директиве Европейского союза по низковольтному оборудованию.

УСТОЙЧИВОСТЬ К ВИБРАЦИИ: MIL-PRF-28800F класс 3, произвольная.

ВРЕМЯ ПРОГРЕВА: в течение одного часа для обеспечения номинальных погрешностей.

РАЗМЕРЫ: (высота x ширина x глубина) 89 x 213 x 370 мм (3-1/2 x 8-3/8 x 14-9/16 дюйм). Настольная модификация (с ручкой и ножками): (высота x ширина x глубина) 104 x 238 x 370 мм (4-1/8 x 9-3/8 x 14-9/16 дюйм).

МАССА: 3,21 кг (7,08 фунт) (модели 2425, 2430, 2440: 4,1 кг, 9,0 фунт).

УСЛОВИЯ ЭКСПЛУАТАЦИИ И ХРАНЕНИЯ: рабочий диапазон температур: 0–50 °С, отн. влажность 70% при 35 °С. В диапазоне температур 35–50 °С допустимая отн. влажность снижается на 3% на градус.

Диапазон температур хранения: от –25 °С до +65 °С.

Series 2400

SourceMeter® SMU Instruments



Keithley's Series 2400 Source Measure Unit (SMU) Instruments are designed specifically for test applications that demand tightly coupled sourcing and measurement. All SourceMeter models provide precision voltage and current sourcing as well as measurement capabilities. Each SourceMeter SMU instrument is both a highly stable DC power source and a true instrument-grade 6½-digit multimeter. The power source characteristics include low noise, precision, and readback. The multimeter capabilities include high repeatability and low noise. The result is a compact, single-channel, DC parametric tester. In operation, these instruments can act as a voltage source, a current source, a voltage meter, a current meter, and an ohmmeter. Manufacturers of components and modules for the communications, semiconductor, computer, automotive, and medical industries will find the SourceMeter SMU instruments invaluable for a wide range of characterization and production test applications.

Advantages of a Tightly Integrated Instrument

By linking source and measurement circuitry in a single unit, these instruments offer a variety of advantages over systems configured with separate source and measurement instruments. For example, they minimize the time required for test station development, setup, and maintenance, while lowering the overall cost of system ownership. They simplify the test process itself

by eliminating many of the complex synchronization and connection issues associated with using multiple instruments. And, their compact half-rack size conserves precious "real estate" in the test rack or bench.

Power of Five Instruments in One (IV Source, IVR Measure)

The tightly coupled nature of a SourceMeter SMU instrument provides many advantages over solutions configured from separate instruments, such as a precision power supply and a digital multimeter. For example, it provides faster test times by reducing GPIB traffic and simplifies the remote programming interface. It also protects the device under test from damage due to accidental overloads, thermal runaway, etc. Both the current and voltage source are programmable with readback to help maximize device measurement integrity. If the readback reaches a programmed compliance limit, then the source is clamped at the limit, providing fault protection.

ACCESSORIES AVAILABLE

TEST LEADS AND PROBES

1754	2-Wire Universal 10-Piece Test Lead Kit
5804	Kelvin (4-Wire) Universal 10-Piece Test Lead Kit
5805	Kelvin (4-Wire) Spring-Loaded Probes
5808	Low Cost Single-pin Kelvin Probe Set
5809	Low Cost Kelvin Clip Lead Set
8607	2-Wire, 1000V Banana Cables, 1m (3.3 ft)
CA-18-1	Shielded Dual Banana Cable, 1.2m (4 ft)

SWITCHING HARDWARE

7001	Two-Slot Switch System
7002	Ten-Slot Switch System
7019-C	6-Wire Ohms Switch Card
7053	High-Current Switch Card

CABLES/ADAPTERS

7007-1	Shielded GPIB Cable, 1m (3.3 ft)
7007-2	Shielded GPIB Cable, 2m (6.6 ft)
7009-5	RS-232 Cable
8620	Shorting Plug

COMMUNICATION INTERFACE

KPCI-488LPA	IEEE-488 Interface/Controller for the PCI Bus
KUSB-488B	IEEE-488 USB-to-GPIB Interface Adapter

TRIGGERING AND CONTROL

2499-DIGIO	Digital I/O Expander Assembly (not for Model 2401)
8501-1	Trigger Link Cable, DIN-to-DIN, 1m (3.3 ft)
8501-2	Trigger Link Cable, DIN-to-DIN, 2m (6.6 ft)
8502	Trigger Link to BNC Breakout Box
8503	Trigger Link Cable, DIN-to-Dual BNC, 1m (3.3 ft)
8505	Male to 2-Female Y-DIN Cable for Trigger Link

RACK MOUNT KITS

4288-1	Single Fixed Rack Mount Kit
4288-2	Dual Fixed Rack Mount Kit
4288-4	Dual Fixed Rack Mount Kit
4288-5	Shelf Type Side by Side Rack Mounting Kit
4288-9	Dual Fixed Rack Mounting Kit

SOFTWARE

LabTracer 2.0	Curve Tracing Software (downloadable)
---------------	---------------------------------------

- Five instruments in one (IV Source, IVR Measure)
- Seven models: 20–100W DC, 1000W pulsed, 1100V to 1µV, 10A to 10pA
- Source and sink (4-quadrant) operation
- 0.012% basic measure accuracy with 6½-digit resolution
- 2-, 4-, and 6-wire remote V-source and measure sensing
- 1700 readings/second at 4½ digits via GPIB
- Pass/Fail comparator for fast sorting/binning
- Available high speed sense lead contact check function
- Programmable DIO port for automation/handler/prober control (except Model 2401)
- Standard SCPI GPIB, RS-232 and Keithley Trigger Link interfaces
- Keithley LabTracer 2.0 I-V curve tracing application software (download)

Tightly coupled precision sourcing and measurement

SMU INSTRUMENTS

1.888.KEITHLEY (U.S. only)

www.keithley.com

KEITHLEY

A Greater Measure of Confidence

A Tektronix Company

Series 2400

SourceMeter[®] SMU Instruments

Ordering Information

- 2400** 200V, 1A, 20W SourceMeter SMU Instrument
- 2400-C** 200V, 1A, 20W SourceMeter SMU Instrument with Contact Check
- 2401** 20V, 1A, 20W SourceMeter SMU Instrument
- 2410** 1100V, 1A, 20W SourceMeter SMU Instrument
- 2410-C** 1100V, 1A, 20W SourceMeter SMU Instrument with Contact Check
- 2420** 60V, 3A, 60W SourceMeter SMU Instrument
- 2420-C** 60V, 3A, 60W SourceMeter SMU Instrument with Contact Check
- 2425** 100V, 3A, 100W SourceMeter SMU Instrument
- 2425-C** 100V, 3A, 100W SourceMeter SMU Instrument with Contact Check
- 2430** 100V, 10A, 1000W Pulse Mode SourceMeter SMU Instrument
- 2430-C** 100V, 10A, 1000W Pulse Mode SourceMeter SMU Instrument with Contact Check
- 2440** 40V, 5A, 50W SourceMeter SMU Instrument
- 2440-C** 40V, 5A, 50W SourceMeter SMU Instrument with Contact Check

Accessories Supplied

- Model 8605 Test Leads
- LabVIEW Software Driver (downloadable)
- LabTracer Software (downloadable)

I-V Characteristics

All SourceMeter SMU instruments provide four-quadrant operation. In the first and third quadrants they operate as a source, delivering power to a load. In the second and fourth quadrants they operate as a sink, dissipating power internally. Voltage, current, and resistance can be measured during source or sink operation.

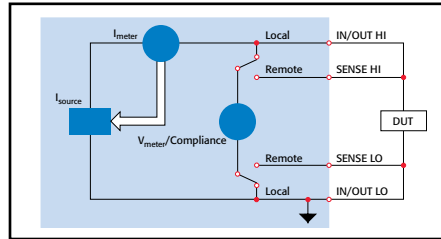

Source I-Measure V, I, or Ω configuration

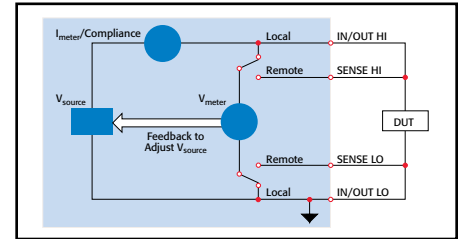

Source V-Measure I, V, or Ω configuration

Series 2400 SourceMeter SMU Instruments

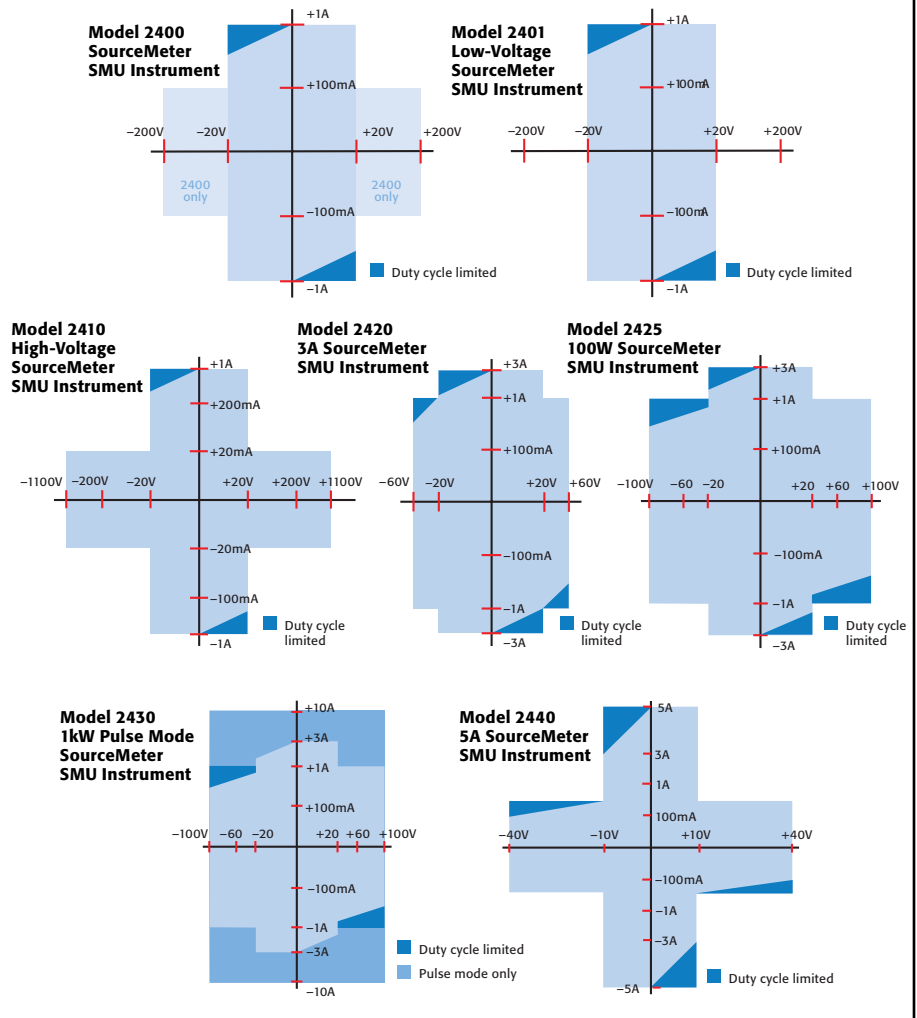

1.888.KEITHLEY (U.S. only)

www.keithley.com

A Greater Measure of Confidence

KEITHLEY

A Tektronix Company

Tightly coupled precision sourcing and measurement

SMU INSTRUMENTS

Series 2400

SourceMeter[®] SMU Instruments

Automation for Speed

A SourceMeter SMU instrument streamlines production testing. It sources voltage or current while making measurements without needing to change connections. It is designed for reliable operation in non-stop production environments. To provide the throughput demanded by production applications, the SourceMeter SMU instrument offers many built-in features that allow it to run complex test sequences without computer control or GPIB communications slowing things down.

Standard and Custom Sweeps

Sweep solutions greatly accelerate testing with automation hooks. Three basic sweep waveforms are provided that can be programmed for single-event or continuous operation. They are ideal for I/V, I/R, V/I, and V/R characterization.

- Linear Staircase Sweep: Moves from the start level to the stop level in equal linear steps
- Logarithmic Staircase Sweep: Done on a log scale with a specified number of steps per decade
- Custom Sweep: Allows construction of special sweeps by specifying the number of measurement points and the source level at each point
- Up to 1700 readings/second at 4½ digits to the GPIB bus
- 5000 readings can be stored in the non-volatile buffer memory

Built-In Test Sequencer (Source Memory List)

The Source Memory list provides faster and easier testing by allowing you to setup and execute up to 100 different tests that run without PC intervention.

- Stores up to 100 instrument configurations, each containing source settings, measurement settings, pass/fail criteria, etc.
- Pass/fail limit test as fast as 500µs per point
- Onboard comparator eliminates the delay caused when sending data to the computer for analysis
- Built-in, user definable math functions to calculate derived parameters

Example Test Sequence

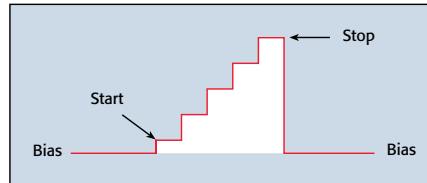
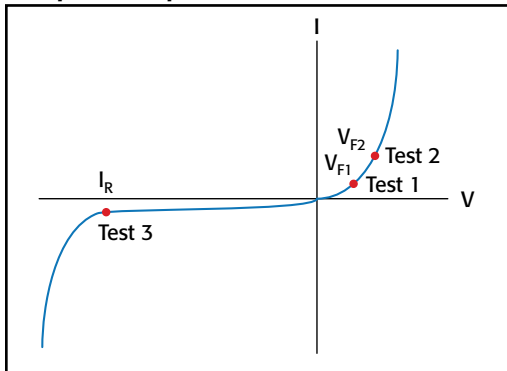

Linear staircase sweep

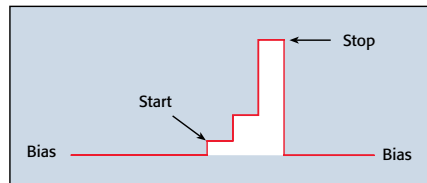

Logarithmic staircase sweep

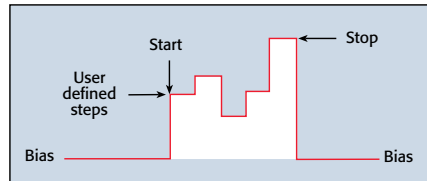

Custom sweep

TYPICAL APPLICATIONS

Devices:

- Discrete semiconductor devices
- Passive devices
- Transient suppression devices
- ICs, RFICs, MMICs
- Laser diodes, laser diode modules, LEDs, photodetectors
- Circuit protection devices: TVS, MOV, Fuses, etc.
- Airbags
- Connectors, switches, relays
- High brightness LEDs (DC and pulse)

Tests:

- Leakage
- Low voltage/resistances
- LIV
- IDDQ
- I-V characterization
- Isolation and trace resistance
- Temperature coefficient
- Forward voltage, reverse breakdown, leakage current
- DC parametric test
- DC power source
- HIPOT
- Photovoltaic cell efficiency (source and sink)
- Dielectric withstanding

Test	Pass/Fail Test	If Passes Test	If Fails Test
Test 1	Check V_{F1} at 100mA against pass/fail limits	Go to Test 2	1. Bin part to bad bin 2. Transmit data to computer while handler is placing new part 3. Return to Test 1
Test 2	Check V_{F2} at 1A against pass/fail limits	Go to Test 3	
Test 3	Check leakage current at -500V and test against pass/fail limits	1. Bin part to good bin 2. Transmit readings to computer while handler is placing new part 3. Return to Test 1	

1.888.KEITHLEY (U.S. only)

www.keithley.com

Series 2400

SourceMeter[®] SMU Instruments

Digital I/O Interface

The digital I/O interface can link a SourceMeter SMU instrument to many popular component handlers, including Aetrium, Aeco, and Robotronics. Other capabilities of the interface include:

- Tight systems integration for applications such as binning and sorting
- Built-in component handler interface
- Start of test and end of test signals
- 5V, 300mA power supply
- Optional expander accessory (Model 2499-DIGIO) adds 16 digital I/O lines

The digital I/O interface is available on all Series 2400 SourceMeter instruments except the Model 2401.

Trigger Link Interface

All SourceMeter SMU instruments include Keithley's unique Trigger Link interface which provides high-speed, seamless communications with many of Keithley's other instruments. For example, use the Trigger Link interface to connect a SourceMeter SMU instrument with a Series 7000 Switching System for a complete multi-point test solution. With Trigger Link, the Series 7000 Switching Systems can be controlled by a SourceMeter SMU instrument during a high-speed test sequence independent of a computer and GPIB.

Optional Contact Check Function

The Contact Check function makes it simple to verify good connections quickly and easily before an automated test sequence begins. This eliminates measurement errors and false product failures associated with contact fatigue, breakage, contamination, loose or broken connection, relay failures, etc. Some capabilities of this function are:

- 350 μ s verification and notification process time
- The output of the SourceMeter SMU instrument is automatically shut off after a fault and is not re-activated until good contact is verified, protecting the device under test from damage and the operator from potential safety hazards.
- 3 pass/fail threshold values: 2 Ω , 15 Ω , and 50 Ω
- No energy passes through the device under test during the operation.
- Enabled either from the front panel or remotely over the GPIB
- 3 fault notification methods

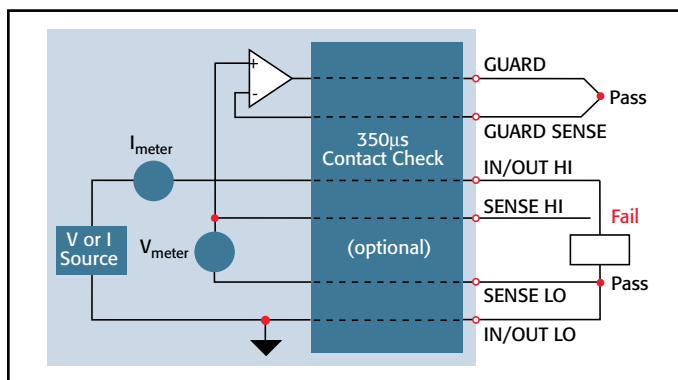

Contact check option for 4-wire or 6-wire applications

Unique 6-Wire Ohms Technique

SourceMeter SMU instruments can make standard 4-wire, split Kelvin, and 6-wire, guarded ohms measurements and can be configured for either the constant current or constant voltage method. The 6-wire ohms technique:

- Uses guard and guard sense leads in addition to the 4-wire sense and source leads.
- Locks out parallel current paths when measuring resistor networks or hybrid circuits to isolate the component under test.
- Allows users to configure and plot data easily from Series 2400 SourceMeter SMU instruments, making characterization of two, three, and four terminal devices a snap.

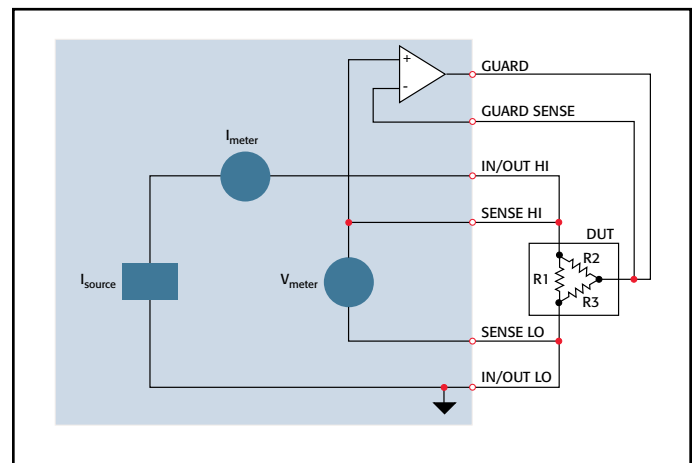

6-Wire Ohms Circuit. All test current flows through R1 because the high current guard drives the voltage across R2 to 0V.

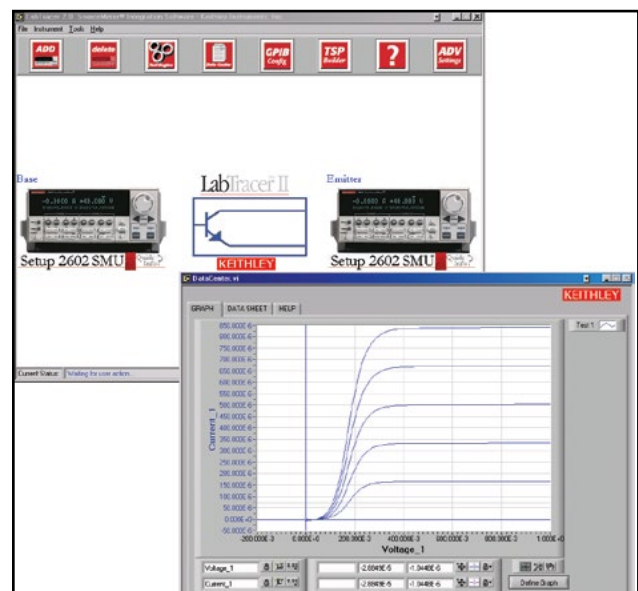

Free LabTracer 2.0 device characterization software (downloadable)

1.888.KEITHLEY (U.S. only)

www.keithley.com

KEITHLEY

A Greater Measure of Confidence

A Tektronix Company

Tightly coupled precision sourcing and measurement

SMU INSTRUMENTS

Voltage Accuracy (Local or Remote Sense)

Model	Range	Programming Resolution	Source ¹ Accuracy (1 Year) 23°C ±5°C ±(% rdg. + volts)	Default Measurement Resolution	Measurement ^{2,3,4} Accuracy (1 Year) 23°C ±5°C ±(% rdg. + volts)	Output Slew Rate (±30%)	Source/Sink Limit
2400, 2400-C, 2401	200.000 mV	5 μV	0.02% + 600 μV	1 μV	0.012% + 300 μV		
	2.00000 V	50 μV	0.02% + 600 μV	10 μV	0.012% + 300 μV		±21 V @ ±1.05 A
	20.0000 V	500 μV	0.02% + 2.4 mV	100 μV	0.015% + 1.5 mV	0.08 V/μs	±210 V @ ±105 mA*
	200.000 V*	5 mV	0.02% + 24 mV	1 mV	0.015% + 10 mV	0.5 V/μs	
2410, 2410-C	200.000 mV	5 μV	0.02% + 600 μV	1 μV	0.012% + 300 μV		
	2.00000 V	50 μV	0.02% + 600 μV	10 μV	0.012% + 300 μV		±21 V @ ±1.05 A
	20.0000 V	500 μV	0.02% + 2.4 mV	100 μV	0.015% + 1 mV	0.15 V/μs	±1100 V @ ±21 mA
	1000.00 V	50 mV	0.02% + 100 mV	10 mV	0.015% + 50 mV	0.5 V/μs	
2420, 2420-C	200.000 mV	5 μV	0.02% + 600 μV	1 μV	0.012% + 300 μV		
	2.00000 V	50 μV	0.02% + 600 μV	10 μV	0.012% + 300 μV		±21 V @ ±3.15 A
	20.0000 V	500 μV	0.02% + 2.4 mV	100 μV	0.015% + 1 mV	0.08 V/μs	±63 V @ ±1.05 A
	60.0000 V	1.5 mV	0.02% + 7.2 mV	1 mV	0.015% + 3 mV	0.14 V/μs	
2425, 2425-C	200.000 mV	5 μV	0.02% + 600 μV	1 μV	0.012% + 300 μV		
	2.00000 V	50 μV	0.02% + 600 μV	10 μV	0.012% + 300 μV		±21 V @ ±3.15 A
	20.0000 V	500 μV	0.02% + 2.4 mV	100 μV	0.015% + 1 mV	0.08 V/μs	±105 V @ ±1.05 A
	100.0000 V	2.5 mV	0.02% + 12 mV	1 mV	0.015% + 5 mV	0.25 V/μs	
2430, 2430-C	200.000 mV	5 μV	0.02% + 600 μV	1 μV	0.012% + 300 μV		±105 V @ ±1.05 A
	2.00000 V	50 μV	0.02% + 600 μV	10 μV	0.012% + 300 μV		
	20.0000 V	500 μV	0.02% + 2.4 mV	100 μV	0.015% + 1 mV	0.08 V/μs	±105 V @ ±10.5 A
	100.0000 V	2.5 mV	0.02% + 12 mV	1 mV	0.015% + 5 mV	0.25 V/μs	(pulse mode only)
2440, 2440-C	200.000 mV	5 μV	0.02% + 600 μV	1 μV	0.012% + 300 μV		
	2.00000 V	50 μV	0.02% + 600 μV	10 μV	0.012% + 300 μV		±10.5 V @ ±5.25 A
	10.0000 V	500 μV	0.02% + 1.2 mV	100 μV	0.015% + 750 μV	0.08 V/μs	±42 V @ ±1.05 A
	40.0000 V	5 mV	0.02% + 4.8 mV	1 mV	0.015% + 3 mV	0.25 V/μs	

*Not available on Model 2401.

TEMPERATURE COEFFICIENT (0°–18°C and 28°–50°C): ±(0.15 × accuracy specification)/°C.

VOLTAGE REGULATION: Line: 0.01% of range. Load: 0.01% of range + 100μV.

OVER VOLTAGE PROTECTION: User selectable values, 5% tolerance. Factory default = none.

CURRENT LIMIT: Bipolar current limit (compliance) set with single value. Min. 0.1% of range.

OVERSHOOT: <0.1% typical (full scale step, resistive load, 10mA range).

ADDITIONAL SOURCE SPECIFICATIONS (All Models)

TRANSIENT RESPONSE TIME: 30μs minimum for the output to recover to its spec. following a step change in load.

COMMAND PROCESSING TIME: Maximum time required for the output to begin to change following the receipt of .SOURce:VOLTage|CURRent <nrf> command. **Autorange On:** 10ms. **Autorange Off:** 7ms.

OUTPUT SETTLING TIME: Time required to reach 0.1% of final value after command is processed. 100μs typical. Resistive load. 10μA to 100mA range.

DC FLOATING VOLTAGE: Output can be floated up to ±250VDC (Model 2440 ±40VDC) from chassis ground.

REMOTE SENSE: Up to 1V drop per load lead.

COMPLIANCE ACCURACY: Add 0.3% of range and ±0.02% of reading to base specification.

OVER TEMPERATURE PROTECTION: Internally sensed temperature overload puts unit in standby mode.

RANGE CHANGE OVERSHOOT: Overshoot into a fully resistive 100kΩ load, 10Hz to 1MHz BW, adjacent ranges: 100mV typical, except 20V/200V (20V/60V on Model 2420), 20V/100V on Model 2425 and 2430, range boundary, and Model 2440.

MINIMUM COMPLIANCE VALUE: 0.1% of range.

ADDITIONAL PULSE MODE SOURCE SPECIFICATIONS (2430 and 2430-C only)

MAXIMUM DUTY CYCLE: 8%, hardware limited, 10A range only. All other ranges 100%.

MAXIMUM PULSE WIDTH: 5ms from 90% rising to 90% falling edge, 2.5ms 10A range.

MINIMUM PULSE WIDTH: 150μs.

MINIMUM PULSE RESOLUTION: 50μs typical, 70μs max., limited by system jitter.

SOURCE ACCURACY: Determined by settling time and source range specifications.

OUTPUT SETTLING TIME 0.1%:

800μs typ., source I = 10A into 10Ω, limited by voltage slew rate.

500μs typ., source I = 10A into 1Ω, limited by voltage slew rate.

OUTPUT SLEW RATE:

Voltage (10Ω load): 0.25V/μs ±30% on 100V range. 0.08V/μs ±30% on 20V range, 10A range.

Current (0Ω load): 0.25A/μs ±30% on 100V range. 0.08A/μs ±30% on 20V range, 10A range.

NOTES

- 2400, 2401, 2410 Only: Specifications valid for continuous output currents below 105mA. For operation above 105mA continuous for >1 minute, derate accuracy 10%/35mA above 105mA.
- Speed = Normal (1 PLC). For 0.1 PLC, add 0.005% of range to offset specifications, except 200mV, 1A, 10A ranges, add 0.05%. For 0.01 PLC, add 0.05% of range to offset specifications, except 200mV, 1A, 10A ranges, add 0.5%.
- Accuracies apply to 2- or 4-wire mode when properly zeroed.
- In pulse mode, limited to 0.1 PLC measurement.

1.888.KEITHLEY (U.S. only)

www.keithley.com

KEITHLEY

A Greater Measure of Confidence

A Tektronix Company

Current Accuracy (Local or Remote Sense)

Model	Range	Programming Resolution	Source ^{1,3} Accuracy (1 Year) 23°C ±5°C ±(% rdg. + amps)	Default Measurement Resolution	Measurement ^{5,6,7} Accuracy (1 Year) 23°C ±5°C ±(% rdg. + amps)	Source/Sink Limit
2400, 2400-C, 2401	1.00000 µA	50 pA	0.035% + 600 pA	10 pA	0.029% + 300 pA	±1.05A @ ±21 V ±105 mA @ ±210 V ⁸
	10.0000 µA	500 pA	0.033% + 2 nA	100 pA	0.027% + 700 pA	
	100.000 µA	5 nA	0.031% + 20 nA	1 nA	0.025% + 6 nA	
	1.00000 mA	50 nA	0.034% + 200 nA	10 nA	0.027% + 60 nA	
	10.0000 mA	500 nA	0.045% + 2 µA	100 nA	0.035% + 600 nA	
	100.000 mA	5 µA	0.066% + 20 µA	1 µA	0.055% + 6 µA	
2410, 2410-C	1.00000 A ²	50 µA	0.27 % + 900 µA	10 µA	0.22 % + 570 µA	±1.05A @ ±21 V ±21 mA @ ±1100 V
	10.0000 µA	50 pA	0.035% + 600 pA	10 pA	0.029% + 300 pA	
	10.0000 µA	500 pA	0.033% + 2 nA	100 pA	0.027% + 700 pA	
	100.000 µA	5 nA	0.031% + 20 nA	1 nA	0.025% + 6 nA	
	1.00000 mA	50 nA	0.034% + 200 nA	10 nA	0.027% + 60 nA	
	20.0000 mA	500 nA	0.045% + 4 µA	100 nA	0.035% + 1.2 µA	
2420, 2420-C	100.000 mA	5 µA	0.066% + 20 µA	1 µA	0.055% + 6 µA	±3.15A @ ±21 V ±1.05 A @ ±63 V
	1.00000 A ²	50 µA	0.067% + 900 µA	10 µA	0.066% + 570 µA	
	3.00000 A ²	50 µA	0.059% + 2.7 mA	10 µA	0.052% + 1.71 mA	
	10.0000 µA	500 pA	0.033% + 2 nA	100 pA	0.027% + 700 pA	
	100.000 µA	5 nA	0.031% + 20 nA	1 nA	0.025% + 6 nA	
	1.00000 mA	50 nA	0.034% + 200 nA	10 nA	0.027% + 60 nA	
2425, 2425-C	10.0000 mA	500 nA	0.045% + 2 µA	100 nA	0.035% + 600 nA	±3.15A @ ±21 V ±1.05 A @ ±105 V
	100.000 mA	5 µA	0.066% + 20 µA	1 µA	0.055% + 6 µA	
	1.00000 A ²	50 µA	0.067% + 900 µA	10 µA	0.060% + 570 µA	
	3.00000 A ²	50 µA	0.059% + 2.8 mA	10 µA	0.052% + 1.71 mA	
	10.0000 µA	500 pA	0.033% + 2 nA	100 pA	0.027% + 700 pA	
	100.000 µA	5 nA	0.031% + 20 nA	1 nA	0.025% + 6 nA	
2430, 2430-C	1.00000 mA	50 nA	0.034% + 200 nA	10 nA	0.027% + 60 nA	±1.05A @ ±105 V (pulse mode only)
	10.0000 mA	500 nA	0.045% + 2 µA	100 nA	0.035% + 600 nA	
	100.000 mA	5 µA	0.066% + 20 µA	1 µA	0.055% + 6 µA	
	1.00000 A	50 µA	0.067% + 900 µA	10 µA	0.060% + 570 µA	
	3.00000 A ²	500 µA	0.059% + 2.8 mA	10 µA	0.052% + 1.71 mA	
	10.00000 A ⁴	500 µA	0.089% + 5.9 mA	10 µA	0.082% + 1.71 mA	
2440, 2440-C	10.0000 µA	500 pA	0.033% + 2 nA	100 pA	0.027% + 700 pA	±5.25A @ ±10.5 V ±1.05 A @ ±42 V
	100.000 µA	5 nA	0.031% + 20 nA	1 nA	0.025% + 6 nA	
	1.00000 mA	50 nA	0.034% + 200 nA	10 nA	0.027% + 60 nA	
	10.0000 mA	500 nA	0.045% + 2 µA	100 nA	0.035% + 600 nA	
	100.000 mA	5 µA	0.066% + 20 µA	1 µA	0.055% + 6 µA	
	1.00000 A	50 µA	0.067% + 900 µA	10 µA	0.060% + 570 µA	
5.00000 A	50 µA	0.10 % + 5.4 mA	10 µA	0.10 % + 3.42 mA		

TEMPERATURE COEFFICIENT (0°–18°C and 28°–50°C): ±(0.15 × accuracy specification)/°C.

CURRENT REGULATION: Line: 0.01% of range. Load: 0.01% of range (except Model 2440 5A range 0.05%) + 100pA.

VOLTAGE LIMIT: Bipolar voltage limit (compliance) set with single value. Min. 0.1% of range.

OVERSHOOT: <0.1% typical (1mA step, RL = 10kΩ, 20V range for Model 2400, 2401, 2410, 2420, 2425, 2430), (10V range for Model 2440).

CONTACT CHECK SPECIFICATIONS (requires -C version)

(Not available for Model 2401)

SPEED: 350µs for verification and notification.

CONTACT CHECK:	2 Ω	15 Ω	50 Ω
No contact check failure	<1.00 Ω	<13.5 Ω	<47.5 Ω
Always contact check failure	>3.00 Ω	>16.5 Ω	>52.5 Ω

NOTES

- 2400, 2401, 2410 Only: Specifications valid for continuous output currents below 105mA. For operation above 105mA continuous for >1 minute, derate accuracy 10%/35mA above 105mA.
- Full operation (1A) regardless of load to 30°C (50°C for Model 2420 and 2440). Above 30°C (50°C for Model 2420 and 2440) ambient, derate 35mA/°C and prorata 35mA/Ω load. 4-wire mode. For current sink operation on 1A, 3A, or 5A ranges, maximum continuous power is limited to approximately 1/2 rated power or less, depending on current, up to 30°C ambient. See power equations in the User's Manual to calculate allowable duty cycle for specific conditions.
- For sink mode, 1µA to 100mA range, accuracy is:
Model 2400, 2401: ±(0.15% + offset*4). Models 2410, 2420, 2425, 2430, 2440: ±(0.5% + offset*3).
For 1A range, accuracy is:
Model 2400, 2401: ±(1.5% + offset*8). Models 2410, 2420, 2425, 2430, 2440: ±(1.5% + offset*3).
- 10A range only in pulse mode. Limited to 2.5ms pulse width maximum. 10% duty cycle maximum.
- Speed = Normal (1 PLC). For 0.1 PLC, add 0.005% of range to offset specifications, except 200mV, 1A, 10A ranges, add 0.05%. For 0.01 PLC, add 0.05% of range to offset specifications, except 200mV, 1A, 10A ranges, add 0.5%.
- Accuracies apply to 2- or 4-wire mode when properly zeroed.
- In pulse mode, limited to 0.1 PLC measurement.
- Model 2400 and 2400-C only.

1.888.KEITHLEY (U.S. only)

www.keithley.com

A Greater Measure of Confidence

KEITHLEY

A Tektronix Company

Resistance Measurement Accuracy (Local or Remote Sense)^{1, 2, 5}

Range	Default Resolution	Default Test Current 2400, 2401, 2410	Default Test Current 2420, 2425, 2430, 2440	Normal Accuracy (23°C ±5°C) 1 Year, ±(% rdg. + ohms)			Enhanced Accuracy (23°C ±5°C) ⁴ 1 Year, ±(% rdg. + ohms)
				2400, 2401	2410	2420, 2425, 2430, 2440	2400, 2401
<0.20000 Ω ³	–	–	–	Source I _{ACC} + Meas. V _{ACC}	Source I _{ACC} + Meas. V _{ACC}	Source I _{ACC} + Meas. V _{ACC}	Source I _{ACC} + Meas. V _{ACC}
2.00000 Ω ³	10 μΩ	–	1 A	Source I _{ACC} + Meas. V _{ACC}	Source I _{ACC} + Meas. V _{ACC}	0.17% + 0.0003Ω	Source I _{ACC} + Meas. V _{ACC}
20.0000 Ω	100 μΩ	100 mA	100 mA	0.10% + 0.003 Ω	0.11% + 0.006 Ω	0.10% + 0.003 Ω	0.07% + 0.001 Ω
200.000 Ω	1 mΩ	10 mA	10 mA	0.08% + 0.03 Ω	0.09% + 0.1 Ω	0.08% + 0.03 Ω	0.05% + 0.01 Ω
2.00000 kΩ	10 mΩ	1 mA	1 mA	0.07% + 0.3 Ω	0.08% + 0.6 Ω	0.07% + 0.3 Ω	0.05% + 0.1 Ω
20.0000 kΩ	100 mΩ	100 μA	100 μA	0.06% + 3 Ω	0.07% + 6 Ω	0.06% + 3 Ω	0.04% + 1 Ω
200.000 kΩ	1 Ω	10 μA	10 μA	0.07% + 30 Ω	0.07% + 60 Ω	0.07% + 30 Ω	0.05% + 10 Ω
2.00000 MΩ ⁶	10 Ω	1 μA	1 μA	0.11% + 300 Ω	0.12% + 600 Ω	0.11% + 300 Ω	0.05% + 100 Ω
20.0000 MΩ ⁷	100 Ω	1 μA	1 μA	0.11% + 1 kΩ	0.12% + 2.4 kΩ	0.11% + 1 kΩ	0.05% + 500 Ω
200.000 MΩ ³	1 kΩ	100 nA	–	0.66% + 10 kΩ	0.66% + 24 kΩ	Source I _{ACC} + Meas. V _{ACC}	0.35% + 5 kΩ
>200.000 MΩ ³	–	–	–	Source I _{ACC} + Meas. V _{ACC}	Source I _{ACC} + Meas. V _{ACC}	Source I _{ACC} + Meas. V _{ACC}	Source I _{ACC} + Meas. V _{ACC}

TEMPERATURE COEFFICIENT (0°–18°C and 28°–50°C): ±(0.15 × accuracy specification)^{°C}.

SOURCE I MODE, MANUAL OHMS: Total uncertainty = I source accuracy + V measure accuracy (4-wire remote sense).

SOURCE V MODE, MANUAL OHMS: Total uncertainty = V source accuracy + I measure accuracy (4-wire remote sense).

6-WIRE OHMS MODE: Available using active ohms guard and guard sense. Max. Guard Output Current: 50mA (except 1A range). Accuracy is load dependent. Refer to White Paper no. 2033 for calculation formula.

GUARD OUTPUT IMPEDANCE: <0.1Ω in ohms mode.

NOTES

- Speed = Normal (1 PLC). For 0.1 PLC, add 0.005% of range to offset specifications, except 200mV, 1A, 10A ranges, add 0.05%. For 0.01 PLC, add 0.05% of range to offset specifications, except 200mV, 1A, 10A ranges, add 0.5%.
- Accuracies apply to 2- or 4-wire mode when properly zeroed.
- Manual ohms only – except 2420, 2425, 2430, 2440 for 2Ω range and 2400, 2401, or 2410 for 200MΩ range.
- Source readback enabled, offset compensation ON. Also available on 2410, 2420, 2425, 2430, and 2440 with similar accuracy enhancement.
- In pulse mode, limited to 0.1 PLC measurement.
- Except 2440; default test current is 5μA.
- Except 2440; default test current is 0.5μA.

SERVICES AVAILABLE

2400-3Y-EW	1-year factory warranty extended to 3 years from date of shipment
2400-C-3Y-EW	1-year factory warranty extended to 3 years from date of shipment
2401-3Y-EW	1-year factory warranty extended to 3 years from date of shipment
2410-3Y-EW	1-year factory warranty extended to 3 years from date of shipment
2410-C-3Y-EW	1-year factory warranty extended to 3 years from date of shipment
2420-3Y-EW	1-year factory warranty extended to 3 years from date of shipment
2420-C-3Y-EW	1-year factory warranty extended to 3 years from date of shipment
2425-3Y-EW	1-year factory warranty extended to 3 years from date of shipment
2425-C-3Y-EW	1-year factory warranty extended to 3 years from date of shipment
2430-3Y-EW	1-year factory warranty extended to 3 years from date of shipment
2430-C-3Y-EW	1-year factory warranty extended to 3 years from date of shipment
2440-3Y-EW	1-year factory warranty extended to 3 years from date of shipment
2440-C-3Y-EW	1-year factory warranty extended to 3 years from date of shipment
C/2400-3Y-ISO	3 (ISO-17025 accredited) calibrations within 3 years of purchase for Models 2400, 2400-C, 2400-IV*
C/2401-3Y-ISO	3 (ISO-17025 accredited) calibrations within 3 years of purchase for Model 2401*
C/2410-3Y-ISO	3 (ISO-17025 accredited) calibrations within 3 years of purchase for Models 2410, 2410-C*
C/2420-3Y-ISO	3 (ISO-17025 accredited) calibrations within 3 years of purchase for Models 2420, 2420-C*
C/2425-3Y-ISO	3 (ISO-17025 accredited) calibrations within 3 years of purchase for Models 2425, 2425-C*
C/2430-3Y-ISO	3 (ISO-17025 accredited) calibrations within 3 years of purchase for Models 2430, 2430-C*
C/2440-3Y-ISO	3 (ISO-17025 accredited) calibrations within 3 years of purchase for Models 2440, 2440-C*
TRN-2400-1-C	Course: Unleashing the Power of Your SourceMeter SMU Instrument

*Not available in all countries

System Speeds

MEASUREMENT¹

MAXIMUM RANGE CHANGE RATE: 75/second.

MAXIMUM MEASURE AUTORANGE TIME: 40ms (fixed source).²

Sweep Operation³ Reading Rates (rdg./second) for 60Hz (50Hz):

Speed	NPLC/Trigger Origin	Measure		Source-Measure		Source-Measure ⁵ Pass/Fail Test ^{4,5}		Source-Memory ⁴	
		To Mem.	To GPIB	To Mem.	To GPIB	To Mem.	To GPIB	To Mem.	To GPIB
Fast	0.01 / internal	2081 (2030)	1754	1551 (1515)	1369	902 (900)	981	165 (162)	165
IEEE-488.1 Mode	0.01 / external	1239 (1200)	1254	1018 (990)	1035	830 (830)	886	163 (160)	163
Fast	0.01 / internal	2081 (2030)	1198 (1210)	1551 (1515)	1000 (900)	902 (900)	809 (840)	165 (162)	164 (162)
IEEE-488.2 Mode	0.01 / external	1239 (1200)	1079 (1050)	1018 (990)	916 (835)	830 (830)	756 (780)	163 (160)	162 (160)
Medium	0.10 / internal	510 (433)	509 (433)	470 (405)	470 (410)	389 (343)	388 (343)	133 (126)	132 (126)
IEEE-488.2 Mode	0.10 / external	438 (380)	438 (380)	409 (360)	409 (365)	374 (333)	374 (333)	131 (125)	131 (125)
Normal	1.00 / internal	59 (49)	59 (49)	58 (48)	58 (48)	56 (47)	56 (47)	44 (38)	44 (38)
IEEE-488.2 Mode	1.00 / external	57 (48)	57 (48)	57 (48)	57 (47)	56 (47)	56 (47)	44 (38)	44 (38)

Single Reading Operation Reading Rates (rdg./second) for 60Hz (50Hz):

Speed	NPLC/Trigger Origin	Measure To GPIB	Source-Measure ⁵ To GPIB	Source-Measure Pass/Fail Test ^{4,5} To GPIB
Fast (488.1)	0.01 / internal	537	140	135
Fast (488.2)	0.01 / internal	256 (256)	79 (83)	79 (83)
Medium (488.2)	0.10 / internal	167 (166)	72 (70)	69 (70)
Normal (488.2)	1.00 / internal	49 (42)	34 (31)	35 (30)

Component for 60Hz (50Hz):^{4,6}

Speed	NPLC/Trigger Origin	Measure To GPIB	Source Pass/Fail Test	Source-Measure Pass/Fail Test ^{5,7} To GPIB
Fast	0.01 / external	1.04 ms (1.08 ms)	0.5 ms (0.5 ms)	4.82 ms (5.3 ms)
Medium	0.10 / external	2.55 ms (2.9 ms)	0.5 ms (0.5 ms)	6.27 ms (7.1 ms)
Normal	1.00 / external	17.53 ms (20.9 ms)	0.5 ms (0.5 ms)	21.31 ms (25.0 ms)

NOTES

¹ Reading rates applicable for voltage or current measurements. Auto zero off, autorange off, filter off, display off, trigger delay = 0, and binary reading format.

² Purely resistive load. 1 μ A and 10 μ A ranges <65ms.

³ 1000 point sweep was characterized with the source on a fixed range.

⁴ Pass/Fail test performed using one high limit and one low math limit.

⁵ Includes time to re-program source to a new level before making measurement.

⁶ Time from falling edge of START OF TEST signal to falling edge of END OF TEST signal.

⁷ Command processing time of :SOURCE:VOLTage|CURRENT:TRIGgered <nrf> command not included.

GENERAL

Noise Rejection:

	NPLC	NMRR	CMRR
Fast	0.01	—	80 dB
Medium	0.1	—	80 dB
Slow	1	60 dB	100 dB ¹

¹ Except lowest 2 current ranges = 90dB.

LOAD IMPEDANCE: Stable into 20,000pF typical.

COMMON MODE VOLTAGE: 250V DC (40V DC for Model 2440).

COMMON MODE ISOLATION: >10 Ω , <1000pF.

OVERRANGE: 105% of range, source and measure.

MAX. VOLTAGE DROP BETWEEN INPUT/OUTPUT AND SENSE TERMINALS: 5V.

MAX. SENSE LEAD RESISTANCE: 1M Ω for rated accuracy.

SENSE INPUT IMPEDANCE: >10 Ω .

GUARD OFFSET VOLTAGE: <150 μ V, typical (300 μ V for Models 2430, 2440).

SOURCE OUTPUT MODES:

- Pulse (Model 2430 only)
- Fixed DC level
- Memory List (mixed function)
- Stair (linear and log)

MEMORY BUFFER: 5,000 readings @ 5 digits (two 2,500 point buffers). Includes selected measured value(s) and time stamp. Lithium battery backup (3 yr+ battery life).

SOURCE MEMORY LIST: 100 points max.

PROGRAMMABILITY: IEEE-488 (SCPI-1995.0), RS-232, 5 user-definable power-up states plus factory default and *RST.

DIGITAL INTERFACE:

Interlock: Active low input.

Handler Interface: Start of test, end of test, 3 category bits. +5V@ 300mA supply. Not available on Model 2401.

Digital I/O: 1 trigger input, 4 TTL/Relay Drive outputs (33V @ 500mA, diode clamped). Not available on Model 2401.

POWER SUPPLY: 100V to 240V rms, 50–60Hz (automatically detected at power up). **Model 2400, 2401:** 190VA. **Model 2410:** 210VA. **Model 2420:** 220VA. **Model 2425, 2430:** 250VA. **Model 2440:** 240VA.

COOLING: **Model 2401:** Convection. **Model 2410, 2420, 2425, 2430, 2440:** Forced air, variable speed.

EMC: Conforms to European Union Directive 89/336/EEC, EN 61326-1.

SAFETY: UL listed to UL 61010B-1:2003: Conforms to European Union Low Voltage Directive.

VIBRATION: MIL-PRF-28800F Class 3 Random.

WARM-UP: 1 hour to rated accuracies.

DIMENSIONS: 89mm high \times 213mm wide \times 370mm deep (3 $\frac{1}{2}$ in \times 8 $\frac{3}{8}$ in \times 14 $\frac{1}{8}$ in). **Bench Configuration (with handle and feet):** 104mm high \times 238mm wide \times 370mm deep (4 $\frac{1}{8}$ in \times 9 $\frac{3}{8}$ in \times 14 $\frac{1}{8}$ in).

WEIGHT: 3.21kg (7.08 lbs) (Model 2425, 2430, 2440: 4.1kg, 9.0 lbs).

ENVIRONMENT: **Operating:** 0 $^{\circ}$ –50 $^{\circ}$ C, 70% R.H. up to 35 $^{\circ}$ C. Derate 3% R.H./ $^{\circ}$ C, 35 $^{\circ}$ –50 $^{\circ}$ C. **Storage:** –25 $^{\circ}$ C to 65 $^{\circ}$ C.

1.888.KEITHLEY (U.S. only)

www.keithley.com

KEITHLEY

A Greater Measure of Confidence

A Tektronix Company

Series 2400 SourceMeter[®] Family



KEITHLEY

A GREATER MEASURE OF CONFIDENCE

Streamline your production with precision voltage and current sourcing

SIMPLE • POWERFUL • UNLIMITED



A unique family of instruments to solve a wide range of challenging applications



and highly accurate measurement capabilities

Today, there's no reason to buy separate instruments for sourcing and measurement. Every instrument in Keithley's Series 2400 SourceMeter family gives you both capabilities in one compact unit. Each one combines a programmable power source with a highly repeatable, 5½-digit multimeter (DMM) in a half-rack-sized enclosure. You can use it as a voltage source, a current source, a voltage meter, a current meter, and an ohmmeter. There's a SourceMeter solution for just about any DC measurement challenge you can imagine. You can link any of them to a variety of component handlers for fast binning and sorting. Plus, SourceMeter instruments are fully compatible with Keithley's popular switching mainframes and cards for automating high speed, multipoint test applications.

- Perform high speed pass/fail testing and component binning
- Build I/V, I/R, V/I, and V/R curves with high resolution device characterization capabilities
- Measure resistance at any desired voltage or current level
- Source or sink power up to 1000W in pulse mode and 100W DC
- Create sophisticated ATE systems to streamline your production

Increasing throughput, yield, and productivity has

Maximize throughput, precision, and accuracy

SourceMeter instruments provide you with high throughput while delivering precision voltage and current sourcing and highly accurate measurements. Each model combines five tightly integrated instruments into one compact half-rack-sized unit: a voltage source, a current source, a voltage meter, a current meter, and an ohmmeter.

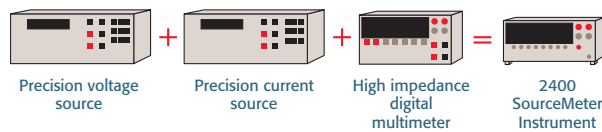

Increase productivity with high throughput and high yields

With the tight integration of a SourceMeter instrument, you'll get high speeds for high throughput and high measurement accuracy and repeatability for yield integrity. This tight integration also provides significant throughput advantages compared with multiple instrument systems. Each SourceMeter model is both a highly stable DC power source and a true instrument-grade 5½-digit multimeter (DMM). Its power source characteristics include low noise, precision, and readback. Its DMM capabilities include high repeatability as well as low noise.

Improve throughput with:

- Reading rates of more than 1750 readings/second to GPIB (IEEE-488.1 mode) and 2080 readings/second to memory
- Built-in comparator for pass/fail testing as fast as 500 μ s per point
- Built-in test sequencer and a 5000-point memory buffer for fast, multi-step tests and for minimizing GPIB traffic
- Keithley's Trigger Link interface for high speed triggering between instruments

Improve test yields and reduce false failures with:

- Optional contact check to verify good connection to the device under test in less than 350 μ s
- Basic measurement accuracy of 0.015% for volts, 0.035% for current, and 0.04% to 0.07% for ohms
- Unique 6-wire ohms capability for resistor network testing

Additional features that increase the usefulness of the SourceMeter family include:

- Fully programmable test signals and device protection thresholds for I, V, Ω , and power measurements
- Built-in sweeps for I/V, I/R, V/I, and V/R characterization
- Simplified programming with LabVIEW™ and TestPoint™ drivers
- Digital I/O with automated binning capability and built-in component handler interface
- Industry standard RS-232, IEEE-488.1, and IEEE-488.2 (GPIB) interfaces

Cost-effective and efficient

A SourceMeter instrument provides a good return on investment. You can expect great reliability, support, and service, as well as the need for only one instrument instead of many. Its compact half-rack size takes up minimal real estate, and its high accuracy measurements and robust design make it very dependable. When you need support or have questions, call our experienced Application Engineers or use the extensive library of application notes and example programs located on our web site. The versatile design and world-class performance of SourceMeter instruments make them ideal for a broad range of design and production applications in fields as diverse as communications, semiconductor, and components manufacturing.

Easy to use

A SourceMeter instrument is easy to set up and use. It provides convenient DMM-like operation, while eliminating many of the connection, compatibility, and synchronization problems that occur when multiple instruments are used. And, it allows you to source voltage or current while making measurements without changing connections. This not only makes it easier to use, it saves test time.

never been simpler



Measure functions operate like a DMM.

Source functions set up easily.

Dual-line VFD displays sourced value, measured value, and compliance level.

Obms measurements with user-programmable source current or clamp voltage

Fully programmable mathematical function key enables on-board calculation of derived parameters, such as power, voltage coefficient, ratio, etc.

Sense line impedance of >10GΩ won't disturb measurements.

5½-digit resolution provides sensitivity as low as 10⁻¹⁷ A and 1mV.

Source and measure from the same terminals.

Reading rates of up to 2080/s into memory, 1750/s over IEEE-488

5000-point memory buffer

3-stage limit structure for fast pass/fail testing

Choose from stair, log, or custom sweeps.

Bright, clear "output on" indicator

Programmable front/rear switching provides two independent channels that can be switched over the bus.

HIGH VERSATILITY



IEEE-488.1 or IEEE-488.2 for instrument control or to download commands for automatic execution. LabVIEW™ and TestPoint™ drivers are available.

Guard and Guard Sense lines provide unique 6-wire obms capability to guard out parallel resistors in networks.

RS-232 interface for direct connection to PC

Trigger Link feature provides two hardware trigger lines for fast, precise, repeatable triggering of switching systems.

Component handler interface has binning and pass/fail output.

Full range of testing capabilities

The instruments in the SourceMeter family offer wide versatility, so they make great solutions for a variety of applications in many industries. For seamless integration in fast multipoint testing applications, combine a SourceMeter instrument with a Keithley switch system. The examples outlined here represent only a fraction of the potential applications for these powerful test solutions. For details on these applications, including test system configurations, or for additional SourceMeter applications, visit our website at www.keithley.com.

SEAMLESS INTEGRATION FOR MULTI-POINT TESTING

Testing optoelectronic components

Use a SourceMeter instrument to measure a component's electrical performance characteristics and to drive laser diodes and other components.



Types of optoelectronic components:

- Laser diodes
- Laser diode modules
- Photodetectors
- Light-emitting diodes (LEDs)
- Photovoltaic cells

Typical tests:

- LIV test (laser diodes and LEDs)
- Kink test (laser diodes)
- I-V characterization

Testing resistors and resistor networks

Use a SourceMeter instrument to verify the performance of resistor networks at various stages in production, as well as in their final packaged form.

Types of devices:

- Thin-film or thick-film resistors and networks
- Dual terminator networks
- R/2R ladder networks
- Isolated and bussed networks
- Thermistors

Typical measurements:

- Circuit or buried node resistance
- Standard 4-wire and 6-wire Kelvin
- Percent deviation and ratio
- Isolation and trace resistance
- TCR (temperature coefficient of resistance) testing

Testing diodes

A SourceMeter instrument is ideal for testing devices with high voltage and high current, such as diodes.

Types of diodes:

- Switching diodes
- Zener diodes
- Radio frequency (RF) diodes

DC parametric tests:

- Forward voltage test
- Reverse breakdown test
- Leakage current test
- Polarity test
- Off-line QA analysis

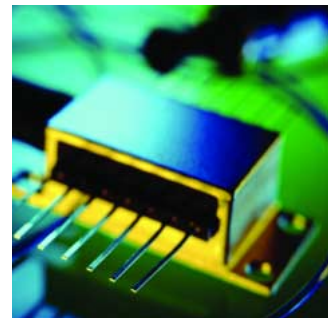



Testing circuit protection devices

A SourceMeter instrument is ideal for testing circuit protection devices, which can provide fast, energy absorbing, transient and over-voltage protection to a load placed across them.

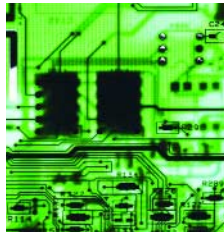

Types of circuit protection devices:

- TVS (transient voltage suppression)
- MOV (metal oxide varistor)
- Thermistors
- Polyfuses
- Fuses

Typical tests:

- Bipolar nominal voltage test
- Maximum clamping (breakdown) voltage test
- DC standby (leakage) current test
- Non-linear exponent (alpha coefficient) test

Testing ICs, RFICs, and MMICs

Use a SourceMeter instrument during the production testing of DC characteristics for a variety of IC technologies.

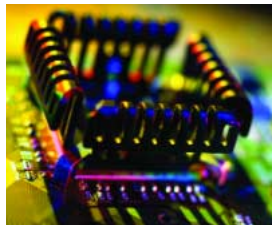

Typical tests:

- I_{DDQ} test
- DC parametric electrical test
- DC power source test

Testing air bag inflators

Use a SourceMeter instrument to test the electrical characteristics of the air bag assembly. The precision of a SourceMeter instrument and its readback feature make it ideal for this application, because testing the inflator is much like testing a fuse; if too high a current is used, the fuse will open and must be scrapped.

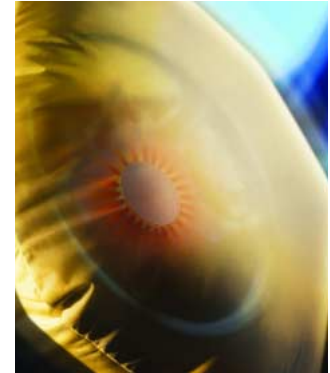

Typical tests:

- Bridgewire test
- Insulation resistance (HIPOT) test
- Shunt bar test
- Contact verification

Testing connectors, switches, and relays

Use a SourceMeter instrument to test your connectors, switches, and relays quickly and thoroughly with programmable test currents up to 5A. Quality connectors are vital to ensuring overall product reliability in applications ranging from motor vehicles to transatlantic telecom systems.

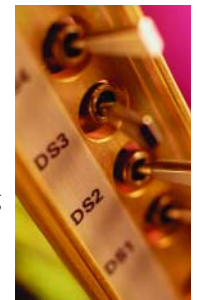

Typical tests for connectors:

- Isolation (insulation resistance)
- Pin continuity

Typical tests for connectors, switches, and relays:

- Contact resistance
- Offset compensation
- Insulation resistance
- Dielectric withstanding

Other applications

- AST (accelerated stress testing), including HALT/HASS and ESS
- GMR (giant magneto-resistive) head testing
- Battery discharge/charge cycling testing
- SOC (system on chip) testing



Faster, easier, and more efficient testing

FASTER, EASIER, AND MORE EFFICIENT

Coupled Source and Measure Capabilities

The tightly coupled nature of a SourceMeter instrument provides many advantages over separate instruments. The ability to fit a source and a meter in a single half-rack enclosure saves valuable rack space and simplifies the remote programming interface. Also, the tight control and single GPIB address inherent in a single instrument results in faster test times for ATE applications due to reduced GPIB traffic. The SourceMeter instrument topology (shown below) protects the device under test from damage due to accidental overloads, thermal runaway, and other problems. Both the current and voltage source are programmable with readback to help maximize device measurement integrity. If the readback reaches a programmed compliance limit, then the source is clamped at the limit, providing fault protection.

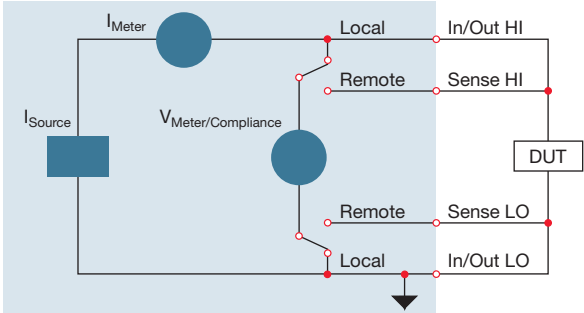

Source I, Measure V, I, or Ω configuration

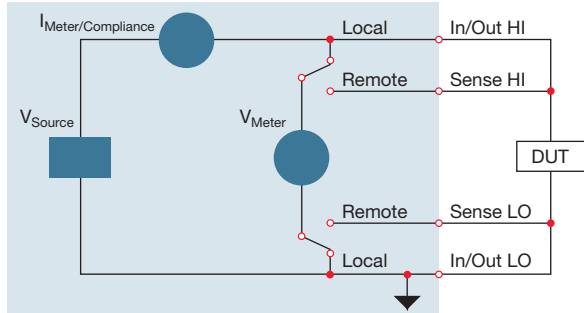

Source V, Measure I, V, or Ω configuration

Six-Wire Ohms Measurements

Use 6-wire ohms measurements to prevent measurement errors or when conventional methods won't work, such as when testing resistor networks, delta networks, and other hybrid circuits. Our unique 6-wire ohms technique uses Guard and Guard Sense leads in addition to the 4-wire Sense and Source leads to guard out parallel current paths when measuring networks or hybrid circuits. This avoids the complication of the DUT being shunted by other resistances in the circuit. This also allows you to test individual resistors buried inside a network without the need to break the circuit to isolate the component under test.

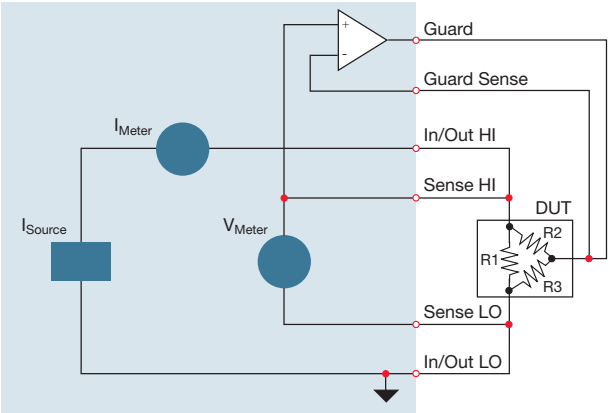

6-Wire Ohms Circuit - All test current flows through R1 because the high current guard drives the voltage across R2 to 0V.

Contact Check

The optional Contact Check function eliminates measurement errors and false product failures by verifying good connections to the device under test quickly and easily before testing begins. In just 350µs, this function's verification and notification routine ensures that you have good contact to a device before sending energy through it and spending time testing it. The Contact Check function was designed for high throughput 4-wire and 6-wire test applications, and it provides three methods of fault notification.

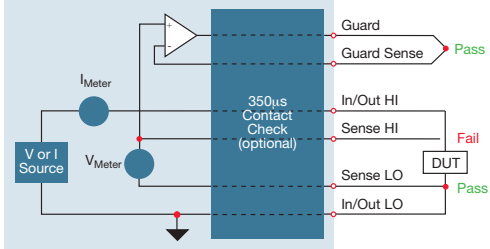

Contact check option for 4-wire or 6-wire applications

and automation



Standard and Custom Sweeps

SourceMeter instruments provide sweep solutions that greatly accelerate testing with automation hooks for additional throughput improvement. This is true whether you are performing sweeps on transistors, measuring Varistor Alpha, calculating slope efficiency on VCSELs, simply verifying connector integrity, or characterizing device performance, trip points, transfer functions, or virtually any DC volt-amp characteristic with high precision. Also use it for I/V, I/R, V/I, and V/R characterization.

There are three basic sweep waveforms to select from. The linear staircase sweep goes from the start level to the stop level in equal linear steps. The logarithmic staircase sweep is similar, but is done on a log scale with a specified number of steps per decade. The custom sweep allows construction of special sweeps by specifying the number of measurement points and the source level at each point. All sweep configurations can be programmed for single-event or continuous operation.

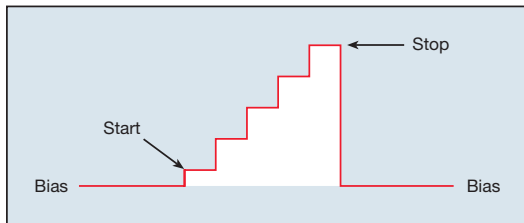

Linear staircase sweep

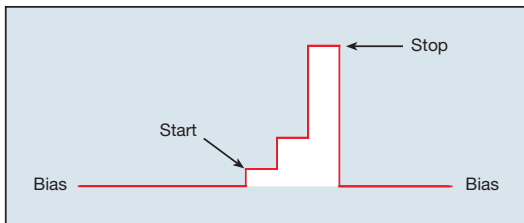

Logarithmic staircase sweep

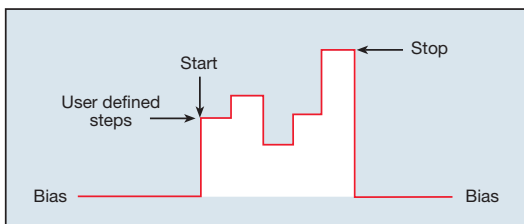

Custom sweep

Built-In Test Sequencer (Source Memory List)

For faster and easier testing, source memory list programmability is provided that allows you to set up and execute up to 100 different tests without PC intervention. Each test can contain different instrument configurations and test conditions, and can include source configurations, measurements, conditional branching, math functions, and pass/fail limit testing with binning capability. In addition, some SourceMeter models can include DC mode or pulse mode with varying parameters and timing (integration, delays, etc.), allowing you to slow down more sensitive measurements and speed up others to optimize overall timing.



Selecting the best solution for your

All SourceMeter instruments provide four-quadrant operation. In the first and third quadrants, they operate as a source, delivering power to a load. In the second and fourth quadrants, they operate as a sink, dissipating power internally. Voltage, current, and resistance can be measured during source or sink operation.

FOUR-QUADRANT OPERATION

Model 2400 SourceMeter Instrument

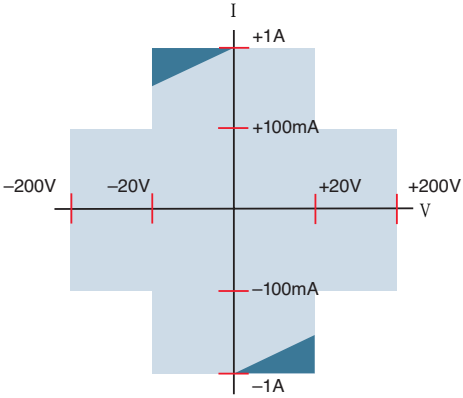

The Model 2400 is ideal for testing a wide variety of devices, including diodes, resistors, resistor networks, active circuit protection devices, and portable battery-powered devices and components.

Model 2420 3A SourceMeter Instrument

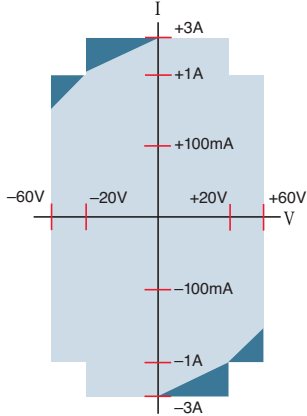

Choose the Model 2420 for testing higher power resistors, thermistors, I_{DDQ} , solar cells, batteries, and high current or medium power diodes, including switching and Schottky diodes.

Model 2410 High Voltage SourceMeter Instrument

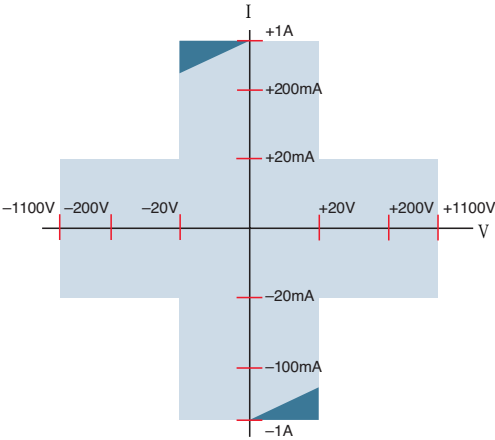

The Model 2410's high voltage capability makes it a good match for applications such as voltage coefficient testing of resistors, isolation and leakage current testing, and production testing/characterization of high voltage components, including varistors, RF diodes, and rectifiers.

Model 2425 100W SourceMeter Instrument

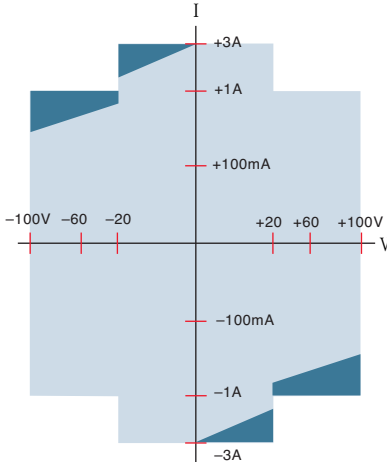

The Model 2425 offers continuous 100W programmable source and measurement capability for testing DC/DC converters, power semiconductor devices, and other high power components.

application



Model 2430 1kW Pulse Mode SourceMeter Instrument

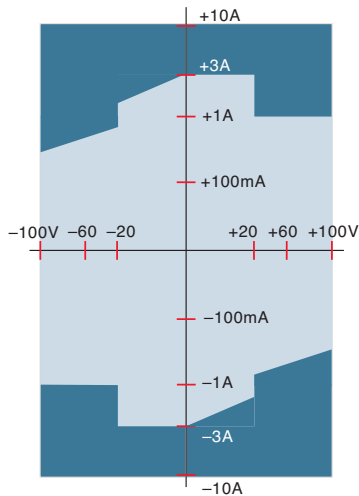

The Model 2430 combines a 1kW pulse capability with continuous 100W programmable source and measurement capability for production testing of devices like multi-layer varistors (MLVs), protection diodes, and other transient suppression devices.

Model 2440 5A SourceMeter Instrument

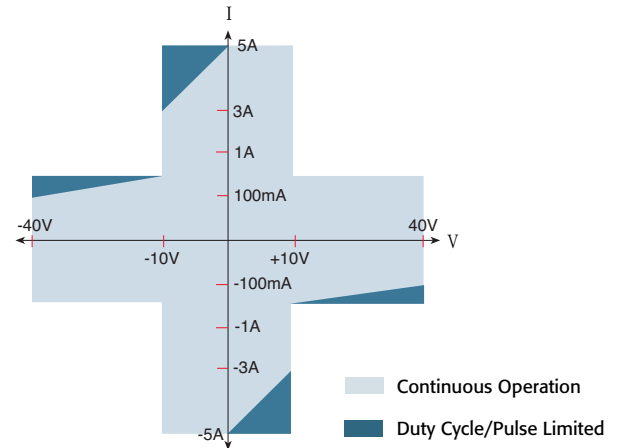

The Model 2440's wide dynamic range is well-suited for applications such as testing high power pump lasers for use in optical amplifiers and laser bar tests, as well as testing other higher power components.

Model	2400/ 2400-C*	2410/ 2410-C*	2420/ 2420-C*	2425/ 2425-C*	2430/ 2430-C*	2440/ 2440-C*	6430
Description	General Purpose	High Voltage	3 A	High Power	1000 W Pulse	5 A	Ultra-low Current
Power Output	20 W	20 W	60 W	100 W	100 W	50 W	2 W
Voltage Range	$\pm 1 \mu\text{V}$ to $\pm 210 \text{ V}$	$\pm 1 \mu\text{V}$ to $\pm 1100 \text{ V}$	$\pm 1 \mu\text{V}$ to $\pm 63 \text{ V}$	$\pm 1 \mu\text{V}$ to $\pm 105 \text{ V}$	$\pm 1 \mu\text{V}$ to $\pm 105 \text{ V}$	$\pm 1 \mu\text{V}$ to $\pm 42 \text{ V}$	$\pm 1 \mu\text{V}$ to $\pm 210 \text{ V}$
Current Range	$\pm 10 \text{ pA}$ to $\pm 1.05 \text{ A}$	$\pm 10 \text{ pA}$ to $\pm 1.05 \text{ A}$	$\pm 100 \text{ pA}$ to $\pm 3.15 \text{ A}$	$\pm 100 \text{ pA}$ to $\pm 3.15 \text{ A}$	$\pm 100 \text{ pA}$ to $\pm 10.5 \text{ A}$ (pulse)	$\pm 100 \text{ pA}$ to $\pm 5.25 \text{ A}$	$\pm 10 \text{ aA}^{**}$ to $\pm 105 \text{ mA}$
Ohms Range	$<0.2 \Omega$ to $>200 \Omega$	$<0.2 \Omega$ to $>200 \text{ M}\Omega$	$<0.2 \Omega$ to $>200 \text{ M}\Omega$	$<0.2 \Omega$ to $>200 \text{ M}\Omega$	$<0.2 \Omega$ to $>200 \text{ M}\Omega$	$<2.0 \Omega$ to $>200 \text{ M}\Omega$	$<2.0 \Omega$ to $>20 \text{ T}\Omega^{***}$
Applications	<ul style="list-style-type: none"> Resistive devices Diodes Optoelectronic components I_{DDQ} testing 	<ul style="list-style-type: none"> Voltage coefficient Varistors High voltage diodes and protection devices Airbag inflators 	<ul style="list-style-type: none"> Power resistors Thermistors Solar cells Batteries Diodes I_{DDQ} testing 	<ul style="list-style-type: none"> Power semi-conductors DC/DC converters High power components I_{DDQ} testing 	<ul style="list-style-type: none"> High power pulse testing Varistors and other circuit protection devices 	<ul style="list-style-type: none"> 5A pump laser diodes 	<ul style="list-style-type: none"> Particle beam experiments SET (single electron transistor) testing Ultra-high resistance testing (up to $10^5 \Omega$)

* A model number ending with "-C" indicates the Contact Check function

** 1aA = 1×10^{-18} amps

*** 1T Ω = 10×10^{12} ohms

Everything you need to create a customized

For a fast, efficient, cost-effective system

Keithley can provide you with a wide variety of accessories, switching systems, and support, so you can create a solution that is exactly tailored to your needs. Our Application Engineers can help you decide which configurations are best suited to your situation.

Switching systems

For your multiple test point applications, combine a Keithley switch system with your SourceMeter instrument for a seamless, complete solution. You can count on our switch systems to provide the characteristics needed to maintain signal integrity and the flexibility to accommodate a wide range of signals.

Series 7000 Switch Systems

The Model 7001 is a half-rack, 80-channel, 2-slot mainframe with the highest density switching of any half-rack mainframe in the test and measurement market. Its unique front panel display clearly shows the open/closed status of every channel. Programming at the front panel or over the IEEE bus includes parameters such as scan spacing, channel spacing, number of scans, and trigger source.



The Model 7002 is a 10-slot mainframe that can support up to 400 2-pole multiplexer channels or 400 matrix crosspoints. Its unique interactive front panel channel status display offers light-pen programming.



Series 7000 Switch Cards

These switch cards provide you with sensitivity and accuracy that matches the instrument, so you can achieve seamless interfacing between SourceMeter instruments and the Model 7001 and 7002 High Density Switch Systems.

There are more than 40 types of cards, including multiplexer, matrix, multi-channel relay, thermocouple, scanner, universal adapter, and RF cards.



Model 707A/708A Switch Matrix Systems

These switch matrix systems offer advanced solutions to test engineers involved in production testing of semiconductor devices, telecommunications equipment and other electronic products. The Model 707A is a 6-slot mainframe for control of up to 576 channels, while the 708A includes a single slot for up to 96 channels.



Integra Series Switch/Measurement Systems

When you need higher accuracy, use these systems. They also provide you with the functionality of a DMM, a switching system, a data acquisition system, and a data logger in compact, affordable, easy-to-configure packages. With 80- or 200-channel capacity, these systems allow you to choose from a variety of switch/control plug-in modules, so you can easily customize a system to the needs of your application. Choose from GPIB, RS-232, or Ethernet communication options. Outstanding features of the Model 2750 include world-class low power, low ohms performance and dry circuit and offset compensation capabilities.



test solution



RF/Microwave Switching

System 40/41/S46 and

Model 7116-MWS RF/Microwave Signal

Routing Systems

When you need to integrate a variety of RF components, low frequency switching, power switching, and/or digital I/O into one system, our System 40/41/S46 and Model 7116-MWS switching systems will meet your needs. These switching systems provide both standard and custom configurations.



Optoelectronic Instrumentation

System 25

Keithley's System 25 LIV (light-current-voltage) Test System Kit combines all the DC measurement capabilities required to test laser diode modules with optical power measurement and tight temperature control over the device under test in an integrated instrument package. The LIV test system is configured from proven Keithley instrumentation; the basic configuration can be easily modified to add new measurement functions or to allow for new connections.



Available Accessories:

Communication

KPC-488.2AT, KPCI-488 GPIB/IEEE-488 Interface Boards
7007-, 7007-2 Double-Shielded, Premium GPIB

Cables

7009-5 RS-232 Cable

Test Leads

1754 2-Wire Universal 10 Piece Test

Lead Kit

5804 Kelvin (4-Wire) Universal 10

Piece

5805

Test Lead Kit
Kelvin (4-Wire) Spring-Loaded

Probes

5806

Kelvin (4-Wire) Oversized

Alligator

Clip-on Leads

Triggering and Control

KPC-TM

TriggerMaster Interface

8501-1, 8501-2

Trigger-Link Cables

8502, 8503, 8505

Trigger-Link Adapters

2499-DIGIO

Digital I/O Expander
Assembly

Other

TestPoint

Test Development Software

Model 2502 Dual Photodiode Meter

Designed for Keithley's L-I-V production test systems, the Model 2502 provides two 100V bias sources and two high speed picoammeters in a single half-rack enclosure.

It supplies the voltage bias and current measurement for two photodetectors simultaneously. The Model 2502 is compatible with the Model 2500INT Integrating Sphere for optical power measurements.



Model 2510/2510-AT Autotuning TEC SourceMeter Instrument

The Model 2510 powers a laser diode's ThermoElectric Cooler (TEC), providing precise P-I-D (Proportional, Integral, and Derivative) temperature control of the device under test. The Model 2510-AT expands these capabilities with a built-in autotuning algorithm. The autotune feature calculates the best P, I, and D coefficients for optimal closed-loop temperature control.

Specifications

These condensed specifications provide a valuable overview of the SourceMeter family. For complete specifications, visit our web site (www.keithley.com) or call us at 1-888-KEITHLEY (534-8453) to speak with one of our experienced applications engineers or to ask for data sheets of the models that interest you.

SourceMeter® Family

	2400(-C)	2410(-C)	2420(-C)	2425(-C)	2430(-C)	2440(-C)	6430
Volts Ranges	0.2, 2, 20, 200 V	0.2, 2, 20, 1000 V	0.2, 2, 20, 60 V	0.2, 2, 20, 100 V	0.2, 2, 20, 100 V	0.2, 2, 20, 40 V	0.2, 2, 20, 200 V
Basic V Source Accuracy	0.02%	0.02%	0.02%	0.02%	0.02%	0.02%	0.02%
Basic V Measure Accuracy	0.015%	0.015%	0.015%	0.015%	0.015%	0.015%	0.015%
I Ranges	1, 10, 100 μ A 1, 10, 100 mA 1 A	1, 10, 100 μ A 1, 10, 100 mA 1 A	10, 100 μ A 1, 10, 100 mA 1 A, 3 A	10, 100 μ A 1, 10, 100 mA 1 A, 3A	10, 100 μ A 1, 10, 100 mA 1 A, 3 A, 10 A	10, 100 μ A 1, 10, 100 mA 1 A, 5 A	1, 10, 100 pA 1, 10, 100 nA 1, 10, 100 μ A 1, 10, 100 mA
Basic I Source Accuracy	0.045%	0.045%	0.045%	0.045%	0.045%	0.045%	0.045%
Basic I Measure Accuracy	0.035%	0.035%	0.035%	0.035%	0.035%	0.035%	0.035%
Ohms Ranges	20, 200 Ω 2, 20, 200 k Ω 2, 20, 200 M Ω	20, 200 Ω 2, 20, 200 k Ω 2, 20, 200 M Ω	2, 20, 200 Ω 2, 20, 200 k Ω 2, 20 M Ω	2, 20, 200 Ω 2, 20, 200 k Ω 2, 20 M Ω	2, 20, 200 Ω 2, 20, 200 k Ω 2, 20 M Ω	2, 20, 200 Ω 2, 20, 200 k Ω 2, 20 M Ω	20, 200 Ω 2, 20, 200 k Ω 2, 20, 200 M Ω 2, 20, 200 G Ω 2, 20 T Ω
Basic Ohms Measure Accuracy	0.06%	0.07%	0.06%	0.06%	0.06%	0.06%	0.06%

Additional Source Specifications

VOLTAGE REGULATION: Line: 0.01% of range. Load: 0.01% of range + 100 μ V.

NOISE 10Hz–1MHz (p-p): 10mV (50mV typ., Models 2430 and 2440).

OVER VOLTAGE PROTECTION: User selectable values, 5% tolerance. Factory default = none.

CURRENT LIMIT: Bipolar current limit (compliance) set with single value. Min. 0.1% of range.

OVERSHOOT: <0.1% typical (full scale step, resistive load, 10mA range).

CURRENT REGULATION: Line: 0.01% of range. Load: 0.01% of range (except Model 2440 5A range 0.5% + 100pA).

VOLTAGE LIMIT: Bipolar voltage limit (compliance) set with single value. Min. 0.1% of range.

OVERSHOOT: <0.1% typical (1mA step, $R_L = 10k\Omega$, 20V range for Model 2400, 2410, 2420, 2425, 2430) (10V range for Model 2440).

OUTPUT SETTLING TIME: Time required to reach 0.1% of final value after command is processed. 100 μ s typical. Resistive load. 10 μ A to 100mA range.

DC FLOATING VOLTAGE: Output can be floated up to $\pm 250V$ DC (Model 2440 $\pm 40V$ DC) from chassis ground.

REMOTE SENSE: Up to 1V drop per load lead.

COMPLIANCE ACCURACY: Add 0.3% of range and $\pm 0.02%$ of reading to base specification.

Additional Measure Specification

SOURCE I MODE, MANUAL OHMS: Total uncertainty = I source accuracy + V measure accuracy (4-wire remote sense).

SOURCE V MODE, MANUAL OHMS: Total uncertainty = V source accuracy + I measure accuracy (4-wire remote sense).

6-WIRE OHMS MODE: Available using active ohms guard and guard sense. Max. Guard Output Current: 50mA (except 1, 3, 5, 10A and 1000V ranges). Accuracy is load dependent. Refer to White Paper No. 2033 for calculation formula.

GUARD OUTPUT IMPEDANCE: <0.1 Ω in ohms mode.

Contact Check Specifications

SPEED: 350 μ s for verification and notification.

CONTACT CHECK:	2 Ω	15 Ω	50 Ω
No contact check failure	<1.00 Ω	<13.5 Ω	<47.5 Ω
Always contact check failure	>3.00 Ω	>16.5 Ω	>52.5 Ω

System Speeds

Measurement¹

MAXIMUM RANGE CHANGE RATE: 75/second.

MAXIMUM MEASURE AUTORANGE TIME: 40ms (fixed source).²

Sweep Operation³ Reading Rates (rdg./second) for 60Hz (50Hz):

SPEED	NPLC/TRIGGER ORIGIN	MEASURE		SOURCE-MEASURE ⁵		SOURCE-MEASURE PASS/FAIL TEST ^{4,5}		SOURCE-MEMORY ⁴	
		TO MEM.	TO GPIB	TO MEM.	TO GPIB	TO MEM.	TO GPIB	TO MEM.	TO GPIB
Fast	0.01 / internal	2081(2030)	1754	1551(1515)	1369	902(900)	981	165(162)	165
IEEE-488.1 Mode	0.01 / external	1239(1200)	1254	1018(990)	1035	830(830)	886	163(160)	163
Fast	0.01 / internal	2081(2030)	1198(1210)	1551(1515)	1000(900)	902(900)	809(840)	165(162)	164(162)
IEEE-488.2 Mode	0.01 / external	1239(1200)	1079(1050)	1018(990)	916(835)	830(830)	756(780)	163(160)	162(160)
Medium	0.10 / internal	510(433)	509(433)	470(405)	470(410)	389(343)	388(343)	133(126)	132(126)
IEEE-488.2 Mode	0.10 / external	438(380)	438(380)	409(360)	409(365)	374(333)	374(333)	131(125)	131(125)
Normal	1.00 / internal	59(49)	59(49)	58(48)	58(48)	56(47)	56(47)	44(38)	44(38)
IEEE-488.2 Mode	1.00 / external	57(48)	57(48)	57(48)	57(47)	56(47)	56(47)	44(38)	44(38)

Single reading operation reading rates (rdg./second) for 60Hz (50Hz):

SPEED	NPLC/TRIGGER ORIGIN	MEASURE TO GPIB	SOURCE-MEASURE ⁵ TO GPIB	SOURCE-MEASURE PASS/FAIL TEST ^{4,5} TO GPIB
Fast (488.1)	0.01 / internal	537	140	135
Fast (488.2)	0.01 / internal	256(256)	79(83)	79(83)
Medium(488.2)	0.10 / internal	167(166)	72(70)	69(70)
Normal (488.2)	1.00 / internal	49(42)	34(31)	35(30)

Component for 60Hz (50Hz):^{4,6}

SPEED	NPLC/TRIGGER ORIGIN	MEASURE TO GPIB	SOURCE PASS/FAIL TEST	SOURCE-MEASURE PASS/FAIL TEST ^{5,7} TO GPIB
Fast	0.01 / external	1.04 ms (1.08 ms)	0.5 ms (0.5 ms)	4.82 ms (5.3 ms)
Medium	0.10 / external	2.55 ms (2.9 ms)	0.5 ms (0.5 ms)	6.27 ms (7.1 ms)
Normal	1.00 / external	17.53 ms (20.9 ms)	0.5 ms (0.5 ms)	21.31 ms (25.0 ms)

¹ Reading rates applicable for voltage or current measurements. Auto zero off, autorange off, filter off, display off, trigger delay = 0, and binary reading format.

² Purely resistive load. 1 μ A and 10 μ A ranges <65ms.

³ 1000 point sweep is characterized with the source on a fixed range.

⁴ Pass/Fail test performed using one high limit and one low math limit.

⁵ Includes time to re-program source to a new level before making measurement.

⁶ Time from falling edge of START OF TEST signal to falling edge of END OF TEST signal.

⁷ Command processing time of :SOURCE:VOLTage|CURRENT:TRIGGERed <nrf> command not included.

GENERAL

Noise Rejection:

	NPLC	NMRR	CMRR
Fast	0.01	—	80 dB
Medium	0.1	—	80 dB
Slow	1	60 dB	100 dB ¹

¹ Except lowest 2 current ranges = 90dB.

LOAD IMPEDANCE: Stable into 20,000pF typical.

COMMON MODE VOLTAGE: 250V DC (40V DC for Model 2440).

COMMON MODE ISOLATION: >10⁹ Ω , <1000pF.

OVERRRANGE: 105% of range, source and measure.

MAX. VOLTAGE DROP BETWEEN INPUT/OUTPUT AND SENSE TERMINALS: 5V.

MAX. SENSE LEAD RESISTANCE: 1M Ω for rated accuracy.

SENSE INPUT IMPEDANCE: >10¹⁰ Ω .

GUARD OFFSET VOLTAGE: <300 μ V, typical.

SOURCE OUTPUT MODES:

- Pulse (Model 2430 only)
- Fixed DC level
- Memory List (mixed function)
- Stair (linear and log)

SOURCE MEMORY LIST: 100 points max.

MEMORY BUFFER: 5,000 readings @ 5 digits (two 2,500 point buffers). Includes

selected measured value(s) and time stamp. Lithium battery backup (3 yr+ battery life).

PROGRAMMABILITY: IEEE-488 (SCPI-1995.0), RS-232, 5 user-definable power-up states plus factory default and *RST.

DIGITAL INTERFACE:

Interlock: Active low input.

Handler Interface: Start of test, end of test, 3 category bits. +5V@ 300mA supply.

Digital I/O: 1 trigger input, 4 TTL/Relay Drive outputs (33V @ 500mA, diode clamped).

POWER SUPPLY: 100V to 240V rms, 50–60Hz (automatically detected at power up). Model 2400: 190VA. Model 2410: 210VA. Model 2420: 220VA. Model 2425, 2430: 250VA. Model 2440: 240VA.

COOLING: (Model 2410, 2420, 2425, 2430, 2440): Forced air, variable speed.

WARRANTY: 1 year.

EMC: Conforms to European Union Directive 89/336/EEC, EN 61326-1.

SAFETY: Conforms to European Union Directive 73/23/EEC, EN61010-1.

WARM-UP: 1 hour to rated accuracies.

DIMENSIONS: 89mm high x 213mm wide x 370mm deep (3 $\frac{1}{2}$ " in x 8 $\frac{3}{8}$ " in x 14 $\frac{9}{16}$ " in). Bench Configuration (with handle & feet): 104mm high x 238mm wide x 370mm deep (4 $\frac{1}{8}$ " in x 9 $\frac{3}{8}$ " in x 14 $\frac{9}{16}$ " in).

Informative reference materials

Visit our web site, www.keithley.com, to access our reference library, including:

Switching Handbook

This valuable publication describes relay characteristics, switching specifications, selection criteria, system integration hints, and guidelines for optimizing your test system.



Low Level Measurements

This informative handbook describes theoretical and practical considerations involved in the measurement of low DC currents, high resistances, and low DC voltages.



Application Notes

These helpful notes include practical, real-world answers to many application questions related to SourceMeter instruments.

Service you can depend on

When you need help, contact us at www.keithley.com or call us at **1-888-KEITHLEY (534-8453)**. Whatever your application, Keithley's application engineers are ready to help you meet its challenges, before and after the sale. You can rely on us to suggest the most effective system configurations and to provide prompt, reliable applications support once your system is set up.

The next time you're faced with a challenging application, give us a call. We'll offer you a cost-effective solution that will help you improve your product quality, throughput, and yield.

Keithley's commitment to the electronics manufacturing industry

Keithley has more than 50 years of experience in applying our world leadership in low-level measurements to produce solutions for your industry's needs. Backed by R&D, customer feedback, partnerships, and strategic alliances, the result has been accurate and reliable DMMs, Source-Measure Units, switching systems, I/V characterization systems, and much, much more. The Series 2400 SourceMeter family continues this tradition, along with our heritage of Quality, Service, Innovation, and Integrity (QSII).

Specifications are subject to change without notice.

All Keithley trademarks and trade names are the property of Keithley Instruments, Inc.

All other trademarks and trade names are the property of their respective companies.

KEITHLEY

A G R E A T E R M E A S U R E O F C O N F I D E N C E

Keithley Instruments, Inc.

Corporate Headquarters • 28775 Aurora Road • Cleveland, Ohio 44139 • 440-248-0400 • Fax: 440-248-6168 • 1-888-KEITHLEY (534-8453) • www.keithley.com

Belgium: Sint-Pieters-Leeuw • 02-363 00 40 • Fax: 02-363 00 64 • www.keithley.nl

China: Beijing • 8610-82251886 • Fax: 8610-82251892 • www.keithley.com.cn

Finland: Helsinki • 09-5306-6560 • Fax: 09-5306-6565 • www.keithley.com

France: Palaiseau Cédex • 01-64 53 20 20 • Fax: 01-60 11 77 26 • www.keithley.fr

Germany: Germering • 089/84 93 07-40 • Fax: 089/84 93 07-34 • www.keithley.de

Great Britain: Theale • 0118 929 7500 • Fax: 0118 929 7519 • www.keithley.co.uk

India: Bangalore • 080 212 8027 • Fax : 080 212 8005 • www.keithley.com

Taiwan: Hsinchu • 886-3-572-9077 • Fax: 886-3-572-9031 • www.keithley.com.tw

Italy: Milano • 02-48 39 16 01 • Fax: 02-48 30 22 74 • www.keithley.it

Japan: Tokyo • 81-3-5733-7555 • Fax: 81-3-5733-7556 • www.keithley.jp

Korea: Seoul • 82-2-574-7778 • Fax: 82-2-574-7838 • www.keithley.com

Netherlands: Gorinchem • 0183-635333 • Fax: 0183-630821 • www.keithley.nl

Singapore: Singapore • 65-6747-9077 • Fax: 65-6747-2991 • www.keithley.com

Sweden: Solna • 08-509 04 600 • Fax: 08-655 26 10 • www.keithley.com

Switzerland: Zurich • 01-821 94 44 • Fax: 01-820 30 81 • www.keithley.ch