

Operation Manual

ML248xB / ML249xA Wideband Peak Power Meter

The Anritsu logo is located in the bottom right corner of the page. It consists of the word "Anritsu" in a bold, blue, sans-serif font. The letter "A" is stylized with a diagonal slash through it.

Table of Contents

Chapter 1—General Information

1-2	Associated Documentation and Software	1-1
	Firmware Versions	1-1
1-3	Conventions	1-2
1-4	Performance Verification	1-2

Chapter 2—Product Overview

2-1	Overview	2-1
2-2	Model Types	2-1
2-3	Features	2-2
	Ease of operability	2-2
	Dual channel display	2-2
	Large colour display with graphical MMI	2-2
	Video output	2-2
	Enhanced Measurement Bandwidth	2-2
	Two sampling modes	2-2
	High speed sampling	2-2
	Compatibility	2-3
	Remote interface	2-3
	Secure mode	2-3
2-4	Available Options, Accessories, and Power Sensors	2-3
2-5	Associated Products	2-3
	Power Meter (Universal) ML243xA series	2-3
	MS268xA Series Spectrum Analyzer	2-3

Chapter 3—Assembly and Connections

3-1	Initial Inspection	3-1
3-2	Shipped Items	3-1
3-3	Storage and Repackaging	3-2
	Environmental Requirements	3-2
	Preparation for Shipment	3-2
3-4	Rack Mounting	3-2
3-5	Power Requirements	3-3
	AC Line Power	3-3
	Fuses	3-3
	Grounding	3-3
	Environmental Requirements	3-3
3-6	Rear Panel Connections	3-4

Table of Contents (Continued)**Chapter 4—Front Panel Layout and Operation**

4-1	Power-On Procedure	4-1
4-2	The Front Panel	4-2
4-3	The Numeric Keypad	4-3
4-4	The Hard Keys	4-4
4-5	The Screen	4-5
4-6	Sensor Information	4-6
4-7	Channel Information	4-7
4-8	Status Bar	4-9
4-9	The Soft Keys	4-10
4-10	Dialog Boxes	4-12
4-11	The Connectors	4-13
4-12	Data Entry Procedure	4-14
	Numeric Entry Example	4-14
	Text Entry	4-15
	Power-Off Procedure	4-15

Chapter 5—Channel Menu Reference

5-1	Understanding and Setting Up the Channels	5-1
	Sensor Inputs	5-1
	Channels	5-1
	Modes	5-1
	Measurement Displays	5-2
	Channel Configuration Overview	5-3
5-2	Selecting the Measurement Mode	5-4
5-3	Selecting the Measurement Type	5-5
5-4	Selecting the Measurement Display Style	5-6
5-5	Selecting the Sensor Input (ML2488B and ML2496A only)	5-7
5-6	Setting the Units of Measurement	5-8
5-7	Selecting the Resolution	5-9
5-8	Entering the Settling Percentage	5-9
5-9	Selecting Dual Display Channel Mode	5-10
	Setting Up the Second Channel	5-10
5-10	Displaying Both Channels Simultaneously	5-11
5-11	Understanding Triggering	5-12
5-12	Selecting the Triggering Mechanism	5-13
5-13	Selecting the Type of Triggering	5-14

Table of Contents (Continued)

5-14	Entering the Triggering Capture Time	5-15
	Random Repetitive Sampling (RRS) (ML249xA only)	5-16
5-15	Entering the Triggering Delay	5-17
5-16	Enabling Auto Triggering	5-17
5-17	Entering the Triggering Level	5-18
5-18	Selecting the Trigger Arming Method	5-19
5-19	Entering a Frame Arming Level and Duration	5-20
5-20	Setting the Sampling Rate	5-20
5-21	Selecting the Trigger Indicator	5-21
5-22	Linking the Channel Trigger Settings	5-22
5-23	Gates and Fences	5-22
5-24	Setting Up and Enabling Gates and Fences.	5-24
5-26	Setting the Active Gate	5-26
5-27	Setting Up Repeat Gates	5-26
5-28	Averaging	5-27
	Setting Up Averaging.	5-27
5-29	Enabling Averaging in Pulsed/Modulated Mode	5-28
5-30	Enabling Averaging in CW Mode	5-29
5-31	Restarting Averaging in Pulsed/Modulated Mode.	5-30
5-32	Markers.	5-30
5-33	Setting Markers.	5-31
5-34	Turning all Markers Off.	5-32
5-35	Setting and Viewing the Active Marker.	5-32
5-36	Positioning the Active Marker	5-33
	Method 1	5-33
	Method 2	5-33
5-37	Positioning the Delta Marker.	5-33
	Method 1	5-33
	Method 2	5-34
5-38	Setting the Delta Marker Calculation	5-34
5-39	Linking the Delta Marker to the Active Marker	5-34
5-40	Moving the Active Marker to the Maximum Point	5-34
5-41	Moving the Active Marker to the Minimum Point	5-35
5-42	Zooming In or Out on the Active Marker.	5-35
5-43	Measuring the Pulse Rise Time	5-35
5-44	Measuring the Pulse Fall Time	5-36
5-45	Measuring the Pulse Width.	5-37

Table of Contents (Continued)

5-46	Measuring the Off Time	5-38
5-47	Measuring the Pulse Repetition Interval	5-39
5-48	Setting the Search Target Levels	5-40
5-49	Setting the Duty Cycle in CW Mode	5-41
5-50	Limits	5-41
5-51	Creating and Viewing Simple Limits	5-41
5-52	Creating and Saving Complex Limits	5-42
5-53	Recalling User or Predefined Complex Limits	5-44
5-54	Editing Complex Limits	5-45
5-55	Repeating Limits	5-46
5-56	Holding the Limit Fail Indicator	5-46
5-57	Sounding an Alarm on Limit Failure	5-47
5-58	Adjusting and Resetting the Trace Measurement Scale	5-47
5-59	Setting the Profile Display Style	5-48
5-60	Setting the Profile Display Data Hold Method	5-49
5-61	Holding Measurement Data in the Currently Active Channel	5-50
5-62	Setting the Peaking Indicator	5-50
5-63	Post Processing	5-51
5-64	Statistical Post Processing	5-53
5-65	PAE Post Processing	5-54
5-66	Setting the Cursor Position	5-56
5-67	Zooming In or Out on the Cursor Position	5-56

Chapter 6—Sensor Menu Reference

6-1	Setting Up the Sensor in Use	6-1
6-3	Setting the Power Offset Applied to the Sensors	6-3
6-4	Editing Cal Factor Tables	6-4
6-5	Creating New Cal Factor Tables	6-5
6-6	Editing the Sensor Offset Tables	6-7
6-7	Creating New Sensor Offset Tables	6-7
6-8	Holding Sensors on the Current Range	6-9

Chapter 7—Cal/Zero Menu Reference

7-1	Zeroing the Sensor	7-1
7-2	Zeroing and Calibrating the Sensor	7-1
7-3	Performing a Zero dBm Calibration	7-2
7-4	Zeroing the Rear Panel BNC Connector	7-2

Table of Contents (Continued)

Chapter 8—System Menu Reference

8-1	Saving Instrument Settings	8-1
8-2	Recalling Instrument Settings	8-2
8-3	Displaying and Changing the Screen Title	8-2
8-4	Capturing the Screen Image	8-3
8-5	Changing the Brightness of the Display Backlight	8-5
8-6	Setting the GPIB Address for the Instrument	8-5
8-7	Enabling Buffering of the GPIB Output	8-6
8-8	Setting the RS232 Serial Port Baud Rate	8-6
8-9	Setting the LAN IP Address	8-7
8-10	Setting the Static IP Address	8-7
8-11	Configuring the Rear Panel Outputs	8-7
8-12	Turning the Key Click On or Off	8-10
8-13	Setting Increment and Decrement Steps	8-10
8-14	Viewing the Instrument Identity Dialog	8-11
8-15	Turning the Security Feature On or Off	8-11
8-16	Diagnostics	8-11
8-17	Upgrading the System Software	8-12

Chapter 9—Preset Menu Reference

9-1	Resetting the System	9-1
9-2	Using the Preset Configurations	9-1

Chapter 10—Remote Operation

10-1	Overview of GPIB	10-1
10-2	Overview of Ethernet	10-1

Chapter 11—CW Setup and Measurement

11-1	Setting Up the Power Meter for CW Measurements	11-1
------	--	------

Chapter 12—GSM Setup and Measurement

12-1	Setting Up the Power Meter for GSM Measurements	12-1
------	---	------

Chapter 13—CDMA Setup and Measurement

13-1	Setting Up the Power Meter for CDMA Measurements	13-1
------	--	------

Chapter 14—EDGE Setup and Measurement

14-1	Setting Up the Power Meter for EDGE Measurements	14-1
------	--	------

Chapter 15—WLAN Setup and Measurement

15-1	Setting Up the Power Meter for WLAN Measurements	15-1
------	--	------

Table of Contents (Continued)

15-2	802.11b, a, and g	15-1
Chapter 16—Radar Setup and Measurement		
16-1	Setting Up the Power Meter for Radar Measurements	16-1
Chapter 17—OFDM Setup and Measurement		
17-1	Setting up Continuous OFDM Measurements	17-1
Chapter 18—Examples of Dual Display Operation		
18-1	Changing Display Units	18-1
18-2	Changing Display Modes	18-2
Chapter 19—Dual Sensor Operation		
19-1	Displaying Measurements from Two Sensors Simultaneously	19-1
Chapter 20—Secure Mode		
20-1	Types of Memory	20-1
20-2	Secure Mode	20-1
20-3	Clearing the Non-Volatile Static RAM	20-1
20-4	Anritsu Power Sensors EEPROM	20-2
20-5	EEPROM Contents	20-2
Appendix A—PowerMax Software		
Appendix B—Command Hierarchies		
B-1	Channel - Set Up (Pulsed/Modulated)	B-2
B-2	Channel - Set Up (CW)	B-3
B-3	Channel - Trigger - Trigger Source	B-3
B-4	Channel - Trigger - Set Capture Time	B-4
B-5	Channel - Trigger - Set Trigger Delay	B-4
B-6	Channel - Trigger - Trigger Level	B-5
B-7	Channel - Trigger - Trigger Bandwidth (ML249xA only)	B-5
B-8	Channel - Trigger - More - Arming	B-6
B-9	Channel - Trigger - More - Set Sample Rate	B-7
B-10	Channel - Trigger - More - Trigger Indication	B-8
B-11	Channel - Gating - Set Up (Pulsed/Modulated)	B-9
B-12	Channel - Gating (Cont) (Pulsed/Modulated)	B-9
B-13	Channel - Relative Meas (CW)	B-10
B-14	Channel - Averaging - Set Avg Number (Pulsed/Modulated)	B-10
B-15	Channel - Averaging - Set Avg Number (CW)	B-10
B-16	Channel - Markers - Position Act Mkr (Profile)	B-11

Table of Contents (Continued)

B-17	Channel - Markers - Assign Act Mkr (Profile)	B-11
B-18	Channel - Markers - Delta Marker - Position Delta Mkr (Profile)	B-12
B-19	Channel - Markers - Set Up (Profile)	B-13
B-20	Channel - Markers - Marker Functions - Advanced Functions (Profile) . . .	B-14
B-21	Channel - Duty Cycle (CW)	B-14
B-22	Channel - More - Limit Checking - Set Up (Pulsed/Modulated)	B-15
B-23	Channel - More - Limit Checking - Edit Limit Spec - Select Spec	B-16
B-24	Channel - More - Limit Checking - Edit Limit Spec - Save Spec	B-17
B-25	Channel - More - Limit Checking - Edit Limit Spec - Edit Segments	B-18
B-26	Channel - More - Limit Checking - Edit Limit Spec - Edit Title.	B-19
B-27	Channel - More -Scaling (Profile)	B-20
B-28	Channel - More - Profile Display (Profile)	B-20
B-29	Channel - More - Peaking Indicator (Pulsed/Modulated).	B-21
B-30	Channel - More - Peaking Indicator (CW)	B-21
B-31	Channel - More - Post Process - Set Up	B-22
B-32	Channel - More - Post Process - Cursor.	B-23
B-33	Sensor - Setup.	B-23
B-34	Sensor - Cal Factor.	B-24
B-35	Sensor - Offset.	B-25
B-36	Sensor - Edit Tables	B-26
B-37	Sensor - Edit Tables - Edit Identity	B-27
B-38	Sensor - Edit Tables - Edit Offset Table	B-28
B-39	Cal/Zero	B-29
B-40	System - Save / Recall	B-30
B-41	System - Recall Settings.	B-31
B-42	System - Config - Display - Set Screen Title	B-31
B-43	System - Config - Display - Backlight	B-32
B-44	System - Config - Remote - Set RS232 Baud Rate	B-32
B-45	System - Config - Rear Panel Config.	B-33
B-46	System - Config - Set Inc/Dec Steps	B-34
B-47	System - Service - Identity	B-34
B-48	System - Service - Diag	B-35
B-49	System - Service - Upgrade.	B-35
B-50	Preset	B-36

Table of Contents (Continued)

Appendix C—Default Values and Presets

Appendix D—ML2400A Reference Table

Appendix E—Terminology Glossary

E-1	Terminology Glossary	E-1
-----	----------------------------	-----

Appendix F—Technical Support

Appendix G—Uncertainty Information

G-1	Uncertainty Examples	G-1
-----	----------------------------	-----

Appendix H—Frequently Asked Questions

Appendix I—Connector Care and Handling

I-1	Pin Depth Mating Connectors	I-1
I-2	Torquing Connectors	I-2
I-3	Mechanical Shock	I-2
I-4	Cleaning Connectors	I-3

Chapter 1 — General Information

1-1 About this Manual

This manual provides set-up and operational information for the ML2487B / ML2488B and ML2495A / ML2496A Peak Power Meters. Explanations in this manual apply equally to all instruments mentioned above unless otherwise stated.

The structure of this manual is designed to reflect the sequence of steps that the user will go through after receiving the unit: from unpacking and initial inspection, through setup, and to testing.

1-2 Associated Documentation and Software

Updated software and related literature can be downloaded from the Anritsu website product page Library tab:

<https://www.anritsu.com/en-us/test-measurement/products/ml2487b>

<https://www.anritsu.com/en-us/test-measurement/products/ml2488b>

<https://www.anritsu.com/en-us/test-measurement/products/ml2495a>

<https://www.anritsu.com/en-us/test-measurement/products/ml2496a>

Firmware Versions

Please check the Anritsu website for the latest version of instrument firmware. Some of the features documented in this manual may not be available to users of earlier firmware versions. To check the version of the firmware that you are using, power up the instrument and press **System** > [Service] > [Identity]. Details of how to upgrade the software can be found in [Section 8-17 “Upgrading the System Software”](#).

1-3 Conventions

The following conventions have been adopted in this manual.

Table 1-1. Notation Conventions

Item	Convention
Channel	The six hard keys on the unit are displayed in bold in Arial font.
[Set Up]	Soft keys that display on the screen are enclosed in square brackets. Pressing a soft key provides access to menu options, toggles selections and allows data entry.
[Exit]	Text that appears on or beneath the keys on the numeric keypad is enclosed in square brackets.
[Channel Set Up]	The titles of input dialogs that appear on the screen are enclosed in square brackets.
"Meas display"	Items or text that display within the main body of the screen are enclosed in quotation marks.
ML248xB	Used throughout this manual to refer to both the ML2487B and the ML2488B power meters.
ML249xA	Used throughout this manual to refer to both the ML2495A and the ML2496A power meters.
>	A chevron (>) may be used to indicate that the user should select the items or keys in sequential order.

1-4 Performance Verification

The performance of the power meter's individual signal channel inputs can be verified using an Anritsu Range Calibrator. Contact your Anritsu Customer Service representative for more information.

Chapter 2 — Product Overview

2-1 Overview

The ML248xB / ML249xA is a wideband peak power meter for the 3G and radar pulse measurement market. It is the ideal product for performing accurate measurements on pulsed and modulated systems.



Figure 2-1. ML2496A

2-2 Model Types

Four models of the peak power meter are available:

- ML2487B: Single input peak power meter (20 MHz bandwidth)
- ML2488B: Dual input peak power meter (20 MHz bandwidth)
- ML2495A: Single input peak power meter (65 MHz bandwidth)
- ML2496A: Dual input peak power meter (65 MHz bandwidth)

2-3 Features

Ease of operability

Both the ML248xB and ML249xA incorporate a host of features to make setup and operation as simple as possible. There are predefined and configurable presets, 20 settings stores, multiple independently or repeated gates, 4 independent markers for denoting points of interest on the profile, and user configurable templates.

Dual channel display

Both the ML248xB and ML249xA support dual display channels. Each display channel is a measurement set up and can use any selection or combination of the sensor inputs. The instrument can be configured to view one display channel or two and can be switched between display channels quickly and simply via the **CH1/CH2** hard key on the front panel.

Large colour display with graphical MMI

The quarter VGA high-resolution color display is ideal for profiling and other complex sequences.

Video output

The ML248xB and ML249xA have a video connector on the rear panel as standard and can be connected to a standard VGA monitor. The power meter can be located remotely in a test rack and the video screen located close to where the adjustments are taking place.

Enhanced Measurement Bandwidth

On the ML248xB, the 20 MHz bandwidth is ideal for accurate WLAN, WCDMA and Radar measurements, and removes the need for post-measurement accuracy calculations. On the ML249xA, the mainframe has 65 MHz bandwidth that is wide enough for accurate rise time measurements on radar signals, or for measuring the peak signal of the latest 4G OFDM signals. The ML249xA settable resolution on time based measurements from 50 ns to 3.2 μ s is 1 ns

Two sampling modes

For time durations up to 3.2 μ s, the ML249xA has a continuous sample rate. This can be set either automatically or the sample rate can be adjusted directly by the user. For time durations of 50 ns to 3.2 μ s the power meter uses random repetitive sampling to build up the trace to 1 ns settable display resolution. Changeover between these two modes is performed automatically.

High speed sampling

Sampling of up to 64 MS/s (ML248xB / ML249xA) is ideal for WCDMA, Radar, EDGE, and WLAN measurements.

Compatibility

The power meter is compatible with all MA2400A/B sensors used on the existing Anritsu power meter range.

Remote interface

The ML248xB and ML249xA support both the GPIB and RS232 interfaces, the ML249xA also supports Ethernet, GPIB, and RS232 interfaces.

Secure mode

The power meter has a secure mode for operations in security sensitive areas. Once activated, the secure mode erases all information stored in the non volatile RAM on power up.

2-4 Available Options, Accessories, and Power Sensors

Refer to the Anritsu *Power Meters & Power Sensors Technical Data Sheet*, PN: 11410-00423 for a complete listing of additional options and accessories, including power sensors available for the ML243xA power meters.

2-5 Associated Products

Power Meter (Universal) ML243xA series

The ML2430A series Power Meters combine the advantages of thermal meter accuracy, diode meter speed, and peak power meter display graphics. The result is a single instrument that achieves 90 dB dynamic range with a single sensor. The ML2430A-series includes graphics display capability as a standard feature. The rugged housing and optional, high-capacity NiMH battery bring convenience and accuracy to field service applications.

MS268xA Series Spectrum Analyzer

The MS268x is a high-performance Portable Spectrum Analyses Family with wide dynamic range, wide Resolution Band width and high sweep speeds required for evaluation of next-generation (IMT-2000) broadband mobile communications systems and devices.

Chapter 3 — Assembly and Connections

3-1 Initial Inspection

Inspect the shipping container for damage. If the container or cushioning material is damaged, retain until the contents of the shipment have been checked against the list of shipped items and the instrument has been checked for mechanical and electrical operation.

If the power meter is damaged mechanically, notify your local sales representative or Anritsu Customer Service Center. If either the shipping container is damaged or the cushioning material shows signs of stress, notify the carrier as well as Anritsu. Retain the shipping materials for the carrier's inspection.

3-2 Shipped Items

Your ML248xB / ML249xA power meter is shipped with the following items. Check that all listed items are present, and contact Anritsu if they cannot be found.

Table 3-1. Shipped Items

Item	Part number	Quantity supplied
Peak power meter	ML2487B, ML2488B, ML2495A, ML2496A	1
Line power cable	Country dependent: Australia:800-239 UK: 800-428 Japan: 800-583 US: 800-427 EU 800-429	1
Power sensor cable	2000-1537-R	ML2487B / ML2495A: 1 ML2488B / ML2496A: 2

3-3 Storage and Repackaging

Follow the instructions in this section if, for any reason, it is necessary to repackage, store, or ship your power meter.

Preparation for Storage

Prepare the power meter for storage by cleaning the unit and packing it with moisture-absorbing desiccant crystals.

Environmental Requirements

Store the unit in a temperature controlled environment that is maintained between -40 and +70 °C, with a maximum humidity of 90 % at 40 °C, non-condensing.

Preparation for Shipment

1. To provide maximum protection against damage in transit, the power meter should be repackaged in the original shipping container. If this container is no longer available obtain a corrugated cardboard carton with a 125 kg (275 pound) test strength. This carton should have inside dimensions of no less than six inches larger than the instrument dimensions to allow for cushioning.
2. Wrap the instrument to protect the finish.
3. Cushion the instrument on all sides by tightly packing dunnage or urethane foam between the carton and the instrument. Provide at least three inches of dunnage on all sides.
4. Seal the carton using either shipping tape or an industrial stapler.
5. If the instrument is being returned to Anritsu for service, mark the address of the appropriate Anritsu service center (refer to <http://www.anritsu.com>), the Return Materials Authorization (RMA) number, and your return address on the carton in a prominent location.

3-4 Rack Mounting

The ML248xB / ML249xA can be ordered with rack mounting hardware that allows the instrument to be mounted into a standard 19-inch equipment rack. There are two rack mount option kits available:

- The 2400-82 Rack Mount option allows the installation of a single ML248xB / ML249xA in either the left or right side rack position.
- The 2400-83 Rack Mount option allows side-by-side mounting of two ML248xB / ML249xA Test Sets.

Caution

The ML248xB / ML249xA is cooled by a fan at the rear that circulates air around the instrument through vent holes in the base. The fan and vent holes should not be blocked, either when used as a stand-alone instrument or when mounted in an instrument rack as detailed below.

Refer to the installation instructions supplied with the rack mounting kit.

3-5 Power Requirements

The ML248xB / ML249xA Power Meter is operated from an AC power line. The Power Meter is intended as an Installation (Overvoltage) Category II, Insulation Category I device.

At power-on, the power meter will perform a brief power-on self test (POST). If a POST error occurs, information and available options will be displayed on the screen. If the POST is successful, the instrument will load the last used configuration.

Note	If "Secure" mode has been enabled, certain stored values will be cleared when the instrument is switched on.
-------------	--

AC Line Power

The ML248xB / ML249xA Power Meter can operate on AC input power of 85-264V, 47-440 Hz, 80 VA maximum. The Power Meter automatically configures itself for the voltage applied. The AC line input is protected by an internal fuse.

Fuses

The AC input lines are protected by an internally mounted fuse. This fuse should only be changed by qualified service personnel. Replace only with a fuse of the same type and rating (AC fuse, 2A, 250V, slow-blow).

Grounding

The ML248xB / ML249xA Power Meter must be properly grounded. Failure to ground the instrument could be hazardous to operating personnel. The meter is supplied with a three-conductor power cord. The instrument is properly grounded during AC line operation when the plug is connected to a properly installed three-prong receptacle.

Environmental Requirements

The ML248xB / ML249xA Power Meter is designed to operate within the temperature range of 0 to 50 °C (32 to 122 °F) with a maximum humidity of 90 % at 40 °C (104 °F), non-condensing. Full accuracy is dependent upon the sensor specification. Refer to the sensor manual for details.

3-6 Rear Panel Connections

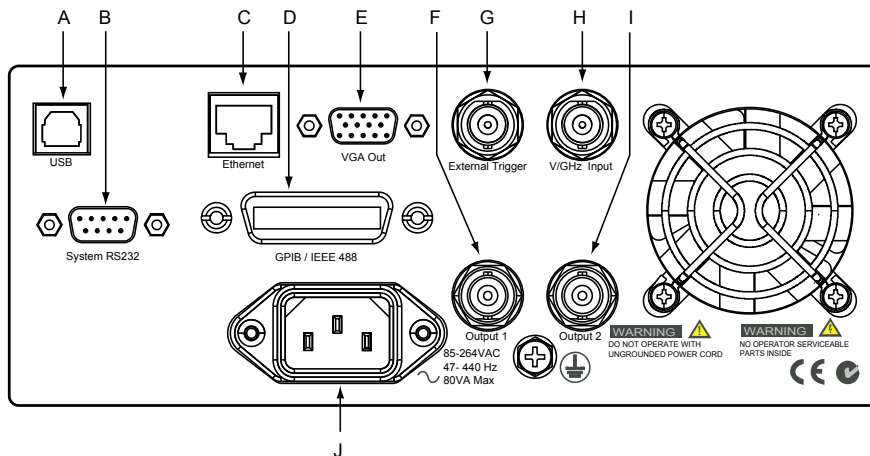

Figure 3-1. Rear Panel

Table 3-2. Rear Panel Connectors

Key	Item
A	USB connector: Not currently implemented.
B	RS232 serial connector: Serial control and data output commands are entered using the same format as the GPIB interface.
C	Ethernet - 10/100 Base T LAN Interface.
D	GPIB / IEEE488 connector: Standard General Purpose Interface Bus connector used to connect through GPIB to other test equipment and a host computer.
E	VGA Out: For video output to 1/4 VGA external display.
F	Output 1: Multi-purpose BNC connector is user configurable for Analog Output 1 (volts/units), or Limits Pass/fail (TTL). Supports pass/fail testing for channel 1. Also configurable to output a real-time measurement signal from sensor input A, suitable for levelling purposes.
G	Input 1 (Digital): Multi-purpose BNC connector used as a TTL Trigger Input.
H	Input 2 (Analog): Multi-purpose BNC connector used for Volts per GHz connection. Supports 0 to + 20 V nominal input voltage with software selectable scaling. V/GHz is used for automatic CAL FACTOR correction by applying an external voltage, scaled to frequency. The correct calibration factor for this frequency is automatically interpolated and applied when in V/GHz calibration factor mode. Different scaling may be applied to sensor A or B, allowing for measurement of frequency translation devices. Available simultaneously with channel A and/or B data, the data rate is as set on the channel. Also used for PAE measurements using a current probe.
I	Output 2: Multi-purpose BNC connector is user configurable for Analog Output 2 (volts/units), or Limits Pass/fail (TTL). Supports pass/fail testing for channel 2. Also configurable to output a real-time measurement signal from sensor input B, suitable for levelling purposes. Also supports trigger out.
J	AC main power input: 85-264 VAC, 47- 440 Hz, 80 VA maximum. Connecting the AC power puts the instrument into standby mode.

Chapter 4 — Front Panel Layout and Operation

Before attempting to use the ML248xB / ML249xA it is first necessary to understand the layout and basic operation of the front panel. This chapter presents several detailed illustrations of the front panel and explains the operation of each of the component sections in turn.

It is recommended that you read through this chapter whilst identifying each of the component sections and performing the procedures detailed on your power meter. First, follow the procedure below to power on the ML248xB / ML249xA.

4-1 Power-On Procedure

1. Ensure that all the required power meter connections have been made as specified in the previous chapter.
2. Press the [On/Standby] button on the numerical keypad.
3. At power-on, the power meter performs a brief power-on self test (POST). After the POST, the instrument loads the most recently used configuration and display settings.
4. If a POST error occurs, information and available options are displayed on the screen. Press the **Clr** hard key to display the main command menu.

4-2 The Front Panel

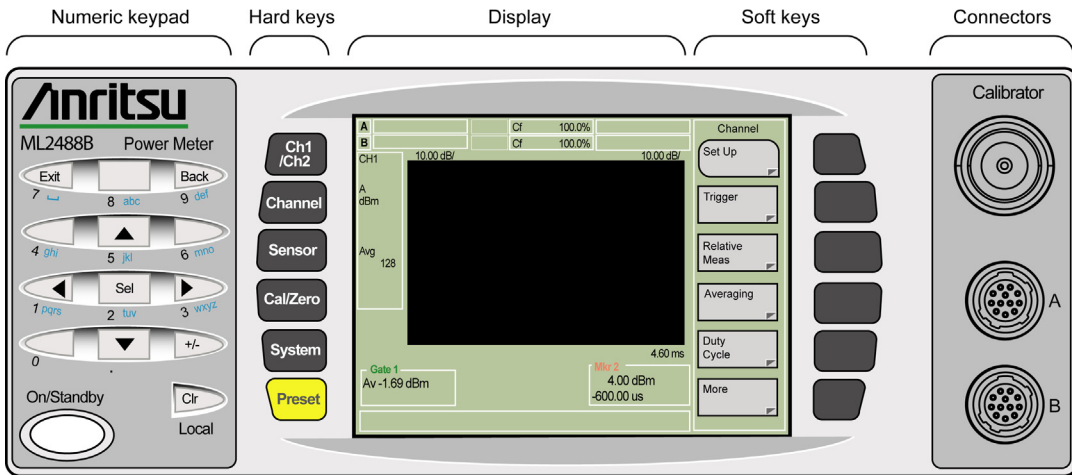

Figure 4-1. Front Panel

Note

The illustration above shows the front panel of the ML2488B. With the exception of the model number itself, the front panel of the ML2496A is also identical. The ML2487B and ML2495A models have only one sensor connector.

4-3 The Numeric Keypad

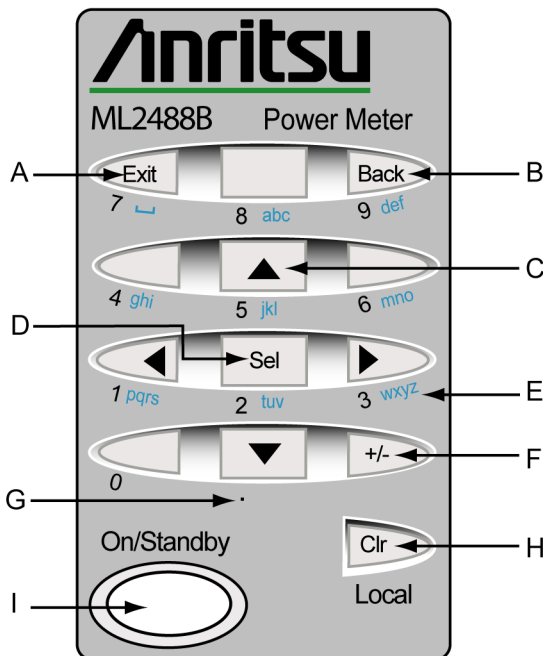

Figure 4-2. Numeric Keypad

Table 4-1. Numeric Keypad

Item	Description
A	[Exit] The [Exit] key is used to close a pop-up dialog and revert to the previous page of commands. Pressing this key when a field in a dialog has been selected for user input will result in entry of the number "7" or the entry of a space if the field is non-numeric.
B	[Back] The [Back] key is used to revert to the previous page of commands. Pressing this key when a field in a dialog has been selected for user input will result in entry of the number "9" or the entry of the letter "d" if the field is non-numeric.
C	Arrows The arrow keys to the top and bottom of the center [Sel] key are used to move vertically between the entry fields in a dialog. The right and left arrows can be used to jump between columns in tables that display within a dialog. The arrow keys can also be used to reposition the active marker.
D	[Sel] The [Sel] key is used to enable an entry field for input by the user. When the [Sel] key is pressed, the field is highlighted in white and a number of underscores are used to indicate the maximum length of permissible entry. Pressing this key when a field in a dialog has been selected for user input will result in entry of the number "2" or the entry of the letter "t, u, v" if the field is non-numeric.

Table 4-1. Numeric Keypad

Item	Description
E	A number and a series of letters appear beneath most of the keys on the numeric keypad. These can be used when an entry field has been selected for user input using the [Sel] key. Refer to the example of text input later in this chapter.
F	[+/-] Used to enter a "+" or "-" symbol in a numerical entry field.
G	Decimal point Used to enter a decimal point in certain fields for numeric entry.
H	[Clr] / Local The [Clr] key is used in a user entry field to delete the letter or number that was last entered. It is also used to revert the unit from remote to local operation.
I	[On/Standby] Used to turn the power meter on and off once the main AC power has been supplied.

4-4 The Hard Keys

The hard keys are used to display the associated soft key commands. When a hard key is pressed the commands within that group display next to the soft keys at the right of the screen. The menu items are grouped in to a logical hierarchical structure, a full mapping of which is provided in appendix A at the rear of this manual. When a hard key is pressed, the name of that key displays at the top of the soft key menu. An overview of each of the hard keys is provided below.



Used to change the currently active channel. The menu displayed in the menu area is updated to reflect the state of the new active measurement channel.



Controls channel related functions such as display channel set up, triggering, gating, averaging, and markers.



Controls sensor related function such as cal factor settings and offsets.



Enables measurement errors to be minimized prior to measurement, and sensors to be zeroed and/or calibrated.



Controls system level commands such as the rear panel configuration, security, and software upgrading.



Allows the user to select and configure predefined configuration and default settings.

4-5 The Screen

The screen on the ML248xB / ML249xA can be sub-divided into several sections, each of which is illustrated and explained below.

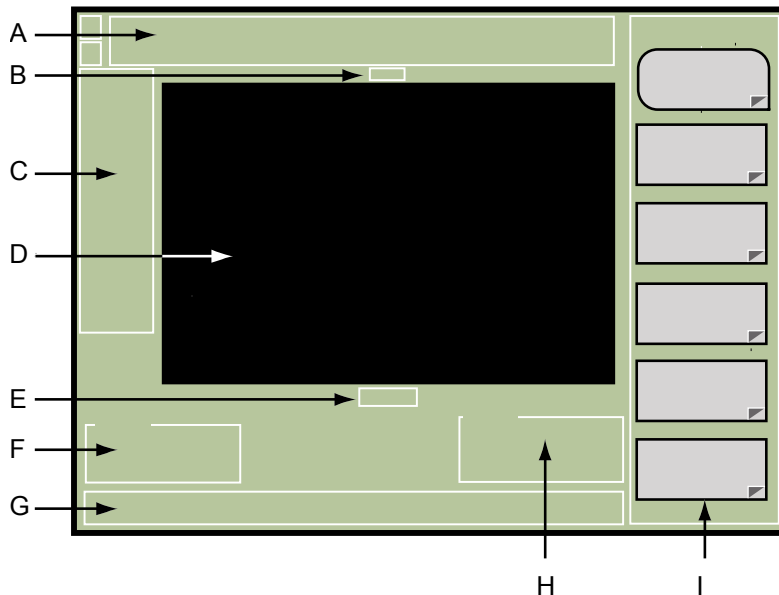

Figure 4-3. Screen Sub-divisions

Table 4-2. Description of Screen Sub-divisions

Item	Description
A	Sensor related information.
B	Profile display icon.
C	Channel related information.
D	Area for profile and readout displays.
E	Sample rate display.
F	Gating and statistics related information.
G	Status bar for error message and status reports.
H	Marker and cursor related information.
I	Soft key commands.

Note

The figure above represents the screen when the measurement display setting is set to "Profile". When viewed in "Readout" mode, sections B, E, F, and H are not displayed. Refer to "Selecting the Measurement Display Style" in chapter 5 of this manual.

4-6 Sensor Information

Sensor related information displays at the top of the screen (section A in the figure on the previous page). On the ML2487B / ML2495A there is one line of sensor information, and on the ML2488B / ML2496A, a second line is added beneath for sensor input B.

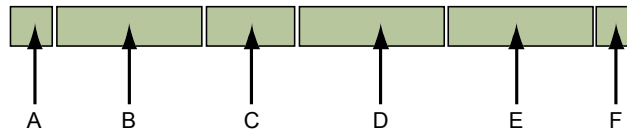

Figure 4-4. Sensor Information

Table 4-3. Description of Sensor Information

Item	Description
A	Sensor input letter Displays the letter (either A or B) of the associated sensor input.
B	Sensor model Displays the model number of the sensor connected to the input.
C	Measurement option Information is displayed in this section if a Universal sensor with option 1 is connected to the input. If the user has selected the Fast CW measurement option, 'F-CW' displays, otherwise 'T RMS' displays for the True RMS measurement option.
D	Cal factor information Displays the source and value of the calibration factor being applied to the sensor. The following abbreviations are used to indicated the source of the cal. Factor: "Cf" Frequency - the calibration factor is derived from the cal factor table using the input signal frequency. "Cm" Manual - the user has set the calibration factor value. "Cv" V/GHz - the calibration factor is derived from the cal factor table using the frequency value that is proportional to the voltage on the rear panel input.
E	Offset information The type of the offset and its value are displayed. The following abbreviations are used to indicate the type of offset: "Of" Fixed - the user has set the offset value. "Ot" Table - the offset value is derived from the selected offset table.
F	Held range information Information is displayed if the current sensor input is being held to a single operating range.

4-7 Channel Information

Channel related information displays at the left of the screen (section C in the main screen overview figure).

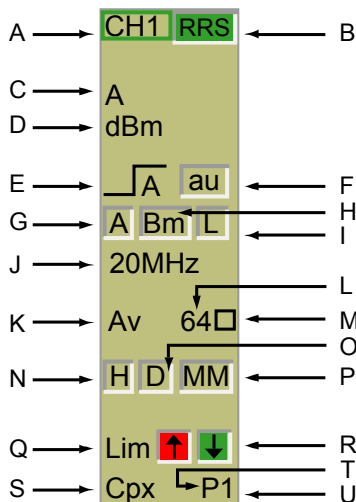

Figure 4-5. Channel Information

Table 4-4. Description of Channel Information

Item	Description
A	Channel ID (Ch1/ Ch2) Used to identify the channel being displayed on the screen.
B	RRS mode flag (Channel > [Trigger] > [Set Cap Time] > Enter value <3.19 s) (ML249xA only) "RRS" (red): RRS measurement incomplete. "RRS" (green): RRS measurement complete. Blank space: Non-RRS measurement.
C	Input configuration (Channel > [Set Up] > "Input Config") Displays the input (or input combination) being used to derive the measurements
D	Measurement units (Channel > [Set Up] > "Units") Displays the units that the measurement is being displayed in.

Table 4-4. Description of Channel Information







Item	Description
E	<p>Trigger status (Channel > [Trigger] > [Trigger Source])</p> <p>The first section of the trigger status icon conveys the settings at the "Source" and "Type" items in the [Trigger Set Up] dialog.</p> <p> External trigger, rising edge</p> <p> External trigger, falling edge</p> <p> Internal trigger, input A, rising edge</p> <p> Internal trigger, input A, falling edge</p> <p> Internal trigger, input B, rising edge</p> <p> Internal trigger, input B, falling edge</p> <p> Continuous</p>
F	<p>Auto Trigger indicator (Channel > [Trigger] > [Trigger Level] > [Auto Trigger])</p> <p>"au": Auto triggering on.</p> <p>Blank space: Auto triggering off.</p>
G	<p>Arming type flag (Channel > [Trigger] > [More] > [Arming])</p> <p>"A": Automatic</p> <p>"S": Single</p> <p>"F": Frame</p>
H	<p>Trigger bandwidth flag (Channel > [Trigger] > [Trigger Bandwidth])</p> <p>"Ba": Automatic selection of bandwidth</p> <p>"Bm": User selected bandwidth</p>
I	<p>Linked triggers flag (Channel > [Trigger] > [More] > [Link])</p> <p>"L": Triggers are linked.</p> <p>Blank space: Triggers are not linked.</p>
J	<p>Trigger bandwidth value (Channel > Trigger > Trigger Bandwidth)</p>
K	<p>Averaging mode ([CW mode] > Channel > [Averaging])</p> <p>Blank line: Averaging is off (CW & pulsed / modulated)</p> <p>"Av": Auto averaging (CW) Averaging on (pulsed / modulated)</p> <p>"Am": Moving averaging (CW)</p> <p>"Ar" Repeat averaging (CW)</p>
L	<p>Number of averages (Channel > [Averaging] > [Set Avg Number])</p>
M	<p>Averaging active indicator (Channel > [Averaging] > [Averaging])</p>
N	<p>Measurement hold flag (Channel > [More] > [Meas Hold])</p> <p>"H": Measurement held</p> <p>"Blank space": Measurement not held</p>

Table 4-4. Description of Channel Information

Item	Description
O	Data hold flag ([Pulsed / modulated mode] > Channel > [More] > [Profile Display] > [Data Hold] > [Infinite]) "D": Data hold on. "Blank space": Data hold off.
P	Min/Max hold flag ([Pulsed / modulated mode] > Channel > [Set Up] > "Measurement" > [Min & Max Hold]) "MM": Min/Max hold on. "Blank space": Min/Max hold off.
Q	Limit checking flag (Channel > [More] > [Limit Checking] > [Limit Checking]) "Lim": Limit checking on. "Blank space": Limit checking off.
R	Upper / Lower limit check status (Channel > [More] > [Limit Checking] > [Set Up] > "Application") Green background: Check passed. Red background: Check failed. Blank space: Check off.
S	Limit checking type (Channel > More > [Limit Checking] > [Set Up] > "Mode") "Simple": Simple limit check being performed. "Cpx": Complex limit check being performed.
T	Complex limit type and number (Channel > [More] > [Limit Checking] > [Set Up] > "Specification") "P": Predefined specification in use. "U": User defined specification in use.
U	Complex limit specification number (Channel > [More] > [Limit Checking] > [Set Up] > "Specification")

4-8 Status Bar

The status bar is used to display status information and error messages. If the instrument is in remote operation, one of the following is displayed at the right end of the status information line.

REM: Indicated that the instrument is in remote operation.

LLOC: Indicates that the instrument is in remote operation with local lockout enabled.

Note Both the REM and the LLOC indicators are displayed if the instrument is in remote operation with local lockout enabled.

4-9 The Soft Keys

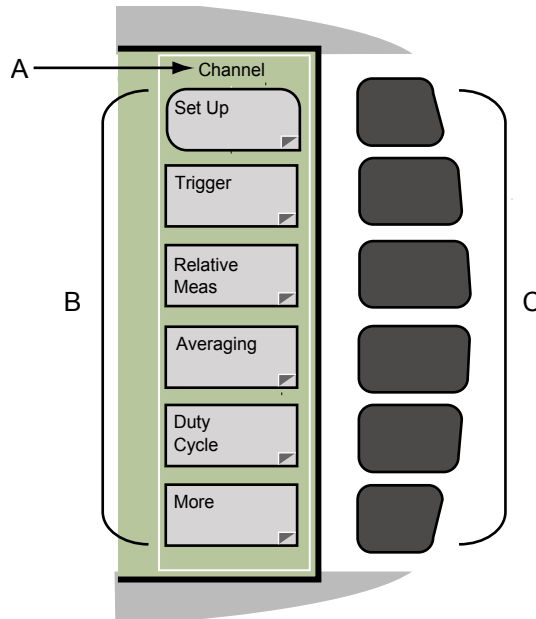

Figure 4-6. Soft Keys

Table 4-5. Description of Soft Keys







Item	Description
A	The title of each menu grouping is shown at the top of the menu area.
B	Each menu set contains a maximum of six commands at any one time, although some may contain only one or two. In the case of the example above, additional commands that could not be displayed on a single page are accessed by pressing the [More] command. The shape of the soft key indicates the type of screen that will display when this key is pressed. Illustrations and descriptions of each type of soft key are provided on the following page.
C	The labelled soft keys themselves cannot be pressed, and instead the corresponding key to the right is pressed to select the command.
	Displays an additional page of soft keys. The fold in the lower right corner indicates to the user that there is more on the following page.
	Displays an additional page of soft keys and an input dialog for the key that was pressed. When entry in the dialog box is complete, the user must then press [Exit].
	Displays a numeric entry field allowing the user to enter a value for the associated parameter. The text displayed on buttons of this type is always followed by three dots (...).

Table 4-5. Description of Soft Keys

Item	Description
	Runs a function with no further user interaction.
	Allows the user to toggle between two choices. The side of the button that appears depressed is the side that is currently active.
	Toggles a parameter between on and off. The green light in the lower right corner indicates that the current state of the parameter is on, active, or true.
	Used to select one of several possible alternatives. The strip on the right side of the button is lit green to indicate the option that is currently selected.

4-10 Dialog Boxes

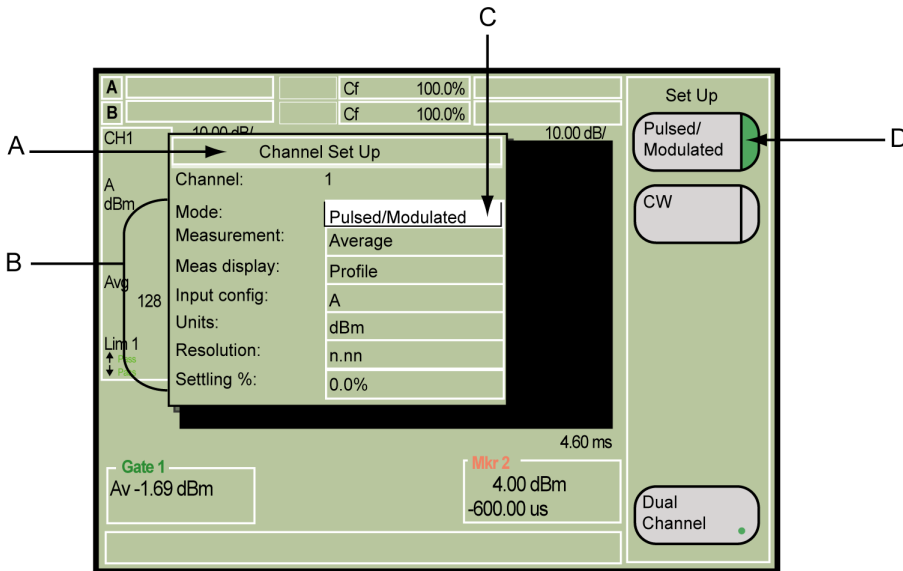

Figure 4-7. Dialog Box

Table 4-6. Description of Dialog Box

Item	Description
A	Dialog title bar.
B	Setting items. The user can move between settings using the up and down arrows on the numerical keypad. Items that are not available for selection are grayed out, and these are skipped over when the user moves up and down the list.
C	The item that is currently selected in an input dialog is highlighted in white. There are two basic types of entry field in dialogs such as the one shown in the figure above. The first type is one in which, once the item is selected, the required setting is selected from the soft keys that display to the right. In the example above, all the fields apart from "Settling %" are of this type. The second type of entry field is for numeric or alphabetic entry, and an example of this can be seen at the "Settling %" item in the dialog above. Entry into a field of this type is made by at the numerical keypad by pressing [Sel], entering the required value, and then pressing a soft key to enter the value or select the units of measurement.
D	The soft keys that display in the menu area change to display the commands for the entry field in the dialog that is currently selected. In the case of the example above, the "Mode" entry field is selected and the green stripe on the [Pulsed/Modulated] soft key indicates that this is the setting that is currently selected.

Note Dialogs are closed by pressing either the [Exit] key on the keypad, or by selecting any of the hard keys except **Ch1/Ch2** when the dialog in question is a channel related one.

4-11 The Connectors

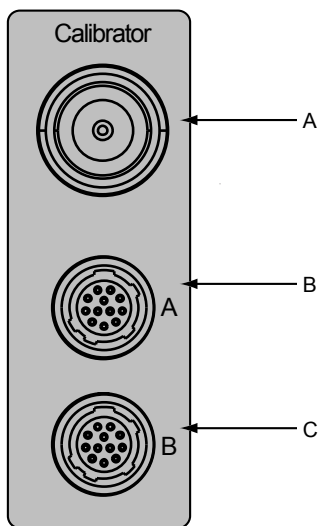

Figure 4-8. Front Panel Connectors

Table 4-7. Description of Connectors

Item	Description
A	<p>Calibrator Reference</p> <p>This connector is a precision female N- Type, 50 Ohm connector that provides a precision, traceable 0.0 dBm, 50 MHz or 1 GHz reference signal for absolute calibration of the sensors. (The 1 GHz signal is standard on the ML249xA, and available as an option for the ML248xB.) The calibration signal can be turned on or off through the Cal/Zero menu. As an option, the calibrator reference can be positioned on the rear panel, either in combination with sensor A connector (option 7), or with both the A and B connectors (option 8).</p>
B	<p>Sensor A connector</p> <p>This connector is a 12- pin circular precision connector to be used in conjunction with power sensor cables. An optional rear panel Channel A connector is offered as an alternative. If the rear panel connector option is installed, the front panel connector is not installed.</p>
C	<p>Sensor B connector</p> <p>This connector is a 12- pin circular precision connector to be used in conjunction with power sensor cables. An optional rear panel Channel B connector is offered as an alternative. If the rear panel connector option is installed, the front panel connector is not installed.</p>

4-12 Data Entry Procedure

Numeric Entry Example

The steps below serve as an example of how to enter a numeric value. Follow the steps carefully until you become familiar with the procedure.

1. Press the **Channel** hard key followed by the [Set Up] soft key.
2. A user entry dialog opens with the "Mode" entry field already highlighted and set to "Pulsed/Modulated". The soft keys to the right of the dialog indicate that this is a selection type entry field, and that the setting can be changed by pressing the soft keys available. In this case, there are two choices [Pulsed/Modulated] and [CW], and as these are pressed, the entry in the "Mode" field changes accordingly. For the purposes of this explanation, select [Pulsed/Modulated]. As described earlier in this section, a green strip on the right of the soft button indicates the parameter that is currently selected.
3. Press the down arrow on the numeric keypad to move the cursor down to "Settling %".
4. Press the center [Sel] key on the numeric keypad. The current setting in the "Settling %" entry field is now replaced with a number of underscores. The number of underscores indicates the number of digits that can be entered in this field.

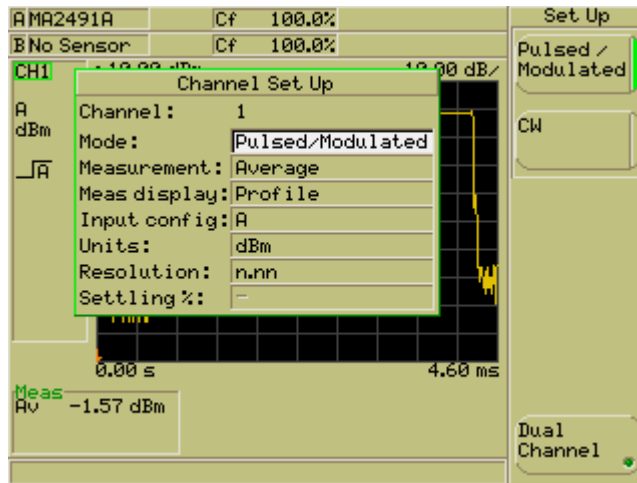

Figure 4-9. [Channel Set Up] Dialog

5. Enter a value from the numeric keypad. If a digit is entered by mistake, use the [Clr] to delete the digit last entered.
6. When entry is complete, press the [Enter] soft key to enter the value. The arrow keys on the numeric keypad can now be used to move the cursor to the next field if further entry is required.
7. If there is nothing further to enter, press the [Exit] key to save the settings and revert to the previous page in the command hierarchy.

Text Entry

1. On selection of the text entry field using the [Sel] key, the current contents of the field are cleared and replaced by a number of underscores, '_', indicating the number of characters that may be entered.
2. Text can now be entered from the numeric keypad. Beneath each of the buttons on the keypad there are three, or in some cases four, letters. The first press of a key enters the first of the letters associated with it. Subsequent immediate presses replace that letter with the second, third, or fourth letter.
3. In some places, such as the dialog to enter the screen title, there is a [Next] soft key that displays after pressing the [Sel] key. The [Next] key is used to input consecutive letters that are both entered from the same key on the keypad. For example, to enter the word "EDGE", the user would press the "def" key twice to enter the "e", press the [Next] soft key, and then press the "def" key again to enter the following "d".
4. If a mistake is made, use the [Clr] key to delete the last entered character. If the field is empty when [Clr] is pressed, text entry will be terminated. Pressing the [Enter] soft key when the field is empty also terminates text entry and in both cases, the previous value of the field is restored.
5. Press the [Enter] soft key when data entry is complete.

Power-Off Procedure

Press the [On/Standby] button to turn off the ML248xB / ML249xA at any point during operation. Changes made to any of the settings prior to the point when the power was cut are saved automatically.

Chapter 5 — Channel Menu Reference

5-1 Understanding and Setting Up the Channels

The ML248xB / ML249xA has either single or dual sensor inputs, two channels, two modes, and two measurement display options, and before explaining how these are set up, it is first important to ensure that the meanings and uses are fully understood.

Sensor Inputs

The sensor inputs are the physical connectors on the front panel to which the sensors are attached. The ML2488B and ML2496A have two sensor inputs, labelled A and B, and the ML2487B and ML2495A have one.

Channels

Both the ML248xB and the ML249xA have two display channels; 1 and 2, each of which may be configured to measure a signal from either a CW or pulsed/modulated source, and each of which may display the results in either a profile (graphical) or readout form. The channels can also be configured for any of the available sensor inputs. To allow each channel to be set up as required, the power meter employs the concept of the "active channel". The active channel can be changed at any time by pressing the **Ch1/Ch2** hard key.

Modes

There are two modes available; "Pulsed/Modulated" and Continuous Wave ("CW"), and both of the channels can be set up for either mode.

Table 5-1. Modes of Operation

Mode	Definition
Pulsed/Modulated	Select this mode to measure pulsed or modulated signals. This selects the high-speed data acquisition system to measure the signal. The measurement is made on data captured over a specified time period. This time period can either be set by the user in the gate settings, for example for TDMA or Radar measurements, or can be left at the default setting for applications such as CDMA.
CW	Measurements are made continuously and displayed at a rate determined by the averaging parameters and signal level.

Measurement Displays

There are two measurement displays available; "Readout" and "Profile". The difference between the displays is explained below.

Table 5-2. Measurement Displays

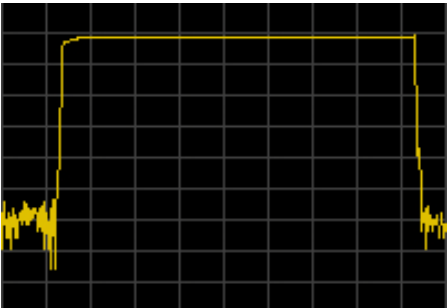
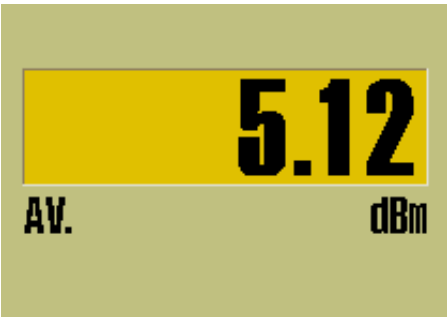
Display	Definition
	<p>Profile:</p> <p>The measurement of the active channel is displayed as a graphical trace to which markers and gating patterns can be added.</p>
	<p>Readout:</p> <p>The measurement of the active channel is displayed as a digital readout. In this mode, a waveform of the signal under test is not shown, but the numeric information is identical to that in Profile mode.</p>

Channel Configuration Overview

The figure below summarizes the information above. It shows that both channels can be configured independently to almost any combination of settings. The information in parentheses shows settings that are not available on the ML2487B or ML2495A, or those that are unavailable due to specific setting combinations. Each of the settings shown in the figure is explained in detail in the following pages.

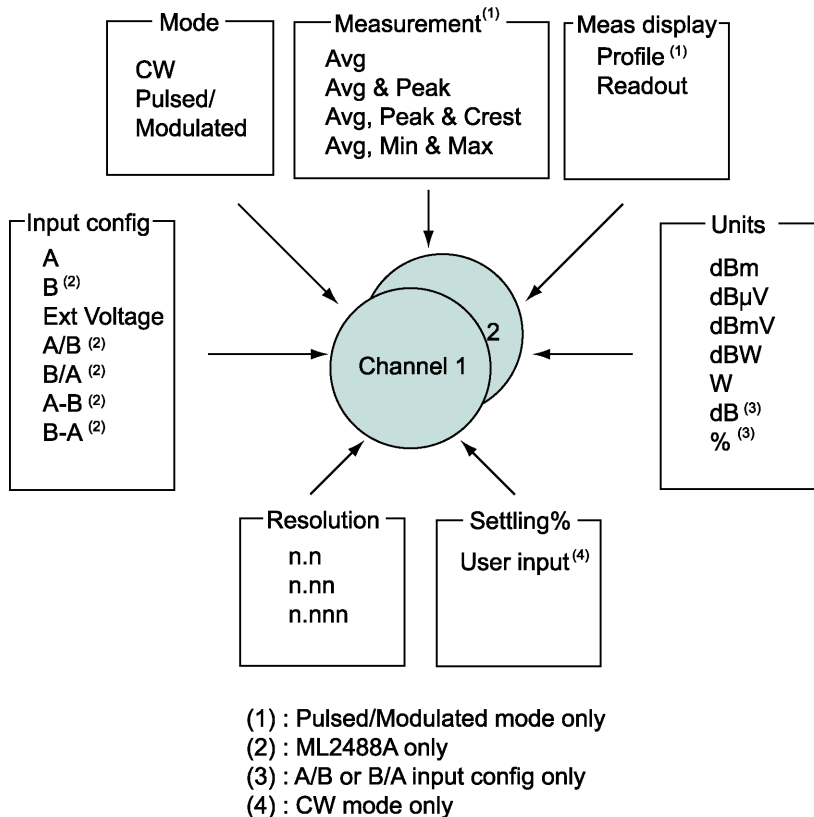

Figure 5-1. Channel Configuration

5-2 Selecting the Measurement Mode

1. Press the **Channel** hard key to display the Channel group of commands.
2. Press the [Set Up] soft key to display the [Channel Set Up] dialog for the channel that is currently active. The dialog will open with the "Mode" item already selected.

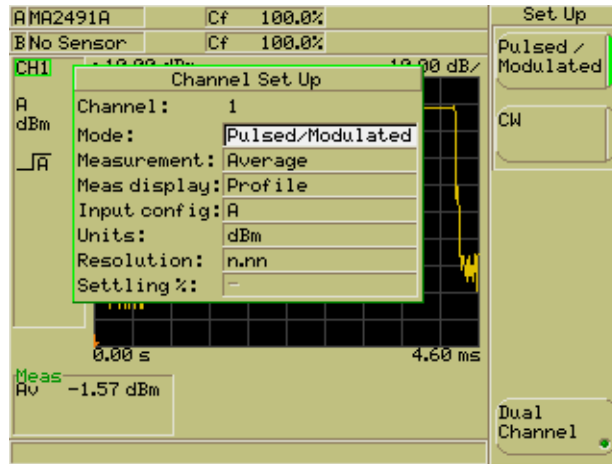

Figure 5-2. Measurement Mode Selection

3. Use the soft keys to select the required mode. There are two options available; "Pulsed/Modulated" or "CW".
4. Use the down arrow on the numerical keypad to select another item in the dialog, or press the [Exit] hard key if no further settings are required.

5-3 Selecting the Measurement Type

1. Press the **Channel** hard key to display the [Channel] group of commands.
2. Press the [Set Up] soft key to display the [Channel Set Up] dialog.

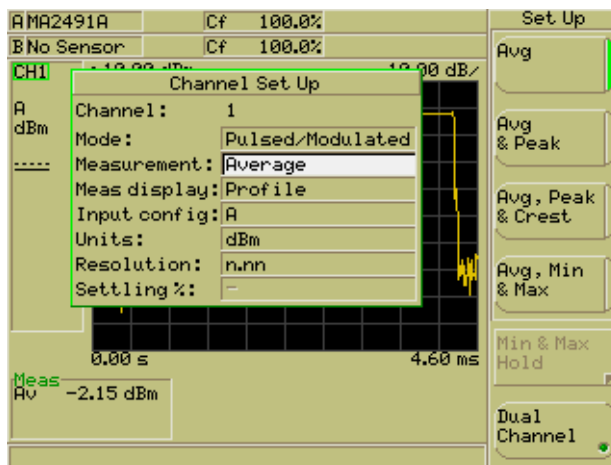

Figure 5-3. Measurement Type

3. Make sure that the "Channel" item in the dialog is displaying the channel for which the settings are required. If the channel is incorrect, press the **Ch1/Ch2** hard key to change the active channel.
4. Press the down arrow on the numeric keypad to select the "Measurement" item and then select the required measurement mode using the soft keys. Refer to the table below.

Table 5-3. Measurement Modes

Item	Meaning
Avg	The ML248xB / ML249xA extracts the average power from each enabled gating pattern or from the data captured during the trigger capture time.
Avg & Peak	The ML248xB / ML249xA extracts the average power, along with the peak power value, from each enabled gating pattern or from the data captured during the trigger capture time.
Avg, Peak & Crest	The ML248xB / ML249xA extracts the average power, along with the peak power value and the crest factor, from each enabled gating pattern or from the data captured during the trigger capture time.
Avg, Min & Max	The ML248xB / ML249xA extracts the average power, along with the minimum and maximum power values, from each enabled gating pattern or from the data captured during the trigger capture time. When averaging is applied, the maximum values are derived from the averaged trace data.

The "Measurement" item is not available in CW mode.

It is important to note the difference between Max and Peak in the settings above. Max represents the highest averaged value acquired over each section of the signal. This Max value can differ to Peak value considerably in that Peak represents the highest value taken from the raw samples. For WCDMA, WLAN, and EDGE measurements, the user is advised to select the Avg, Peak & Crest setting to measure and display the peak value taken from the sampled data itself. For RADAR measurements, the user is advised to select the Avg, Min & Max setting to reduce the effects of peak impulse noise.

5-4 Selecting the Measurement Display Style

1. Press the **Channel** hard key to display the Channel group of commands.
2. Press the [Set Up] soft key to display the [Channel Set Up] dialog for the channel that is currently active.

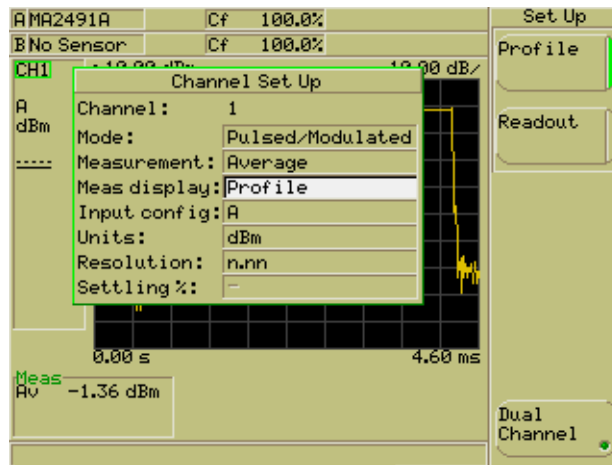

Figure 5-4. Measurement Display

3. Press the down arrow on the numeric keypad to select the "Meas Display" item.
4. Use the soft keys to select the required mode. There are two options available; "Profile" or "Readout", the difference between which is explained earlier in this chapter.
5. Use the down arrow on the numerical keypad to select another item in the dialog, or press the [Exit] hard key if no further settings are required.

Note The "Meas display" item is not available in CW mode.

5-5 Selecting the Sensor Input (ML2488B and ML2496A only)

1. Press the **Channel** hard key to display the Channel group of commands.
2. Press the [Set Up] soft key to display the [Channel Set Up] dialog for the channel that is currently active.

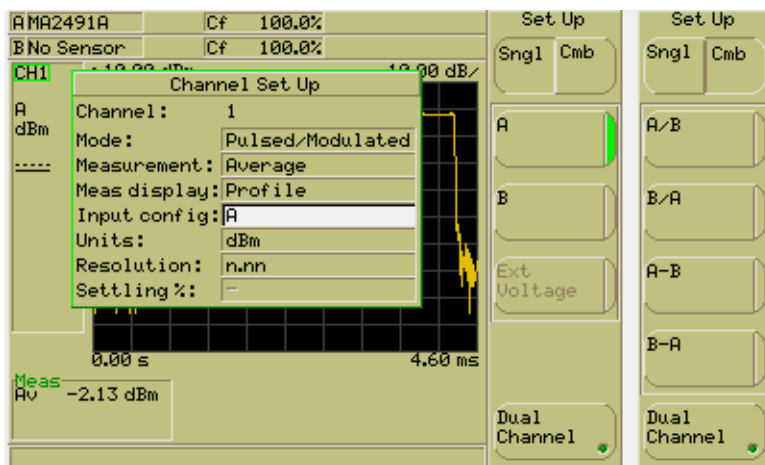

Figure 5-5. Sensor Input

3. Press the down arrow on the numeric keypad to select the "Input config" item.

The uppermost soft key within the [Set Up] menu for input configuration shows that there are two subgroups within this menu; "Sngl" (Single) or "Cmb" (Combined). Single mode is selected by default, and in this mode there is a simple choice between sensor input A, B, or Ext Voltage.

Note The "Ext Voltage" item is not available in Pulsed/Modulated mode.

The "Cmb" (combined) grouping contains further options and in this case a calculation is made between the power values for inputs A and B. Further details of all the input configurations are presented in the table below.

Note For the ML2487B and ML2495A the user can select between sensor input A and Ext Voltage for a CW channel.

Table 5-4. Sensor Inputs

Input	Description
A	Input is taken from sensor A.
B	Input is taken from sensor B.
Ext Voltage	Take input from the rear panel BNC, "Input 2, Analog".

Table 5-4. Sensor Inputs

Input	Description
A/B	Sensor measurement A is divided by sensor measurement B and displayed on the current channel.
B/A	Sensor measurement B is divided by sensor measurement A and displayed on the current channel.
A-B	Sensor measurement B is subtracted from sensor measurement A and displayed on the current channel.
B-A	Sensor measurement A is subtracted from sensor measurement B and displayed on the current channel.

4. Select the required input configuration from either the Sngl or Cmb menus.
5. Use the down arrow on the numerical keypad to select another item in the dialog, or press the [Exit] hard key if no further settings are required.

5-6 Setting the Units of Measurement

1. Press the **Channel** hard key to display the Channel group of commands.
2. Press the [Set Up] soft key to display the [Channel Set Up] dialog for the channel that is currently active.

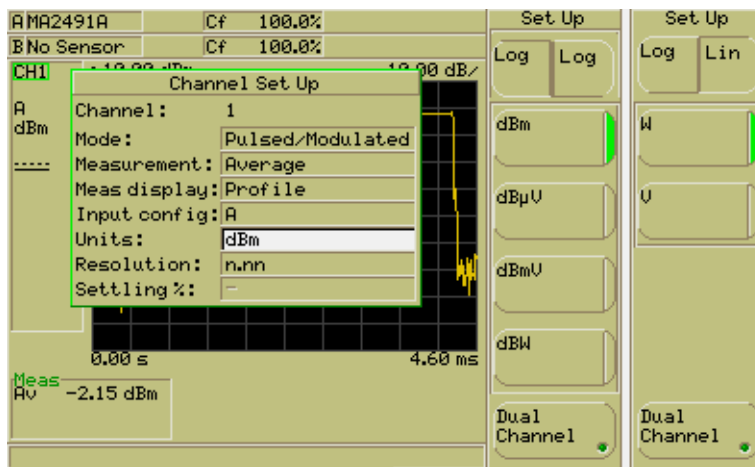

Figure 5-6. Units of Measurement

3. Press the down arrow on the numeric keypad to select the "Units" item.

4. Use the soft keys to select the required unit.

Note The default setting for the ML248xB / ML249xA is to display units in dBm, but this can be changed to any of the other options available.

The figure above shows the units available when the "Input config" item is set to "A", "B", "A-B", or "B-A". When "Input config" is set to "A/B" or "B/A", the units available for selection are "dB" or "%".

5-7 Selecting the Resolution

1. Press the **Channel** hard key to display the Channel group of commands.
2. Press the [Set Up] soft key to display the [Channel Set Up] dialog for the channel that is currently active.

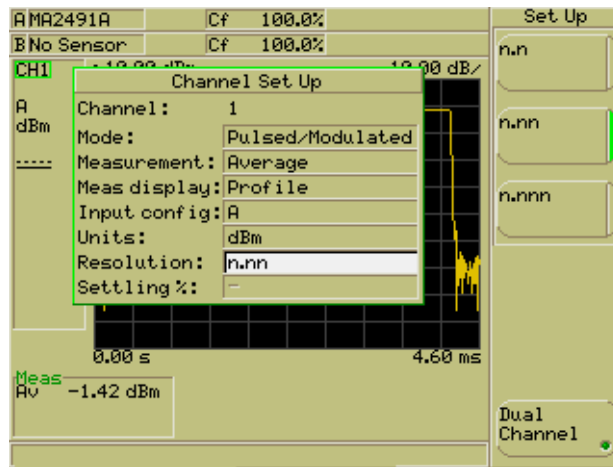

Figure 5-7. Resolution

3. Press the down arrow on the numerical keypad to select "Resolution".
4. Use the soft keys to select the required resolution. The default setting for the ML248xB / ML249xA is to display the resolution to two decimal places (n.nn).
5. Use the arrows on the numerical keypad to select another item in the dialog, or press the [Exit] hard key if no further settings are required.

5-8 Entering the Settling Percentage

The settling value allows some control over the tradeoff between speed and the extent to which a measurement has settled to its final value. A 1% settling time value relates to approximately 0.04 dB.

1. Press the **Channel** hard key to display the Channel group of commands.

2. Press the [Set Up] soft key to display the [Channel Set Up] dialog for the channel that is currently active.

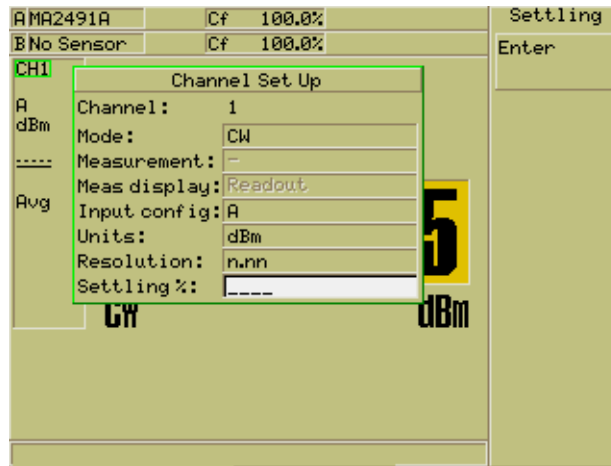

Figure 5-8. Settling Percentage

3. Press the down arrow on the numerical keypad to select "Settling %".
4. Press the [Sel] key and enter the required setting value from the numeric keypad.
5. Press the [Enter] soft key when complete.
6. Use the arrows on the numerical keypad to select another item in the dialog, or press the [Exit] hard key if no further settings are required.

Note The "Settling %" item is only available in CW mode.

5-9 Selecting Dual Display Channel Mode

As explained earlier in this chapter, the ML248xB / ML249xA allows the user to measure power on two channels. There are a number of possible scenarios when this may be of use, such as to display the same measurement in different units, or to measure power at different points on the same test system.

Setting Up the Second Channel

1. Press the **Channel** hard key to display the Channel group of commands.
2. Press the [Set Up] soft key to display the [Channel Set Up] dialog for the channel that is currently active. The active channel is identified at the "Channel" item at the top of the dialog.
3. Press **Ch1/Ch2** to close the current dialog and display an identical dialog for the second channel. This button can be used at any time to jump between channels.
4. Make the required mode, measurement display, and input configuration settings for the second channel as explained earlier in this chapter.

5. Press the [Exit] key to close the [Channel Set Up] dialog and revert to the previous page of commands.

5-10 Displaying Both Channels Simultaneously

1. Press the **Channel** hard key to display the Channel group of commands.
2. Press the [Set Up] soft key to display the [Channel Set Up] dialog for the channel that is currently active. The active channel is identified at the "Channel" item at the top of the dialog.
3. Press the [Dual Channel] soft key to display both channels on screen simultaneously. The green LED on the [Dual Channel] button shows that this dual channel mode is enabled.

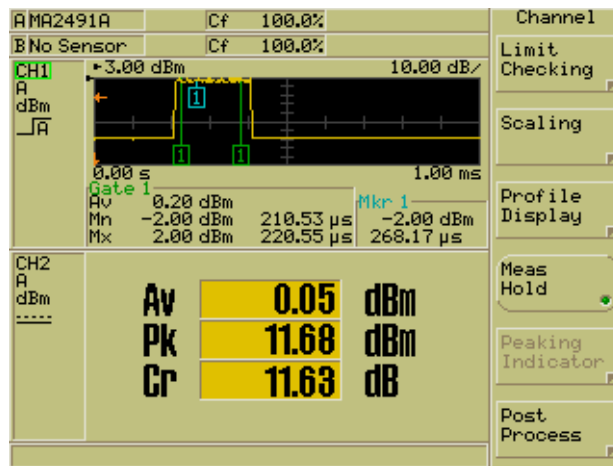

Figure 5-9. Dual Channel Display

4. Press the [Exit] key to close the [Channel Set Up] dialog and revert to the previous page of commands.
5. As shown in the figure below, both channels are now displayed simultaneously, channel 1 at the top and channel 2 at the bottom of the screen. Pressing the **Ch1/Ch2** hard key at any time jumps from one channel to the other, and the currently active channel is identified by the green border around the channel number.

5-11 Understanding Triggering

The following pages explain each of the settings in the [Trigger Set Up] dialog. The figure below provides an overview of the meaning of each setting. The black area in the figure represents the screen on the ML248xB / ML249xA.

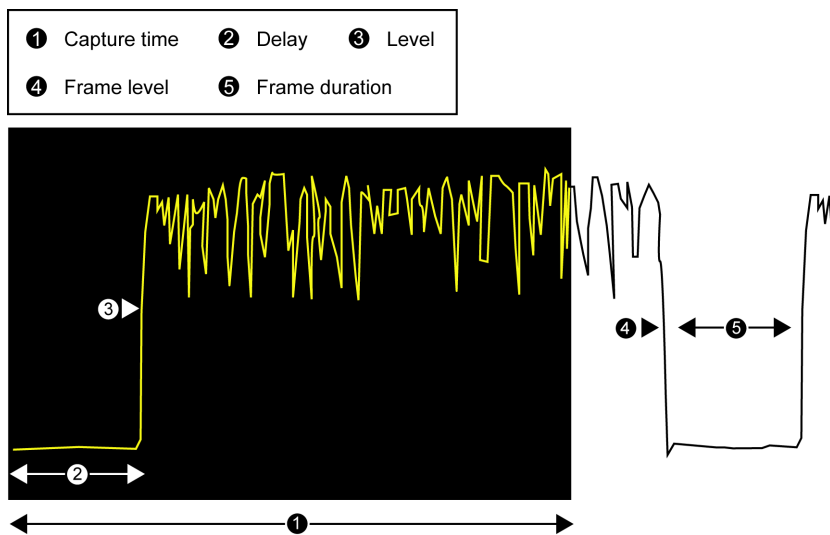

Figure 5-10. Triggering

5-12 Selecting the Triggering Mechanism

1. Press the **Channel** hard key to display the [Channel] group of commands.
2. Press the [Trigger] soft key to display the [Trigger] menu and then press the [Trigger Source] soft key to display the screen shown below.

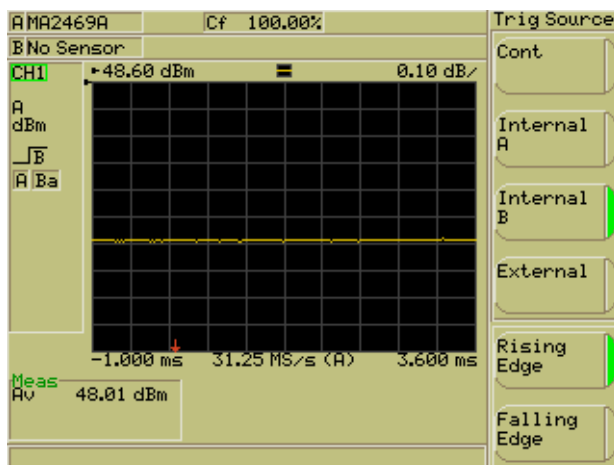

Figure 5-11. Trigger Source

3. Use the soft keys to select the triggering source. There are four possible settings available as detailed below.

Table 5-5. Trigger Source

Setting	Trigger action
Cont	The instrument restarts the acquisition process immediately after displaying the results. This setting is most suitable when there is no particular amplitude pattern in the measurement, such as is the case with CDMA.
Internal A	The trigger signal is obtained by monitoring the RF signal level measured by the sensor. Triggering occurs when the level crosses a specific point.
Internal B	The trigger signal is obtained from sensor B (ML2488B and ML2496A only).
External	Data acquisition is triggered by a TTL transition on the external input. The program can be set up to respond to either a rising or a falling edge.

5-13 Selecting the Type of Triggering

1. Press the **Channel** hard key to display the [Channel] group of commands.
2. Press the [Trigger] soft key to display the [Trigger] menu and then press the [Trigger Source] soft key to display the screen shown below.

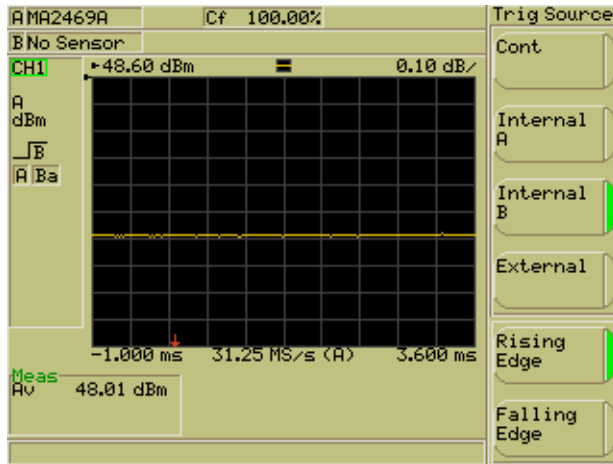

Figure 5-12. Trigger Type

Note The triggering type cannot be specified if the trigger source is set to "Continuous".

3. Use the soft keys to set triggering to occur on either the rising or falling edge of the signal.

5-14 Entering the Triggering Capture Time

The capture time represents the amount of data displayed on the screen at any one time. If a positive value is entered at the "Delay" item, the capture time will commence once the specified delay has been reached.

1. Press the **Channel** hard key to display the [Channel] group of commands.
2. Press the [Trigger] soft key to display the [Trigger] menu and then press the [Set Cap Time] soft key to display the screen shown below.

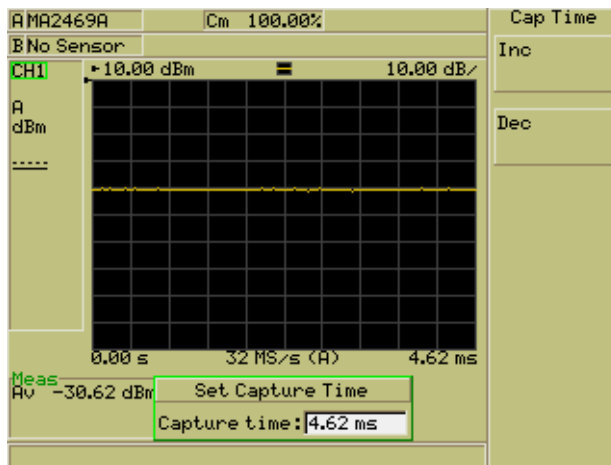

Figure 5-13. Trigger Capture Time

3. Specify the capture time using either of the methods below.
 - Use the [Inc] and [Dec] soft keys to increment or decrement the displayed value by the amount specified from **System** > [Config] > [Set Inc/Dec Steps].
 - Press the [Sel] key on the numeric keypad and enter a value as described in the previous chapter. Press the required units from the soft key when the required time has been set.

The capture time setting determines the effective sampling rate. Details of this are given in the table below.

Table 5-6. Capture Time and Sampling Rate

Capture time	ML248xB Sampling rate	ML249xA Sampling rate
50 ns to 3.19 μ s (#1)	N/A	RRS (#1)
3.2 μ s to 4.09 ms	64 MS/s	62.5 MS/s
4.1 ms to 8.19 ms	32 MS/s	31.25 MS/s
8.2 ms to 16.38 ms	16 MS/s	16 MS/s

(#1) Available for ML249xA only.

Random Repetitive Sampling (RRS) (ML249xA only)

As shown in the table on the previous page, if the capture time is set to a value less than 3.2 s, a random repetitive sampling (RRS) method is used to acquire the data. RRS is selected automatically as necessary by the power meter and no user setting is required. When active, an RRS flag displays in the top right corner of the channel display area.

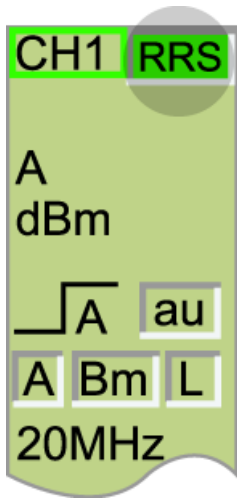

When RRS is active, an effective sampling rate of 1 Gsample per second is achieved by progressively filling up data slots until the entire trace has been acquired. The particular slot to which the data for any of the sweeps is written is determined by the time between the trigger and the first measurement point, and then the time from this point to the current measurement point. When an RRS measurement is being made but is not yet complete, the measurement and marker values display as a series of dashed lines. When all of the 16 data slots have been filled and the trace is complete, the readout values are then displayed, and the RRS indicator in the channel area of the screen changes from red to green.

It should be noted that as RRS relies upon multiple successive measurements of a repetitive signal, it is not available for continuously triggered measurements.

The message, "Out of range for continuous trigger" displays if an attempt is made to set the trigger capture time to less than 3.2 μ s when the trigger source is set to continuous.

5-15 Entering the Triggering Delay

A trigger delay allows the user to impose a time lag (positive or negative) between the trigger event and the data displayed on screen. Specifying a positive delay has the affect of zooming in on a section of the pulse occurring some time after the trigger event. Specifying a negative delay allows the user to display data occurring immediately before the trigger event.

1. Press the **Channel** hard key to display the [Channel] group of commands.
2. Press the [Trigger] soft key to display the [Trigger] menu and then press the [Set Trig Delay] soft key to display the screen shown below.

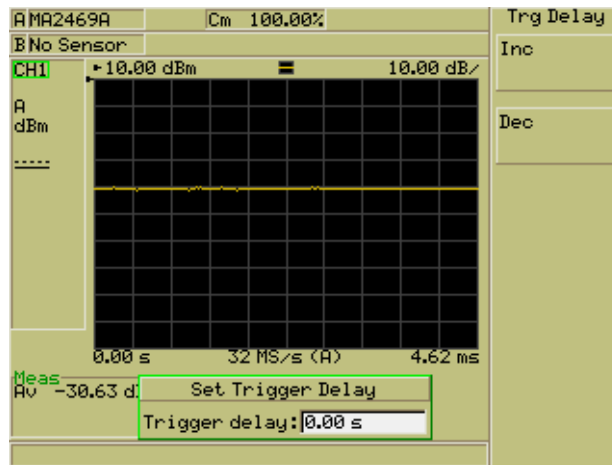

Figure 5-14. Trigger Delay

3. Specify the trigger delay using either of the methods below. A positive value represents a delay after the trigger point, and a negative value represents the time before the trigger allowing the user to display the pre-trigger information.
 - Use the [Inc] and [Dec] soft keys to increment or decrement the displayed value by the amount specified from **System** > [Config] > [Set Inc/Dec Steps].
 - Press the [Sel] key on the numeric keypad and enter a value as described in the previous chapter. Press the required units from the soft key when the required time has been set.

5-16 Enabling Auto Triggering

Both the ML248xB and the ML249xA units can be configured to trigger automatically as detailed below. The trigger level is specified automatically and no additional setting is required on the part of the operator.

1. Press the **Channel** hard key to display the [Channel] group of commands.
2. Press the [Trigger] soft key to display the [Trigger] menu and then press the [Trigger Level] > [Auto Trigger] soft keys.

- When auto triggering is enabled, the LED on the soft key is lit green and the trigger status icon shown below displays in the channel information section of the screen.

Note Auto triggering cannot be enabled if the trigger source is set to "Continuous" or "External".

5-17 Entering the Triggering Level

- Press the **Channel** hard key to display the [Channel] group of commands.
- Press the [Trigger] soft key to display the [Trigger] menu and then press the Trigger Level > Set Trig Level. soft keys to display the [Set Trigger Level] dialog shown below.

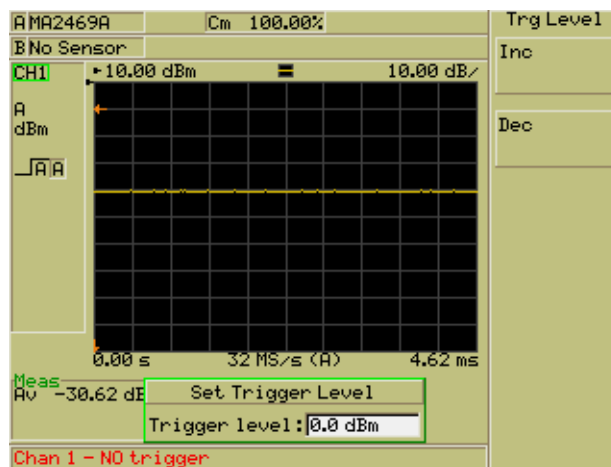

Figure 5-15. Trigger Level

Note The trigger level cannot be set if the "Source" item is set to "Continuous" or "External".

- Specify the trigger level using either of the methods below.
 - Use the [Inc] and [Dec] soft keys to increment or decrement the displayed value by the amount specified from **System** > [Config] > [Set Inc/Dec Steps].
 - Press the [Sel] key on the numeric keypad and enter a value as described in the previous chapter. Press the required units from the soft key when the required time has been set.

5-18 Selecting the Trigger Arming Method

1. Press the **Channel** hard key to display the [Channel] group of commands.
2. Press the [Trigger] soft key to display the [Trigger] menu and then press [More] followed by [Arming] to display the screen shown below.

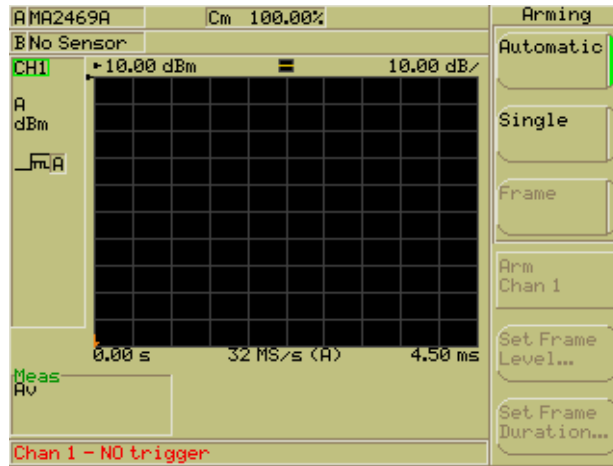

Figure 5-16. Trigger Arming

Note Arming settings cannot be made if the Trigger source item is set to "Continuous".

3. Use the soft keys to set the arming item to single, automatic, or frame. Refer to the table below.

Table 5-7. Trigger Arming

Setting item	Meaning
Automatic	The trigger is re-armed automatically after the trigger event has occurred.
Single (Not available for ML249xA when RRS is active)	The trigger is armed in response to a key press or remote control command. This allows a measurement to be captured and examined at leisure while internal or external trigger events continue to occur. If arming is set to "Single", the [Arm Chan X] command is enabled in the [Trigger] menu.
Frame	The trigger is armed on the condition that the signal level stays below the threshold specified using the [Set Frame Level] command for the period of time specified using [Set Frame Duration]. It should be noted that although frame arming is available on the ML249xA when RRS is active, manual sampling is unavailable at this setting.

5-19 Entering a Frame Arming Level and Duration

As explained on the previous page, a frame arming level and duration can be specified to find the off period of a pulsed waveform. The trigger is re-armed only on the condition that the signal stays below the specified level for the specified duration. Once the trigger has been re-armed the power meter will then always trigger on the first rising edge of the sequence of pulses after the off-period.

1. Press the **Channel** hard key to display the [Channel] group of commands.
2. Press the [Trigger] soft key to display the [Trigger] menu and then press [More] followed by [Arming].
3. Press the [Frame] soft key to enable use of the [Set Frame Level] and [Set Frame Duration] soft keys
4. Press [Set Frame Level] and set the frame level using either of the methods below.
 - Use the [Inc] and [Dec] soft keys to increment or decrement the displayed value by the amount specified from **System** > [Config] > [Set Inc/Dec Steps].
 - Press the [Sel] key on the numeric keypad and enter a value as described in the previous chapter.
5. Press [Set Frame Duration] and set the frame duration in the same manner.

5-20 Setting the Sampling Rate

This function allows the user to set the sampling rate for the active channel.

Note The sampling rate is only applicable to pulsed/modulated measurements.

1. Press the **Channel** hard key to display the [Channel] group of commands.
2. Press the [Trigger] soft key to display the [Trigger] menu and then press [More] followed by [Set Sample Rate] to display the [Set Sample Rate] dialog shown below.

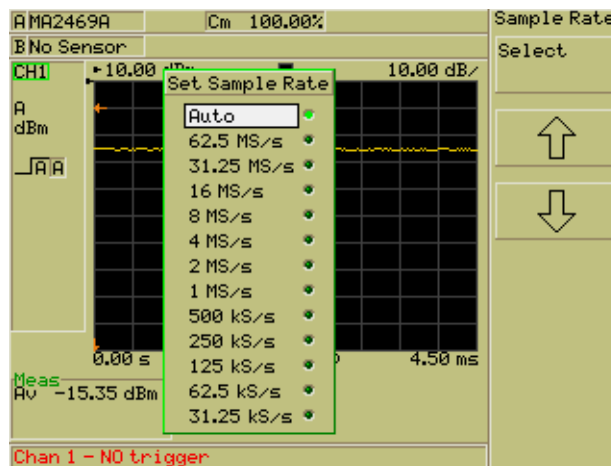

Figure 5-17. Sample Rate

- Use the up and down soft keys or the keys on the numeric keypad to select the required rate. The rate is enabled by pressing the [Select] soft key or the [Sel] key on the numeric keypad. The currently active rate is indicated by the green LED.

The current sampling rate displays beneath the profile graticule of a pulsed/modulated measurement. If "Auto" is selected as the sampling rate, (A) is displayed after the rate that the instrument has selected.

Note

The power meter can only hold a finite number of samples at any one time and the following 'rule' is followed:

Number of measurement points <= number of samples <= Max number of samples

When "Auto" is selected, the ML248xB / ML249xA calculates the fastest sample rate that will satisfy the above rule when used with the current capture time. If a user selected sampling rate is being used, the current capture time may result in the ML248xB / ML249xA trying to capture too many or too few samples. In this case the capture time will be adjusted so that the rule is satisfied. Changing the number of measurement points from 200 to 400 may also result in the capture time being changed.

The sample rates shown in the figure above are those for the ML248xB.

5-21 Selecting the Trigger Indicator

When operating in pulsed modulated mode with an internal or external trigger source, the user can display the trigger point as either a small arrow at the bottom of the trace, or as an additional stepped waveform

- Press the **Channel** hard key to display the [Channel] group of commands.
- Press the [Trigger] soft key to display the [Trigger] menu and then press [More] followed by Trigger Indication to display the [Trigger Ind] group of commands shown below.

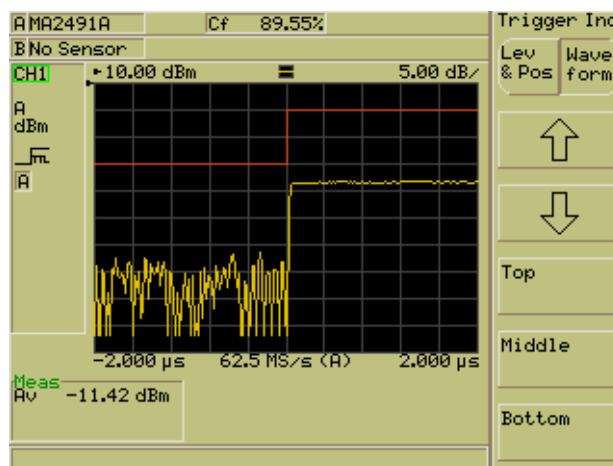

Figure 5-18. Trigger Indicator

3. Press the [Lev & Pos / Wave form] soft key to switch between the arrow and waveform trigger point displays. When waveform mode is selected, the step occurs at the trigger point and the direction matches the currently selected trigger edge. The waveform does not indicate the trigger level in any way and can be positioned at any point on the vertical axis using the up and down soft keys or jumped directly to the top, middle, or bottom of the graticule.

5-22 Linking the Channel Trigger Settings

The trigger settings for channel 1 and channel 2 can be linked in the manner described below. The channels can only be linked when the "Mode" setting in the [Channel Set Up] dialog is the same for both channels.

1. Press the **Channel** hard key to display the [Channel] group of commands.
2. Press the [Trigger] soft key to display the [Trigger] menu and then press [More] followed by [Link] soft key. When the key is pressed, the trigger settings for the active channel are copied to the inactive channel, and further changes are automatically copied over thereafter.

5-23 Gates and Fences

Up to four different gating patterns may be applied simultaneously to any measurement. Before going on to describe how the gates and fences are set up, it is first necessary to make sure that the terms themselves are understood.

Table 5-8. Gates and Fences

Term	Definition
Gate:	A gate is a specification for extracting an averaged power reading measurement between two defined points on a pulsed waveform. These points are defined with respect to the point in time at which the measurement trigger occurred.
Fence:	A fence is set up within the boundaries of a gate. All data sampled between the fence start and stop positions is excluded from the average power calculations for the associated gate. This is useful for purposes such as excluding a training sequence from an EDGE measurement.

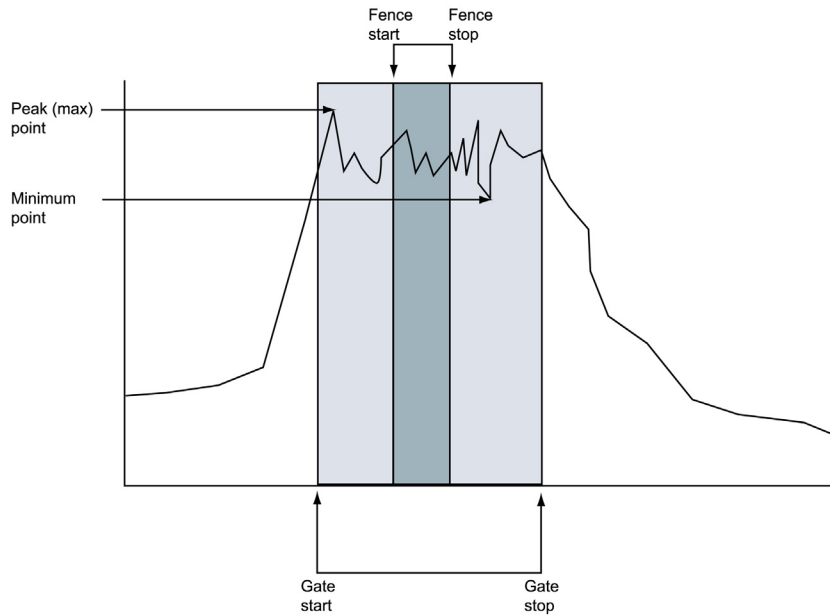

Figure 5-19. Gates and Fences

Certain restrictions and conditions apply when setting up gating and fence settings, these are listed below.

- A maximum of four gating patterns can be applied to any single measurement, or eight in a repeated gating pattern.
- The fence start and stop positions cannot be set outside of the area defined by the gate start and stop positions.
- The Gate Start and Stop points are included in the measurement.
- The Fence Start and Stop points are excluded from the measurement and have priority over the Gate Start and Stop points if they coincide.
- Gating patterns are independent and may overlap without interfering with each other.

5-24 Setting Up and Enabling Gates and Fences

1. Press the **Channel** hard key to display the [Channel] group of commands.
2. Press the [Gating] soft key followed by the [Set Up] soft key to display the [Gating Set Up] dialog. The dialog opens with the "Gate 1" setting already selected for user entry.

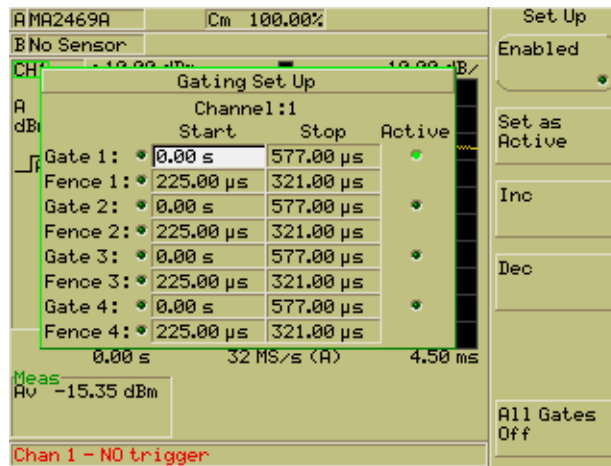

Figure 5-20. Gating Set Up

3. Enter the required time using either of the methods detailed below.
 - Use the [Inc] and [Dec] soft keys to increment or decrement the displayed value by the amount specified from **System** > [Config] > [Set Inc/Dec Steps].
 - Press the [Sel] button on the numeric keypad and enter a value. Select the required units from the soft key menu to set this value.
4. Press the right arrow on the numeric keypad to select the gate 1 stop item. Select the required units from the soft key menu to set this value.
5. Press the [Enabled] soft key to enable use of this gate setting. A green LED to the right of the "Gate 1" item is lit to show that this setting is currently enabled.
6. Repeat steps 3 to 5 above to make the required settings for fence 1.
7. Repeat steps 3 to 6 above to make and enable the second, third, and fourth fence/gate settings.
8. Set the active gate by selecting the required gate and pressing the [Set as Active] soft key. The green LED at the right of the dialog indicates the gate currently selected.

The active gate can also be set from the [Set Active Gate] soft key, refer to the section in this chapter titled "Setting the Active Gate".

9. Press the [Exit] key when complete to close the [Gating Set Up] dialog and revert to the previous page of commands.

The difference between an active gate and an enabled gate should be made clear.

Note **Enabled** An enabled gate is a gate that has been enabled for viewing but one for which measurement data is not made available unless operating the ML248xB / ML249xA remotely over a GPIB connection. All four of the gates can be enabled simultaneously.

Active: The active gate is the gate that is currently selected and being used as the boundary for the acquisition of data.

5-25 Viewing Gating Patterns

1. Press the **Channel** hard key to display the Channel group of commands.
2. Press the [Gating] soft key.
3. Press the [Display Gates] soft key to display the gates on the profile as shown in the figure below. The gate start and stop points appear on the profile as solid vertical green lines, and the fence points can be seen as dotted green lines.

The number of the gate displays at the base of the start and stop lines. If more than one gate has been enabled in the [Gating Set Up] dialog the concept of active and inactive gates is introduced.

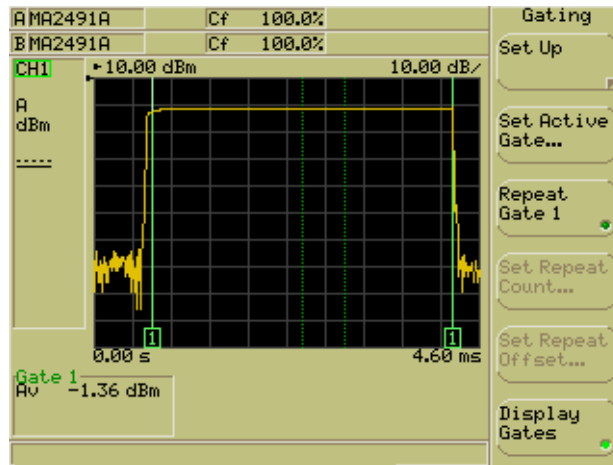

Figure 5-21. Gates

Note Gating patterns can only be viewed when the channel in question is viewed in profile mode. Refer to *Selecting the Measurement Display* earlier in this chapter for details of how to change the display mode.

5-26 Setting the Active Gate

Up to four gates can be enabled and viewed simultaneously on the profile display. In this situation, the gate that is currently active is shown on the display by a green box around the number at the base on the start and stop positions. This is shown in the figure below.

Follow the procedure below to specify the active gate.

1. Press the **Channel** hard key to display the Channel group of commands.
2. Press the [Gating] soft key.
3. Press [Set Active Gate] and enter the required gating number in the [Set Active Gate] dialog. The number is entered in the usual manner by pressing [Sel] on the numeric keypad to clear the current entry. Press the [Enter] soft key when complete, followed by the [Exit] key to close the dialog.

The display will now have been updated to display the specified number as the active gate.

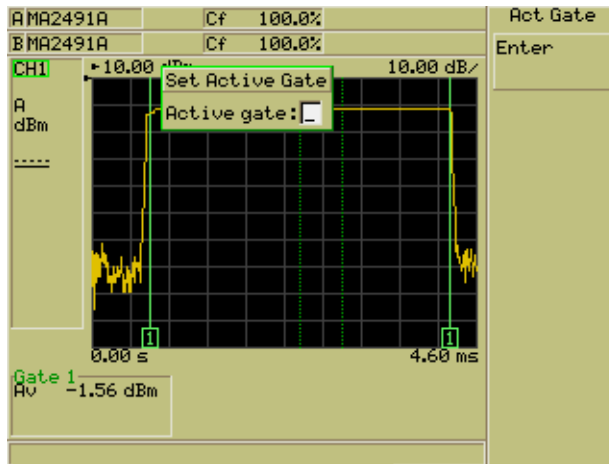

Figure 5-22. Set Active Gate

Note The active gate can also be set in the [Gating Set Up] dialog as described in the earlier section. Both access points are updated automatically regardless of where the settings are made.

5-27 Setting Up Repeat Gates

To facilitate the measurement of sequences on a regular basis, the user can select to repeat gate 1.

Follow the procedure below to make the gate repetition settings.

1. Press the **Channel** hard key to display the Channel group of commands.
2. Press the [Gating] soft key.

3. Press [Repeat Gate 1] to display the repeated gate on screen.

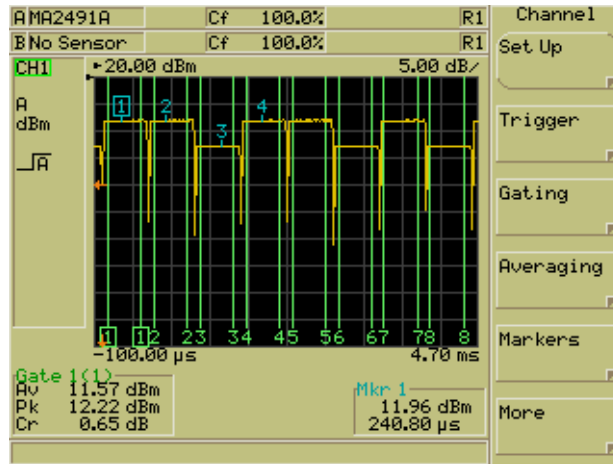

Figure 5-23. Repeat Gates

4. Press [Set Repeat Count] and specify the number of repetitions required by entering a number from the keyboard in the usual manner.
5. Press [Set Repeat Offset] and specify the offset between consecutive gates.

5-28 Averaging

The averaging settings allow the user to specify a given number of measurements over which the average result is then calculated. The commands found within the [Averaging] menu differ depending on whether the channel mode is set to Pulsed/Modulated or CW. Explanations in this section apply to both modes unless otherwise stated.

Setting Up Averaging

1. Press the **Channel** hard key to display the [Channel] group of commands.
2. Press the [Averaging] soft key to display the [Averaging] menu.

3. Press the [Set Avg Number] soft key to display the [Set Averaging Number] dialog.

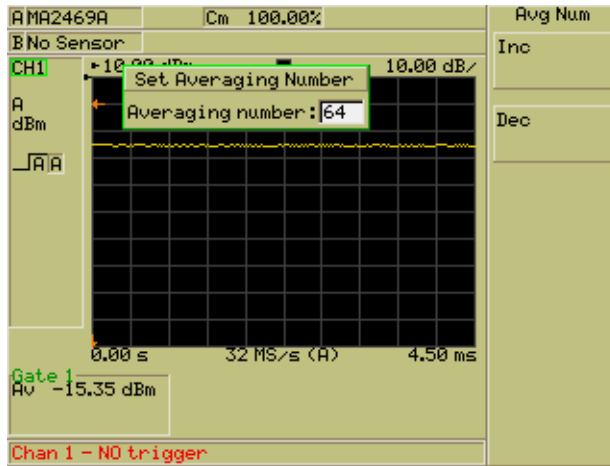

Figure 5-24. Averaging Set Up

4. Enter the required averaging number using either of the methods detailed below.
 - Use the [Inc] and [Dec] soft keys to increment or decrement the displayed value by a factor of two.
 - Press the [Sel] key on the keypad and enter the number of measurements over which the average will be calculated.

Note The maximum averaging value that can be specified is 512, and settings in excess of this are automatically reset to this maximum.

5-29 Enabling Averaging in Pulsed/Modulated Mode

1. Press the **Channel** hard key to display the [Channel] group of commands.
2. Press the [Averaging] soft key to display the [Averaging] menu.
3. Press the [Averaging] soft key to toggle averaging between on and off. When averaging is enabled, the LED on the soft key is lit green.

It is important to note that in pulsed / modulated mode, the higher the number that averaging is set to, the smaller the contribution of the new reading into the averaged value. If for example, averaging is set to 64, each point on the trace is averaged as follows:

$$(Current\ value \times 63/64) + (Newly\ acquired\ value \times 1/64)$$

From the above it can be seen that at this setting, only 1/64th of the new reading is reflected in the trace as opposed to 1/8th if, for example, averaging was set to a value of 8.

Note If averaging is set, the letters "AV" display at the left side of the monitor. A flashing square icon to the right of this indicates that averaging is being performed, and the currently specified averaging value displays to the left of this icon. Refer to the explanation of the screen in chapter 4 of this manual.

5-30 Enabling Averaging in CW Mode

1. Press the **Channel** hard key to display the [Channel] group of commands.
2. Press the [Averaging] soft key to display the [Averaging] menu.
3. There are four averaging settings available as detailed below.

Table 5-9. Averaging Settings

Setting	Meaning
Off:	Averaging is not performed.
Auto:	Averaging is performed automatically depending on the power level.
Moving:	<p>Averaging is continuously performed over the number of measurements specified. When the specified number is reached the average is calculated and as the next measurement is finished the average is recalculated from the new start and stop positions. Refer to the figure below that shows moving averaging performed over 8 measurements.</p> <div style="text-align: center;"> </div>
Repeat:	<p>Averaging is performed over the number of measurements specified. The averaging value is not recalculated until the next entire batch of measurements is complete. Refer to the figure below that shows repeat averaging performed over 8 measurements.</p> <div style="text-align: center;"> </div>

4. Use the soft keys to select the averaging setting required.

5-31 Restarting Averaging in Pulsed/Modulated Mode

1. Press the **Channel** hard key to display the [Channel] group of commands.
2. Press the [Averaging] soft key to display the [Averaging] menu.
3. Press the [Restart Averaging] soft key.



5-32 Markers

The ML248xB / ML249xA can display up to four markers and one delta marker on a profile display at any time. Each of the markers is assigned a number, and the marker that is set up as the active marker is shown on screen by a number in a blue box. The delta marker is shown by a triangular symbol and is used as the reference for differential calculations with the active marker. The calculation between the delta and active markers can be set to show the difference in power level behind the two points, or to show the average power between the two markers.

Note

Markers are not available when the measurement display for the channel in question is set to Readout.

Table 5-10. Marker Types

Marker	Meaning
1	The non-active markers are shown by a blue number.
	The active marker is enclosed in a blue box. Any of the four regular markers can be set up as the active marker.
	The delta maker is shown by a blue triangle. The delta marker is used as the reference for calculations with the active marker.

5-33 Setting Markers

1. Press the **Channel** hard key followed by the [Markers] soft key to display the Markers group of commands.
2. Press the [Set Up Markers] soft key to display the [Marker Set Up] dialog. The dialog shows a numeric position for each of the markers.

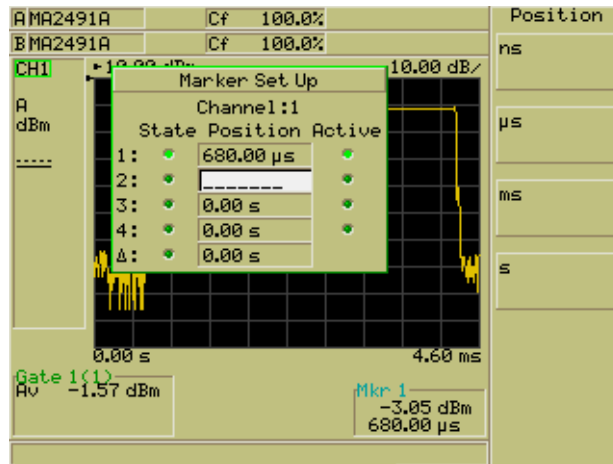

Figure 5-25. Marker Set Up

3. Use the arrows on the keypad to select the marker, and then enter the required position using either of the methods detailed below.
 - Use the [Inc] and [Dec] soft keys to increment or decrement the displayed value.
 - Press the [Sel] key on the keypad and enter the number in the usual manner.
4. Once the position has been set the user can chose to display the marker by pressing [Display Marker]. The LED to the left of the input value is lit green when the marker is set to be displayed.

- Use the down arrow on the numeric keypad to move to the remaining markers, and repeat steps 3 and 4 above.

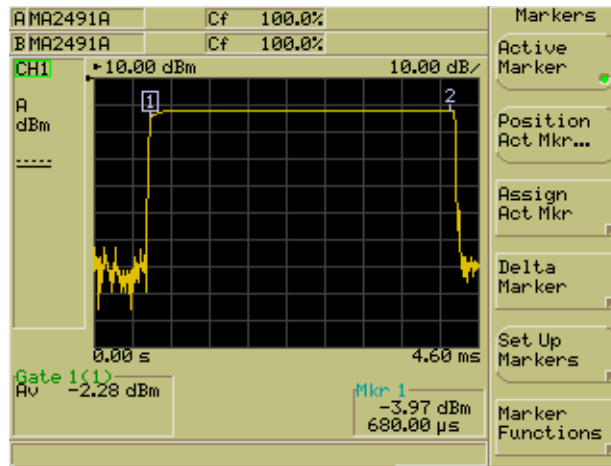

Figure 5-26. Marker Set Up

- Press [Exit] to close the [Marker Set Up] dialog when all settings are complete.

5-34 Turning all Markers Off

- Press the **Channel** hard key followed by the [Markers] soft key to display the [Markers] group of commands.
- Press the [Set Up Markers] soft key to display the [Marker Set Up] dialog.
- Press the [All Mkrs Off] soft key to clear all markers from the display.

5-35 Setting and Viewing the Active Marker

- Press the **Channel** hard key followed by the [Markers] soft key to display the Markers group of commands.
- Press the [Assign Act Mkr] soft key and select the marker to serve as the active marker.

Note

The active marker can also be set by pressing the [Set Up Markers] soft key to display the [Marker Set Up] dialog, selecting the required marker, and pressing the [Set as Active] soft key. The changes made to the active marker using either of these methods are reflected at both locations.

5-36 Positioning the Active Marker

There are two ways in which the position of the active marker can be changed.

Method 1

1. Press the **Channel** hard key followed by the [Markers] soft key to display the [Markers] group of commands.
2. Press the [Position Act Mkr] soft key in the [Markers] group of commands and set the required marker position using the [Inc] and [Dec] soft keys, or the numeric keypad in the normal manner. If the [Position Act Mkr] soft key is not available, press the [Active Marker] soft key to enable it.

Method 2

Use the right and left arrow keys on the numerical keypad to move the active marker on the active channel to the required position.

5-37 Positioning the Delta Marker

Two methods are available to position the delta marker.

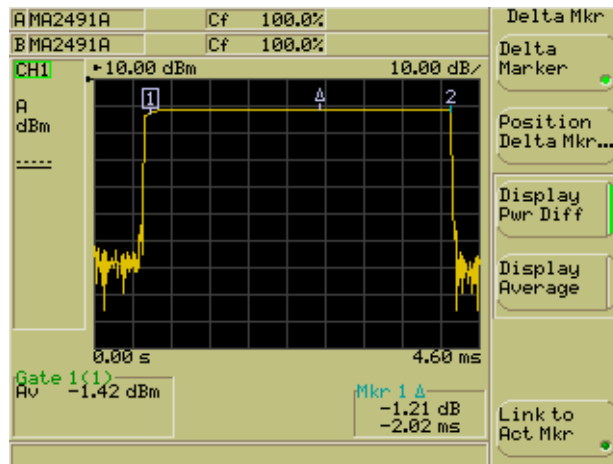

Figure 5-27. Delta Marker

Method 1

1. Press the **Channel** hard key followed by the [Markers] soft key to display the [Markers] group of commands.
2. Press the [Delta Marker] soft key to display the [Delta Mkr] group of commands.
3. Press the [Delta Marker] soft key to enable the display of the delta marker. When the delta marker is visible the green LED on the [Delta Marker] soft key is lit.
4. Press the [Position Delta Mkr] soft key to display the [Position Delta Marker] dialog.

5. Enter a value using the [Inc] and [Dec] soft keys, or from the keypad in the normal manner.

Method 2

1. Press the **Channel** hard key followed by the [Markers] soft key to display the [Markers] group of commands.
2. Press the [Delta Marker] soft key to display the [Delta Mkr] group of commands.
3. Press the [Delta Marker] soft key to enable the display of the delta marker. When the delta marker is visible the green LED on the [Delta Marker] soft key is lit.
4. Check that a green LED is visible on the [Keys Move Delta Mk] soft key and then use the right and left arrow on the keypad to position the delta marker as required.

Note The active marker is displayed automatically when the delta marker is enabled.
--

5-38 Setting the Delta Marker Calculation

The delta marker can be used to show either of the following calculations:

- The difference in power level between the delta marker and the active marker.
- The average power between the delta marker and the active marker.

In both cases, the calculated value is shown on the screen at the active marker measurement readout. Follow the procedure below to select the required calculation.

1. Press the **Channel** hard key followed by the [Markers] soft key to display the [Markers] group of commands.
2. Press the [Delta Marker] soft key and select either [Display Pwr Diff] or [Display Average].

5-39 Linking the Delta Marker to the Active Marker

Follow the procedure below to link the delta marker to the movement of the active marker such that the time difference between the two remains constant.

1. Press the **Channel** hard key followed by the [Markers] soft key to display the [Markers] group of commands.
2. Press the [Delta Marker] soft key followed by [Link to Act Mkr]. When the delta and active markers are linked in this manner, the LED on the soft key is lit green.

5-40 Moving the Active Marker to the Maximum Point

1. Press the **Channel** hard key followed by the [Markers] soft key to display the [Markers] group of commands.
2. Press the [Marker Functions] soft key to display the [Mkr Funcs] group of commands.

3. Press the [Active to Max] soft key.

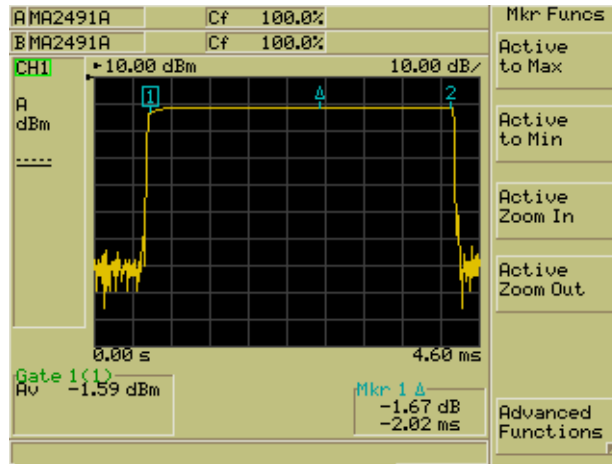

Figure 5-28. Marker Functions

5-41 Moving the Active Marker to the Minimum Point

1. Press the **Channel** hard key followed by the [Markers] soft key to display the [Markers] group of commands.
2. Press the [Marker Functions] soft key to display the [Mkr Funcs] group of commands.
3. Press the [Active to Min] soft key.

5-42 Zooming In or Out on the Active Marker

1. Press the **Channel** hard key followed by the [Markers] soft key to display the [Markers] group of commands.
2. Press the [Marker Functions] soft key to display the [Mkr Funcs] group of commands.
3. Press the [Active Zoom In] or [Active Zoom Out] soft keys to zoom in or out around the active maker.

Note

The number of measurement points displayed is reduced each time the [Active Zoom In] soft key is pressed.

5-43 Measuring the Pulse Rise Time

The rise time of the pulse that the active marker is currently position on can be calculated automatically as described below. The delta marker is set by default to the 90% linear power point on the rising edge, and the active marker is set to the 10% linear power point. These positions can be adjusted as required using the [Search Set Up] soft key. Refer to the Setting the Search Target Levels later in this chapter.

1. Ensure that the active marker is positioned on top of the pulse for which measurement is required. If it is not, use the right and left arrow keys on the numeric keypad to position the active marker as required.
2. Press the **Channel** hard key followed by the [Markers] soft key to display the [Markers] group of commands.
3. Press the [Marker Functions] soft key to display the [Mkr Funcs] group of commands.
4. Press the [Advanced Functions] soft key to display the [Adv Funcs] group of commands.
5. Press the [Pulse Rise Time] soft key.

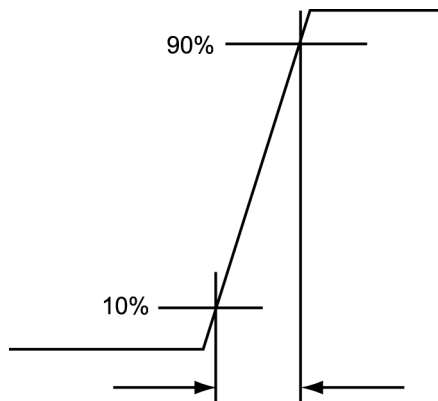

Figure 5-29. Pulse Rise Time

Note

Measurement is limited by a sampling resolution of 16 ns / point and a display resolution of 200 / 400 points. For the highest resolution, the power meter must be set to a capture time of 3.2 μ s and 200 points, i.e. 200 x 16 ns = 3.2 μ s, or 400 x 16 ns = 6.4 μ s.

5-44 Measuring the Pulse Fall Time

The fall time of the pulse that the active marker is currently positioned on can be calculated automatically as described below. The delta marker is set by default to the 10% linear power point on the falling edge, and the active marker is set to the 90% linear power point. These positions can be adjusted as required using the [Search Set Up] soft key. Refer to the Setting the Search Target Levels later in this chapter.

1. Ensure that the active marker is positioned on top of the pulse for which measurement is required. If it is not, use the right and left arrow keys on the numeric keypad to position the active marker as required.
2. Press the **Channel** hard key followed by the [Markers] soft key to display the [Markers] group of commands.
3. Press the [Marker Functions] soft key to display the [Mkr Funcs] group of commands.
4. Press the [Advanced Functions] soft key to display the [Adv Funcs] group of commands.

5. Press the [Pulse Fall Time] soft key.

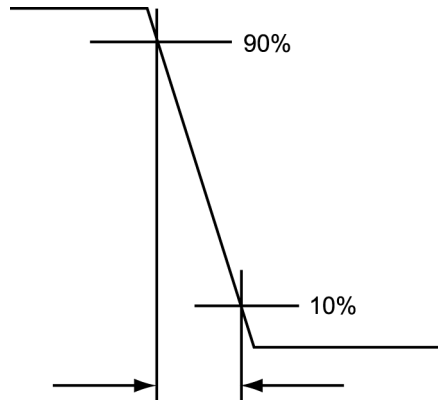

Figure 5-30. Pulse Fall Time

Note

Measurement is limited by a sampling resolution of 16 ns / point and a display resolution of 200 / 400 points. For the highest resolution, the power meter must be set to a capture time of 3.2 μ s and 200 points, i.e. $200 \times 16 \text{ ns} = 3.2 \mu\text{s}$, or 400 \times 16 ns = 6.4 μ s.

5-45 Measuring the Pulse Width

The width of the pulse that the active marker is currently positioned on can be calculated automatically as described below. The delta marker is set to the 50% linear power point on the falling edge, and the active marker is set to the 50% linear power point on the rising edge.

1. Ensure that the active marker is positioned on top of the pulse for which measurement is required. If it is not, use the right and left arrow keys on the numeric keypad to position the active marker as required.
2. Press the **Channel** hard key followed by the [Markers] soft key to display the [Markers] group of commands.
3. Press the [Marker Functions] soft key to display the [Mkr Funcs] group of commands.
4. Press the [Advanced Functions] soft key to display the [Adv Funcs] group of commands.

5. Press the [Pulse Width] soft key.

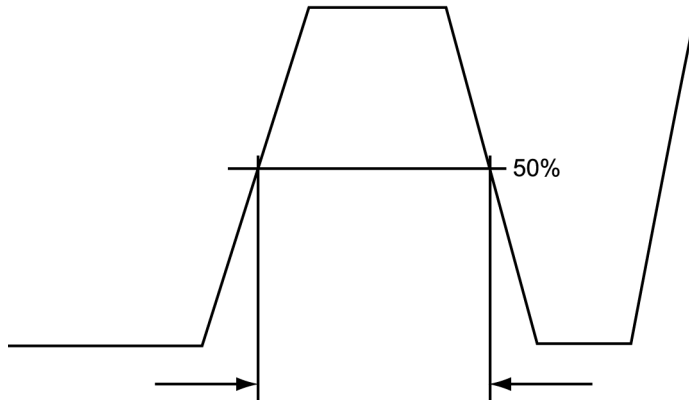

Figure 5-31. Pulse Width

5-46 Measuring the Off Time

The off time of the pulse that the active marker is currently positioned on can be calculated automatically as described below. The active marker is set to the 50% point on the falling edge, and the delta marker is set to the 50% point on the rising edge of the next pulse.

1. Ensure that the active marker is positioned on top of the pulse immediately prior to the off time to be measured. If it is not, use the right and left arrow keys on the numeric keypad to position the active marker as required.
2. Press the **Channel** hard key followed by the [Markers] soft key to display the [Markers] group of commands.
3. Press the [Marker Functions] soft key to display the [Mkr Funcs] group of commands.
4. Press the [Advanced Functions] soft key to display the [Adv Funcs] group of commands.

5. Press the [Off Time] soft key.

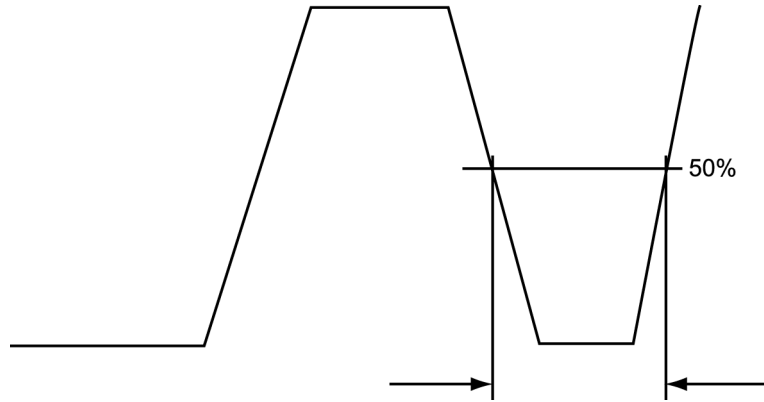

Figure 5-32. Pulse Off Time

5-47 Measuring the Pulse Repetition Interval

The repetition interval of the pulse that the active marker is currently positioned on can be calculated automatically as described below. The active marker is set to the 50% point on the rising edge, and the delta marker is set to the 50% point on the rising edge of the next pulse.

1. Ensure that the active marker is positioned on top of the pulse to be included in the measurement. If it is not, use the right and left arrow keys on the numeric keypad to position the active marker as required.
2. Press the **Channel** hard key followed by the [Markers] soft key to display the [Markers] group of commands.
3. Press the [Marker Functions] soft key to display the [Mkr Funcs] group of commands.
4. Press the [Advanced Functions] soft key to display the [Adv Funcs] group of commands.

5. Press the [PRI] soft key.

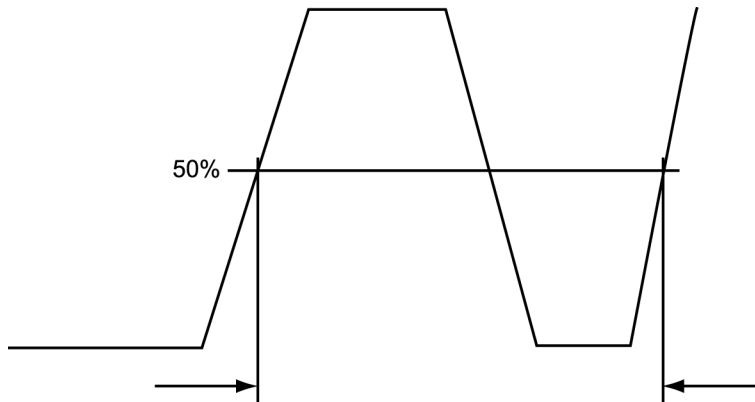

Figure 5-33. Pulse Repetition Interval

5-48 Setting the Search Target Levels

This function is used to set the upper and lower target levels for the pulse rise and fall time searches. It is also used to select the search start source.

1. Press the **Channel** hard key followed by the [Markers] soft key to display the [Markers] group of commands.
2. Press the [Marker Functions] soft key to display the [Mkr Funcs] group of commands.
3. Press the [Advanced Functions] soft key to display the [Adv Funcs] group of commands.
4. Press the [Search Set Up] soft key to display the [Marker Search Set Up] dialog shown below.

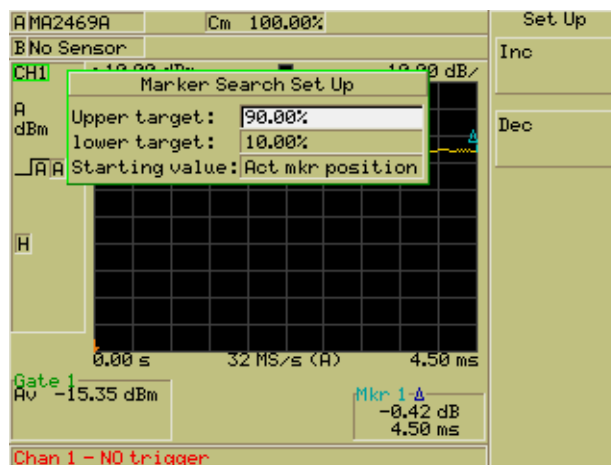

Figure 5-34. Marker Search Set Up

5. Use the up or down arrow keys to select the upper and lower target fields and enter a value using the [Inc] and [Dec] soft keys, or from the keypad in the normal manner.
6. Move down the "Starting value" field and set the source to be either the active marker position or active gate average.

5-49 Setting the Duty Cycle in CW Mode

This menu is used to set up and apply duty cycle correction to the currently active channel in CW mode.

1. Ensure that the currently active channel is set to CW mode.
2. Press the **Channel** hard key followed by the [Duty Cycle] soft key.
3. Press the [Set Duty Cycle] soft key to display the [Set Duty Cycle] dialog. Press [Sel] and enter the required duty cycle correction value from the keypad in the normal manner.
4. Press [Exit] and then press the [Duty Cycle] soft key to enable the setting. When the duty cycle setting is enabled, the LED on the soft key is lit green.

5-50 Limits

Upper and lower limits can be used during measurement to check that the results of measurement fall within an acceptable range. Limits can be set up by using one of those already defined within the instruments firmware, or by creating either a simple or complex limit specification.

5-51 Creating and Viewing Simple Limits

A simple limit is one with only one segment and is thus shown on the profile as a straight line. The user can choose to set only an upper limit, only a lower limit, or both an upper and a lower limit. Simple limits can be used in both CW and Pulsed / Modulated modes.

1. Press the **Channel** hard key followed by the [More] soft key.
2. Press the [Limit Checking] soft key soft key to display the [Lim Check] group of commands.

3. Press the [Set Up] soft key to display the [Limit Checking Set Up] dialog.

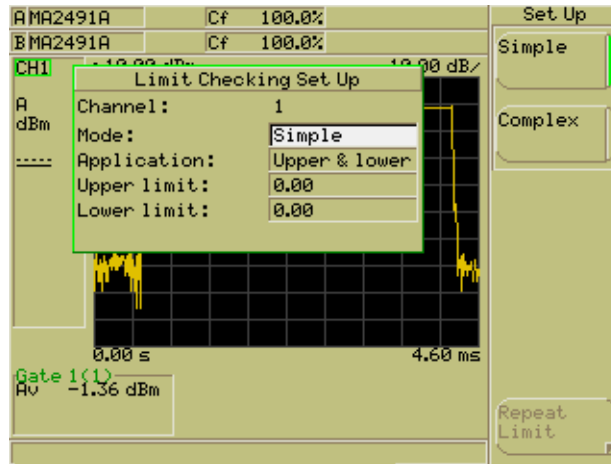

Figure 5-35. Limit Checking Set Up

4. Make sure that the "Channel" item in the dialog is displaying the channel for which the limit settings are required. If the channel is incorrect, press the **Ch1/Ch2** hard key to change the active channel.
5. The "Mode" item is selected automatically when the dialog is opened. Select the [Simple] soft key.
6. Press the down arrow on the numeric keypad to select the "Application" item in the dialog and then use the soft keys to select either upper and lower limits, upper only, or lower only.
7. Press the down arrow on the numeric keypad to select the upper and / or lower limit setting item(s) in the dialog and enter the required value(s) using the [Inc] and [Dec] soft keys, or from the keypad in the normal manner. Press [Exit] when all settings are complete.
8. Press the [Limit Checking] soft key in the [Lim Check] menu to enable and display the limits on the screen. When limit checking is enabled, the green LED on the soft key is lit and the word "Limit" displays at the left side of the screen.

5-52 Creating and Saving Complex Limits

A complex limit is one with multiple segments that allow the user to change the limit at, for example, different points in time along a GSM burst. Each segment within the complex limit is defined by specifying a point in time relative to the trigger point and an associated power level. Complex limits cannot be used in CW mode.

Note

Once created and saved in the manner described below, the user can recall any of the limit specifications and use the time and amplitude offset items to shift the limit lines to a different time or amplitudinal position on the trace. Refer to *Recalling User or Predefined Complex Limits*.

1. Press the **Channel** hard key followed by the [More] soft key.
2. Press the [Limit Checking] soft key to display the [Lim Check] group of commands.
3. Press the [Edit Limit Spec] soft key to display the [Edit Limit Specification] dialog.
4. Press the [Edit Segments] soft key to display the [Edit Seg] group of commands and then press the Add Segment soft key. When the [Add Segment] soft key is pressed the first field in the limit specification table is highlighted for user entry.

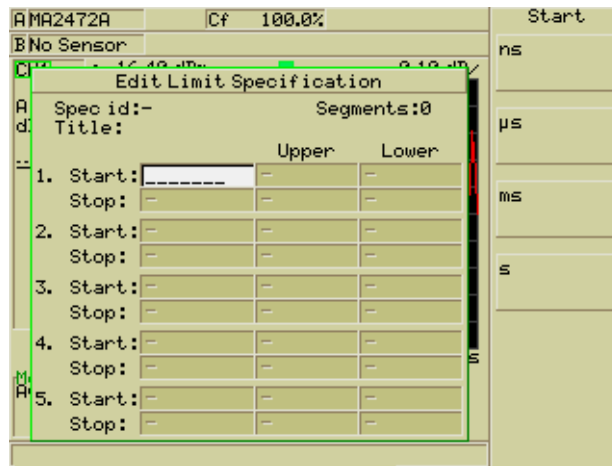

Figure 5-36. Limit Specifications

5. Enter a start time from the keypad in the usual manner and then press the right arrow on the keypad to enter an upper and / or lower limit value as required.

Note

The upper and lower values specified in the [Edit Limit Specification] dialog are unitless and reference the units specified in the [Channel Set Up] dialog. Refer to Setting the Units of Measurement earlier in this chapter.

6. Press the down arrow on the keypad and enter the settings for the Stop point on the first segment. Repeat this process until all the required segments have been specified.
7. Press the [Back] key and then press the [Edit Title] soft key. Enter a title from the keypad and press [Enter].
8. Press the [Save Spec] soft key followed by the [Save as] soft key. Use the hard or soft key arrows to select a vacant slot within the [User Limits] dialog, and then press [Select].
9. Press [Exit] to close the specifications table and then press the [Set Up] soft key to open the [Limit Checking Set Up] dialog.
10. Select the limit settings by setting the "Mode" item to 'Complex'. Use the down arrow to select the "Specification id" item, press the [User Limit Spec] soft key and select the specification saved in step 8 above.

11. Press [Exit] to close the dialog and then press the [Limit Checking] soft key to display the limits on the screen. When limit checking is enabled, the green LED on the soft key is lit and the word "Limit" displays at the left side of the screen.

5-53 Recalling User or Predefined Complex Limits

Once created and saved in the manner described above, the user can quickly and easily recall any of the limit specifications. In addition to the user defined specifications, a number of predefined limit specifications are also available.

1. Press the **Channel** hard key followed by the [More] soft key.
2. Press the [Limit Checking] soft key to display the [Lim Check] group of commands.
3. Press the [Set Up] soft key to display the [Limit Checking Set Up] dialog.
4. The "Mode" item is selected automatically when the dialog is opened. Select the [Complex] soft key.
5. Press the down arrow on the numeric keypad to select the "Application" item in the dialog and then use the soft keys to select to create either upper and lower limits, upper only, or lower only.
6. Press the down arrow on the numeric keypad to select the "Specification id" item in the dialog and then use the soft keys to select either [User Limit Spec] or [Predefined Limit Spec]. The difference between these two spec options is explained below.

Table 5-11. Limit Spec Types

Setting item	Meaning
User Limit Spec	Selecting [User Limit Spec] opens a [User Limits] dialog from which the user can select any of up to 30 settings created and saved in the manner described on the previous page. Once loaded, the limit settings can be edited and resaved as required.
Predefined Limit Spec	Selecting [Predefined Limit Spec] opens a [Predefined Limits] dialog from which the user can select any of a number of predefined limit settings. Once loaded, the limit settings can be edited and saved under a different name to a vacant slot in the [User Limits] dialog.

7. Use the soft key arrows, or the arrows on the keypad, to select the required User or Predefined limit from the dialog and press the [Select] soft key. The slot number of the selected item displays within the "Specification id" field followed by either "(User)" or "(Predefined)". The required limit specification can also be selected by highlighting the "Specification id" field, pressing [Sel] on the keypad and entering the slot number of the specification to be used. After entering the slot number, select either the User or [Predefined] soft key to complete entry at this field.
8. Press the down arrow on the numeric keypad to select the "Amplitude offset" and "Time offset" items in the dialog. Enter a value as required using the [Inc] and [Dec] soft keys, or at the numeric keypad in the normal manner. The offset items are used to shift the limit lines to a different time or amplitudinal position on the trace without forcing the user to recalculate and respecify each of the segment points in turn.

9. Press the [Exit] key to close the dialog and then press the [Limit Checking] soft key in the [Lim Check] menu to enable and display the limits on the screen. When limit checking is enabled, the green LED on the soft key is lit and the word "Limit" displays at the left side of the screen.

5-54 Editing Complex Limits

User generated limit settings can be opened, edited as required, and then resaved or saved under a different name.

Predefined limits can be opened and edited and saved under a new name to a vacant slot in the [User Limits] dialog. Predefined limits cannot be overwritten.

1. Press the **Channel** hard key followed by the [More] soft key.
2. Press the [Limit Checking] soft key to display the [Lim Check] group of commands.
3. Press the [Edit Limit Spec] soft key to display the [Edit Limit Specification] dialog.
4. Press the [Select Spec] soft key and select either [User Limit Spec] or [Predefined Limit Spec].
5. Use the soft key arrows, or the arrows on the keypad to select the required User or Predefined limit from the dialog and press the [Select] soft key. The values for the limit specification now display within the table.

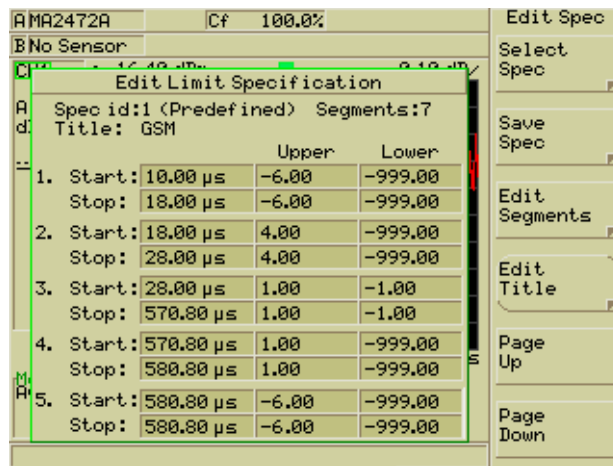

Figure 5-37. Edit Limit Specifications

Note

The value of -999.00 is used in the specification above to ensure that a lower limit failure is not needlessly generated at certain points on the trace.

6. Press the [Edit Segments] soft key and then edit the values from the keypad as required.
7. When editing is complete, press [Back] and then press the [Save Spec] soft key.
8. Use the Save or Save As options to save the changes made.

5-55 Repeating Limits

Complex limits can be repeated up to 8 times.

1. Press the **Channel** hard key followed by the [More] soft key.
2. Press the [Limit Checking] soft key to display the [Lim Check] group of commands.
3. Press the [Set Up] soft key to display the [Limit Checking Set Up] dialog.
4. Select the complex limit specification to be repeated by making the required settings in the [Limit Checking Set Up] dialog as detailed on the previous pages.
5. Press the [Repeat Limit] soft key to display the [Repeat Limit] dialog. Enter the number of repeats required (2 to 8) and a time and / or amplitude offset to be used between each repeat.
6. Press the [Repeat Limit] soft key to enable the repetition when the limits lines are displayed on screen. When limit repeating is enabled, the green LED on the soft key is lit
7. Press [Exit] to close each dialog in turn and press the [Limit Checking] soft key to display

5-56 Holding the Limit Fail Indicator

Fail Hold can be used to prevent the "Fail" flag in the channel information area reverting to "Pass" if subsequent measurements fall back within the limit specifications.

1. Press the **Channel** hard key followed by the [More] soft key.
2. Press the [Limit Checking] soft key to display the [Lim Check] group of commands.

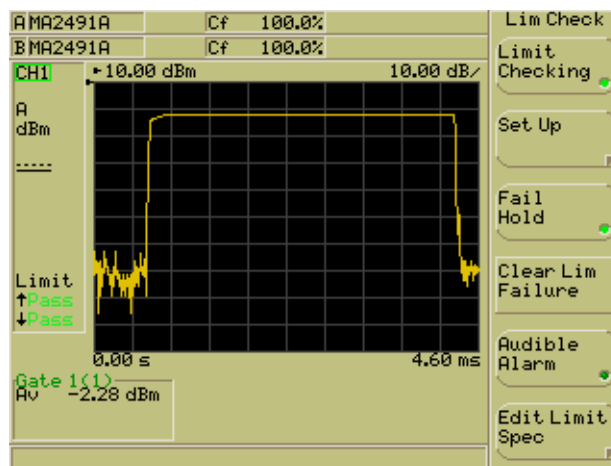

Figure 5-38. Limit Checking

3. Press the [Fail Hold] soft key. When this function is enabled, the green LED on the soft key is lit. If the results of measurement fall outside any of the specified limits the word "Fail" displays in the limit area at the left side of the screen.

4. In the event of a limit failure, the user can press the [Clear Lim Failure] soft key to set the pass/fail flag back to "Pass".

5-57 Sounding an Alarm on Limit Failure

If simple or complex limits have been enabled as described on the previous pages, the use can chose to sound an alarm if the results go outside any of the specified limits.

1. Press the **Channel** hard key followed by the [More] soft key.
2. Press the [Limit Checking] soft key to display the [Lim Check] group of commands.
3. Press the [Audible Alarm] soft key. When this function is enabled, the green LED on the soft key is lit. If the results of measurement fall outside any of the specified limit(s) an alarm is sounded to alert the user to the limit failure.

5-58 Adjusting and Resetting the Trace Measurement Scale

1. Press the **Channel** hard key followed by the [More] soft key.
2. Press the [Scaling] soft key soft key to display the [Scaling] group of commands.
3. The reference level and scale can be set by selecting either [Set Ref] or [Set Scale] and using the [Inc] and [Dec] soft keys, or by pressing [Sel] and then entering a number at the keypad.
4. The [Autoscale] command within the [Scaling] menu can be used at any time to automatically set the reference level and scale such that the whole of the trace can be displayed.

Note

The commands relating to scaling are only available when the measurement display setting for the active channel is set to profile.

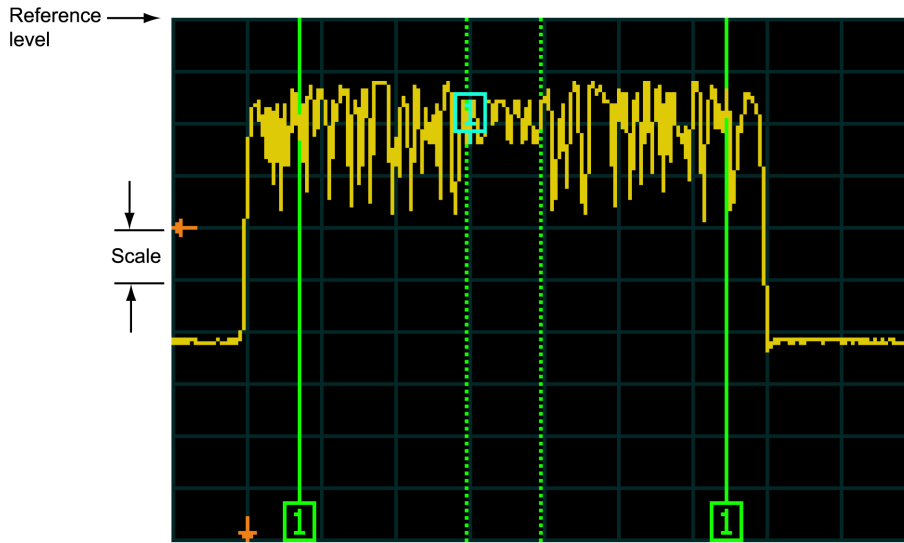

Figure 5-39. Trace Measurement Scale

5-59 Setting the Profile Display Style

The digital signal processor uses a number of algorithms to determine how the measurements made are processed and thereafter displayed on the screen as one of the points on the profile display. By default each point on the profile represents the average of multiple measurements although this can be changed by the user to show the minimum, the maximum, or both.

1. Press the **Channel** hard key followed by the [More] soft key.
2. Press the [Profile Display] soft key soft key to display the [Prof Disp] group of commands.

3. Press the soft keys to select either average, Avg, Min & Max, Min, or Max. The profile is updated automatically when the user switches between display options. The icon at the top of the screen is used to illustrate the mode that is currently active. The figure below illustrates the affect of changing the profile display mode on a simple pulse.

Avg

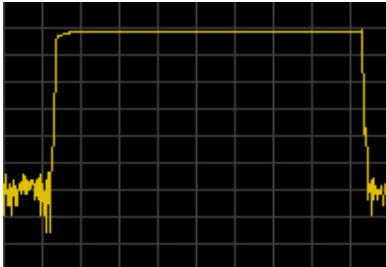

Min & Max

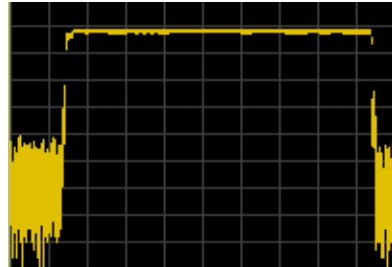

Min

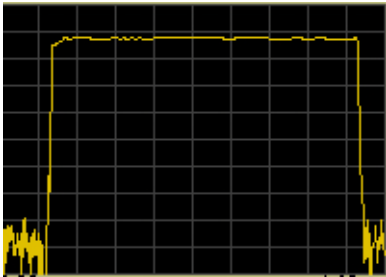

Max



Note

The average, min, and max display settings are represented on the profile as a single line. The min & max setting is displayed as a series of vertical lines showing the maximum and minimum values at each measurement point.

5-60 Setting the Profile Display Data Hold Method

1. Press the **Channel** hard key followed by the [More] soft key.
2. Press the [Profile Display] soft key to display the [Prof Disp] group of commands.
3. Press the [Data Hold] soft key soft key to display the [Data Hold] group of commands.

Note

The [Data Hold] soft key is not available if profile display setting detailed on the previous page is set to [Avg].

Holding Measurement Data in the Currently Active Channel **Channel Menu Reference**

4. Use the soft keys to select either single or infinite data holding. Refer to the table below.

Table 5-12. Data Hold Method

Item	Meaning
Single	The profile trace display uses the minimum and maximum measurement point values from each sweep.
Infinite	The minimum and maximum measurement point values are tracked over time. The values are stored from the time that the function is turned on until the time that it is turned off or the values are reset by pressing the [Reset] soft key. When "Infinite" is selected, a "D" appears in channel information section on the screen. Refer to the "Channel Information" explanation in chapter 4 of this manual.

5-61 Holding Measurement Data in the Currently Active Channel

1. Press the **Channel** hard key followed by the [More] soft key.
2. Press the [Meas Hold] soft key to hold the measurement data in the currently active channel. The measurement data is not updated whilst being held in this manner. The LED on the soft key is lit green when measurement hold functionality has been enabled.

Note When measurement data is being held as described above, an "H" appears in the channel information section of the screen. Refer to the "Channel Information" explanation in chapter 4 of this manual.

5-62 Setting the Peaking Indicator

The [Peaking Indicator] soft key is only available when the measurement display for the active channel is set to "Readout". It can be used in CW or pulsed / modulated mode, but in pulsed / modulated mode, only the [Peaking Indicator] soft key measurement is used.

1. Press the **Channel** hard key followed by the [More] soft key.
2. Press the [Peaking Indicator] soft key to display the [Peak Ind] group of commands.

3. Press the [Peaking Indicator] soft key to enable the peaking indicator bar on the readout display. The green LED on the soft key is lit when this function is enabled.

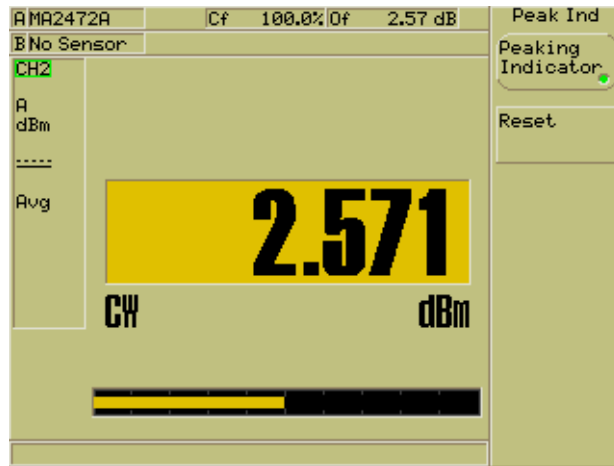

Figure 5-40. Peaking Indicator

4. Press the [Reset] soft key as required to set the indicator bar to the center of the 10 dB range with 5 dB at either side of the centralized point.

5-63 Post Processing

The post processing related soft keys allow statistical analysis or PAE of the measurement data for the currently active channel.

1. Press the **Channel** hard key followed by the [More] soft key.
2. Press the [Post Process] soft key to display the [Post Proc] group of commands.
3. Press the [Post Process] soft key to turn post processing functionality on. When post processing is enabled, the LED on the soft key is lit green and statistical or PAE information displays in the section of the screen that is normally reserved for gating related information. (Refer to the screen explanation in chapter 4 of this manual.)

4. Press the [Set Up] soft key to display the [Post Processing Set Up] dialog shown below.

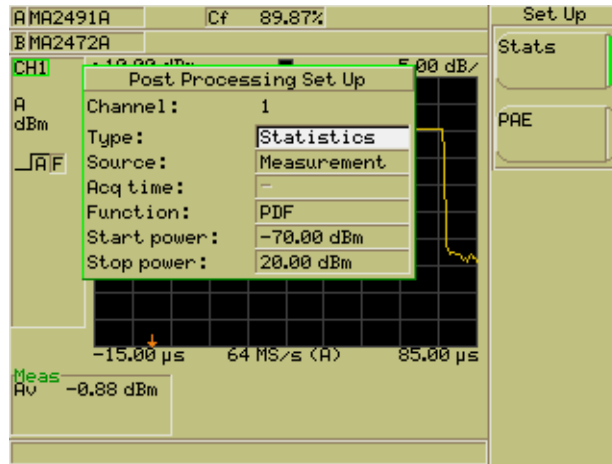

Figure 5-41. Post Processing Set Up

The [Post Processing Set Up] dialog opens with the "Type" item pre-selected. There are two options available at this item, the meanings of which are detailed in the table below. Select the required setting.

Table 5-13. Post Processing Options

Setting	Meaning
Stats	Used to display statistical analysis of the measurement data.
PAE	Used for measuring the power added efficiency of amplifiers.

5-64 Statistical Post Processing

1. Select the "Type" item in the [Post Processing Set Up] dialog and press the [Stats] soft key.
2. Press the down arrow on the numeric keypad to select the "Source" item. There are three options available at this item, the meanings of which are detailed in the table below. Select the required setting.

Table 5-14. Post Processing

Setting	Meaning
Meas	This sets the source for post processing to be the average of the data acquired over the capture time of the measurement.
Active Gate	This sets the source for post processing to be the average of the data within the active measurement gate. A measurement gate must be activated to enable this key.
Active Marker	This sets the source for post processing to be the data at the active marker position. The active marker must be displayed to enable this key.

3. Press the down arrow on the numeric keypad to select the "Function" item. Again, there are three options available at this item, the meanings of which are detailed in the table below. Select the required setting.

Table 5-15. Post Processing Function

Setting	Meaning
PDF	<p>Applies a Probability Density Function to the data, displaying a plot of percentage of samples against possible measurement values.</p> 

Table 5-15. Post Processing Function

Setting	Meaning
CDF	<p>Applies a Cumulative Density Function to the data, displaying a plot of the percentage of samples in which measurements lie at or below a given value.</p> 
CCDF	<p>Applies a Complementary Cumulative Density Function to the data, displaying a plot of the percentage of samples in which measurements lie at or above a given value.</p> 

4. Press the down arrow on the numeric keypad to select the "Start Power" and "Stop Power" items. Use the [Inc] and [Dec] soft keys or the numeric keypad to enter a start and stop power value over which the selected data will be plotted.

5-65 PAE Post Processing

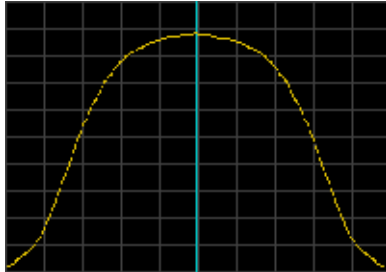
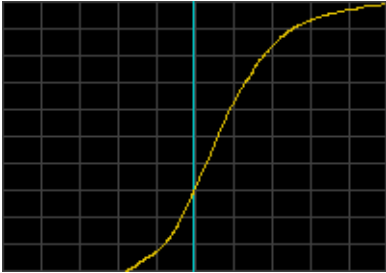
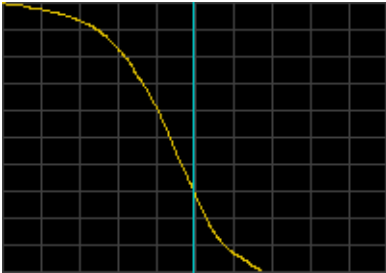
The PAE setting is available on the ML2488B and ML2496A only. It allows the user to display the power added efficiency of an amplifier connected to the sensors on the A and B inputs on the front of the power meter. Once set up and enabled, PAE is calculated and displayed automatically using the formula detailed below.

$$\left(\frac{\text{Linear output power} - \text{Linear input power}}{\text{Bias voltage} \times \text{Bias current}} \right) \times 100\%$$

1. Select the "Type" item in the [Post Processing Set Up] dialog and press the [PAE] soft key.

2. Press the down arrow on the numeric keypad to select the "Source" item. There are three options available at this item, the meanings of which are detailed in the table below. Select the required setting.

Table 5-16. PAE

Setting	Meaning
Meas	This sets the source for post processing to be the average of the data acquired over the capture time of the measurement.
Active Gate	This sets the source for post processing to be the average of the data within the active measurement gate. A measurement gate must be activated to enable this key.
Active Marker	This sets the source for post processing to be the data at the active marker position. The active marker must be displayed to enable this key.

3. Press the down arrow on the numeric keypad to select the "Input config" item. Select either [A-B] or [B-A] depending on the connector configuration in use.
4. Press the down arrow on the numeric keypad to select the "Bias voltage" item. Specify the voltage being applied to the amplifier by pressing the [Inc] and [Dec] soft keys, or by pressing [Sel] and then entering a number at the keypad.
5. Press the down arrow on the numeric keypad to select the "Current source" item. There are two options available at this item, the meanings of which are detailed in the table below. Select the required setting.

Table 5-17. Current Source

Setting	Meaning
Fixed	Select this setting if the current of the amplifier is fixed. When the [Fixed] soft key is pressed, the final item in the [Post Processing Set Up] dialog box changes to "Bias current". Select this item and enter the current in the normal manner.
Probe	Select this setting when using a current probe on the V/GHz input on the rear of the ML2488B to measure the voltage of the amplifier. When the [Probe] soft key is pressed, the final item in the [Post Processing Set Up] dialog box changes to "Conv factor". Select this item and enter the conversion factor that will be used to convert the acquired voltage to a current.

6. Press the [Exit] hard key to close the dialog and display the PAE percentage reading. The PAE display can be turned on and off by pressing the [Post Process] soft key.

Note When PAE is enabled, the input configuration of the ML2488B / ML2496A is automatically set to "A-B". This configuration is maintained even when PAE is subsequently disabled and as a result, trace and redout data will be unavailable if only one sensor is attached at this time. The input configuration can be reset as required by selecting the following sequence of commands, **Channel > [Set Up] > "Input config"**.

5-66 Setting the Cursor Position

With the post processing set-up complete as described above and the selected plot being displayed, the user can now position the cursor as described below.

1. Press the **Channel** hard key followed by the [More] soft key.
2. Press the [Post Process] soft key to display the [Post Proc] group of commands.
3. Press the [Cursor] soft key to display the [Cursor] group of commands.
4. Press the [Set Cursor Position] soft key and enter the required position using the [Inc] and [Dec] soft keys or the numeric keypad.

5-67 Zooming In or Out on the Cursor Position

1. Press the **Channel** hard key followed by the [More] soft key.
2. Press the [Post Process] soft key to display the [Post Proc] group of commands.
3. Press the [Cursor] soft key to display the [Cursor] group of commands.
4. Press the [Zoom In] or the [Zoom Out] soft key to redraw the trace centered on the cursor position.

Chapter 6 — Sensor Menu Reference

6-1 Setting Up the Sensor in Use

1. Press the **Sensor** hard key and then the [Set Up] soft key to display the [Sensor Set Up] dialog.

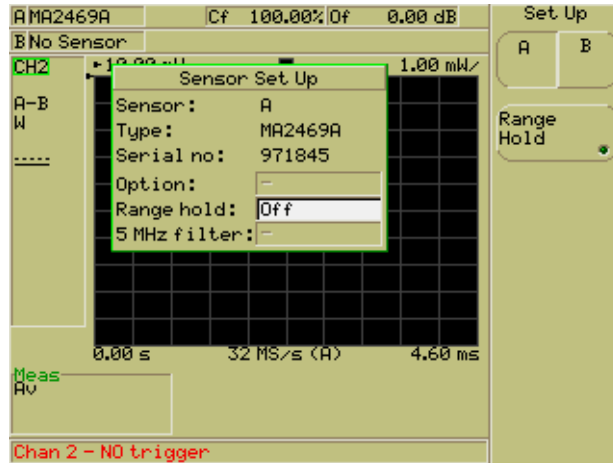

Figure 6-1. Sensor Set Up

2. The first three items within the [Sensor Set Up] dialog provide details of the current sensor configuration. The "Sensor" item gives the name of the sensor input that is currently selected. The "Type" item gives the type of sensor attached to the currently selected input. The "Serial no" item gives the serial number of the attached sensor.
3. Check that the "Sensor" item is displaying the correct input, and if not, press the [A/B] soft key to change the input as required.
4. Use the down arrow on the numeric keypad to select the "Range Hold" item. This field is used to hold the sensor attached to the input to a specified range. Enter the range by pressing [Sel] and entering a value in the normal manner.
5. Press the [Range Hold] soft key to enable range holding for the selected sensor. When enabled, the most recent range value is used and displayed in the "Range Hold" entry field.
6. Press the down arrow on the numeric keypad to select the "5 MHz filter" item. This field is available only when a wideband sensor (MA2490A, MA2491A) is attached to the specified input. Press the soft key to turn the filter on or off as required.
7. Press the [Exit] key on the keypad to close the [Sensor Set Up] dialog and revert to the previous page of commands.

6-2 Setting the Calibration Factor Applied to the Sensor

1. Press the **Sensor** hard key and then the [Cal Factor] soft key to display the [Cal Factor] dialog.

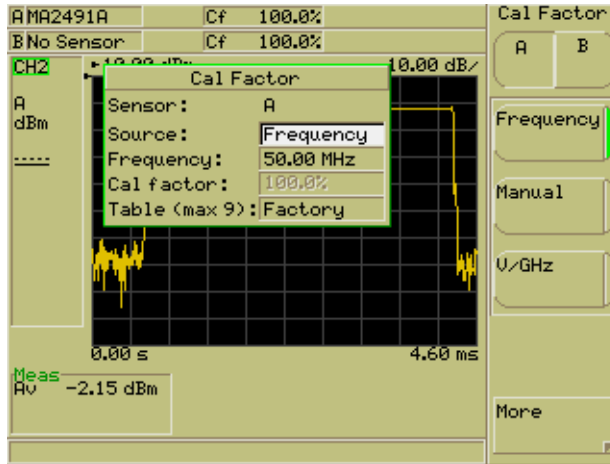

Figure 6-2. Cal Factor Source

2. Check that the sensor input displayed at the "Sensor" item in the dialog is correct. The sensor input can be changed by pressing the [A/B] soft key.
3. Use the soft keys to select the source of the calibration factor to be used for the selected sensor. Refer to the table below.

Table 6-1. Cal Factor Source

Setting	Meaning
Frequency	Correction data is read from the EEPROM in the sensor and applied automatically to the measurement based on the user's input frequency.
Manual	A user-entered value is used for the correction data.
V/GHz	Correction data is read from the EEPROM in the sensor and applied automatically to the measurement based on a frequency derived from the voltage present on the rear panel input connector. This key is unavailable if either measurement channel is using the external voltage as its input configuration.

4. Press the down arrow on the numeric keypad to select the "Frequency" entry field. This item is used to select the input signal frequency to be used when the calibration factor source mode is set to either "Frequency" or "Manual". If the "Source" item is set to "V/GHz" jump to step 7 in this procedure.
5. Enter a frequency value using the [Inc] and [Dec] soft keys, or at the numeric keypad in the normal manner.

6. Press the down arrow on the numeric keypad to select the "Cal Factor" entry field. This sets the calibration factor to be applied when the source mode is set to "Manual". Enter a percentage or dB calibration factor value using the [Inc] and [Dec] soft keys, or at the numeric keypad in the normal manner. If the "Source" item is not set to "Manual" jump to step 7 in this procedure.
7. Press the down arrow on the numeric keypad to select the last item in the [Cal Factor] dialog. This item differs depending on the setting at the "Source item".
 "Source" = "Frequency" or "V/GHz"
8. If "Source" is set to "Frequency" or "V/GHz", the "Table (max x)" item displays. This item is used to select the calibration factor table to be used with the sensor attached to the selected input. Press [Sel] on the keypad to display the [Table Id] group of commands as detailed below.

Table 6-2. Calibration Factor

Item	Meaning
Enter	The user can select any table that they have previously created and saved. Enter the number of the required table at the keypad and press [Enter] when complete.
Factory	Press the [Factory] soft key instead of entering a table number from the keypad. The calibration table supplied from the factory is used.
Factory +	Enter the number of the required table at the keypad and then press [Factory +] to use the factory supplied calibration factor table in combination with the currently selected table.

Note The maximum number of tables available displays in parenthesis after the word "Table". If the user specifies a completely blank table that has never been used, a message displays requesting that the table be either cleared or preset to the factory data. Refer to Editing Cal Factor Tables later in this chapter for details of how to edit and create user cal factor tables as mentioned above.

"Source" = "Manual"

If "Source" is set to "Manual", the "Cal adjust" item displays as the last item in the [Cal Factor] dialog. Enter a percentage or dB adjustment value at the keyboard in the normal manner.

6-3 Setting the Power Offset Applied to the Sensors

A power offset can be applied to the sensor in the manner described below.

1. Press the **Sensor** hard key and then the [Offset] soft key to display the [Offset] dialog.
2. Check that the correct sensor (A or B) is selected.

- The dialog opens with the "Type" field pre-selected for user entry. Select the offset type required from the soft keys as detailed below.

Table 6-3. Offset Types

Item	Meaning
Off	No offset is applied to the sensor. This is the default setting.
Fixed	A fixed value specified by the user is applied to the sensor. Press the down arrow on the keypad to select the "Offset" item in the dialog and then enter the offset using the [Inc] and [Dec] soft keys, or at the numeric keypad in the normal manner.
Table	The offset value applied is derived from the table that the user has selected. When "Table" is selected the "Table" item is enabled in the dialog, enabling the user to enter a table number from the keypad or press [Select Table] and make a selection from the dialog. Refer to Editing the Sensor Offset Tables later in this chapter.

Note

A positive offset adds a value to the power readings and can be used to compensate for attenuators, couplers, limiters, and other lossy devices. A negative value subtracts a value from the power reading and can be used to compensate for amplification in the measurement path.

6-4 Editing Cal Factor Tables

This section explains how to edit or create cal factor tables as mentioned in the section titled, Setting the Calibration Factor Applied to the Sensor earlier in this chapter.

- Press the **Sensor** hard key followed by the [Edit Tables] and [Edit CF Table] soft keys to display the [Edit Cal Factor Table] dialog.

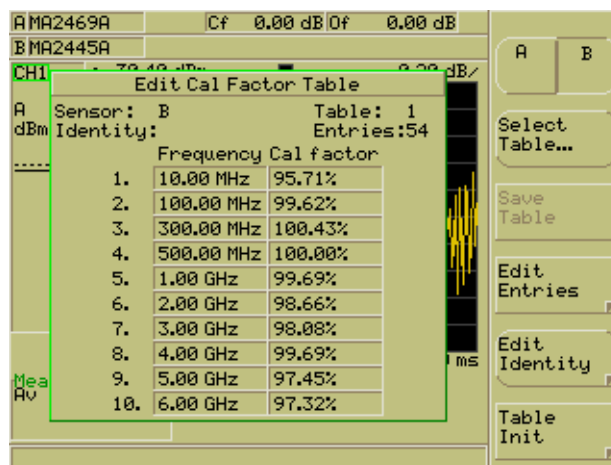

Figure 6-3. Edit Cal Factor Table

2. The table number is indicated in the top right hand corner of the dialog. If the table is not correct, press the [Select Table] soft key and enter the required table number from the keypad in the normal manner.
3. Press the [Edit Entries] soft key to highlight the upper left cell in the table. Use the arrow keys on the keypad to select the cell to be changed, press [Sel] and enter a new value in the normal manner. The soft keys that display when the [Edit Cal Factor Table] is open allow the user to navigate between cells and page the list up and down.

Note	To clear a table completely, press [Table Init] followed by [Clear Table]. All data in the table is cleared except for the first line. The [Preset Table] command that also displays on this page can be used to set the table in question to the factory default setting.
-------------	--

4. When editing is complete, press [Back] and then press the [Save Table] soft key to save the changes made.

6-5 Creating New Cal Factor Tables

1. Press the **Sensor** hard key followed by the [Edit Tables] and [Edit CF Table] soft keys to display the [Edit Cal Factor Table] dialog.
2. Press the [Select Table] soft key and enter a number from the keypad of one of the available blank tables. If no blank tables are available, the user can select a table that is no longer required and clear all entries in that table by pressing the [Table Init] soft key followed by [Clear Table].

Note	As the tables are stored within the sensor itself rather than the ML248xB / ML249xA, the number of tables available to the user varies depending on the sensor model. When the [Select Table] soft key is pressed, the maximum number of tables available displays in parenthesis in the [Select Table] dialog. This information can also be seen in the [Cal Factor] dialog when the "Source" item is set to "Frequency" or "V/GHz".
-------------	---

- Press the [Edit Entries] soft key followed by [Add Entry] to highlight the uppermost cell in the "Frequency" column of the table. Enter a value from the keypad in the normal manner and then use the arrows on the keypad to select the adjacent "Cal Factor" cell.

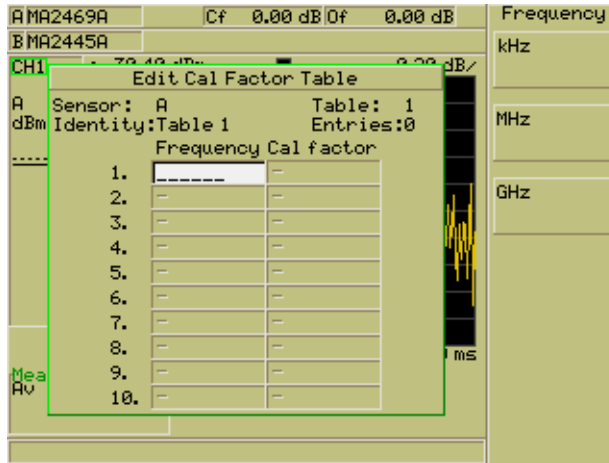

Figure 6-4. Cal Factor Table

- When a cal factor value has been entered, press the [Add Entry] soft key again to move to the next row and repeat this process until all the required entries have been made.

Note

The maximum number of entries that can be made in each table is again determined by the frequency range of the sensor in use. Sensors of up to 40 GHz can have up to 90 entries in each table, 50 GHz sensors can have up to 110 entries, and 65 GHz sensors can have up to 130 entries.

- Press the [Back] key on the keypad to display the previous page of soft keys, and press [Save Table] to save the entries in the new table.
- The table can also be given a name by pressing the [Edit Identity] soft key and entering a name from the keypad in the normal manner. When specified, the table name displays in the [Edit Cal Factor Table] dialog to the right of the word "Identity".

6-6 Editing the Sensor Offset Tables

This function is used to edit the offset tables stored in the instrument.

1. Press the **Sensor** hard key followed by the [Edit Tables] and [Edit Offset Tbl] soft keys to display the [Edit Offset Table] dialog shown below.

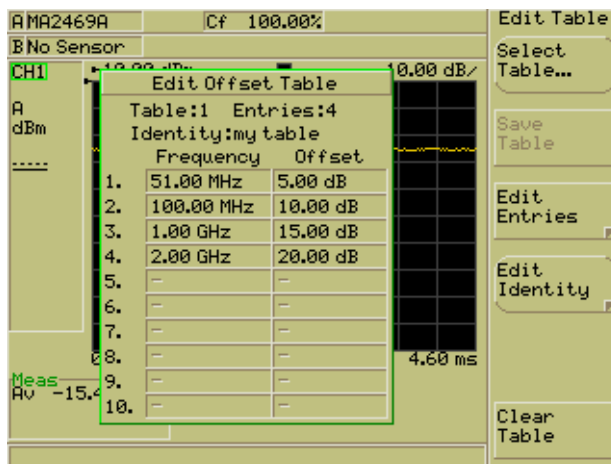

Figure 6-5. Sensor Offset Table

2. The table number and the number of entries in it are indicated on the top line of the dialog. If the table is not correct, press the [Select Table] soft key and select the required table from the list in the normal manner.
3. Press the [Edit Entries] soft key to highlight the upper left cell in the table. Use the arrow keys on the keypad to select the cell to be changed, press [Sel] and enter a new value in the normal manner. The soft keys that display when the [Edit Offset Table] is open allow the user to navigate between cells and page the list up and down.

Note To clear a table completely, press [Clear Table]. All data in the table is cleared.

4. When editing is complete, press [Back] on the numeric keypad and then press the [Save Table] soft key to save the changes made.

6-7 Creating New Sensor Offset Tables

New offset tables can be created by following the procedure below.

1. Press the **Sensor** hard key followed by the [Edit Tables] and [Edit Offset Tbl] soft keys to display the [Edit Offset Table] dialog.
2. Press the [Select Table] soft key and enter a number from the keypad of one of the available blank tables. If no blank tables are available, the user can select a table that is no longer required and clear all entries in that table by pressing the [Clear Table] soft key.

- Press the [Edit Entries] soft key followed by [Add Entry] to highlight the uppermost cell in the "Frequency" column of the table. Enter a value from the keypad in the normal manner and then use the arrows on the keypad to select the adjacent "Offset" cell.

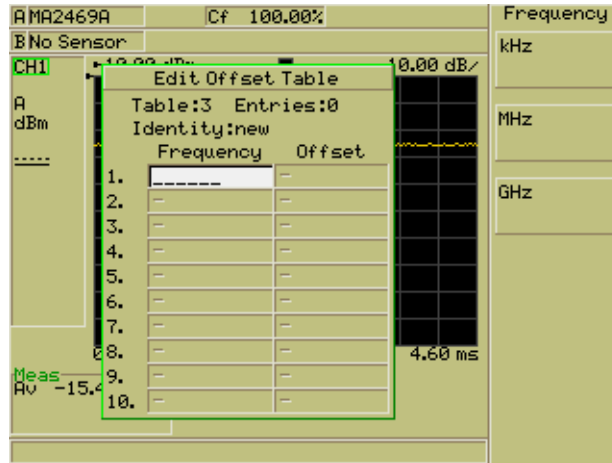

Figure 6-6. Sensor Offset Table

- When an offset value has been entered, press the [Add Entry] soft key again to move to the next row and repeat this process until all the required entries have been made.

Note Up to 200 entries can be made in each table.

- Press the [Back] key on the keypad to display the previous page of soft keys, and press [Save Table] to save the entries in the new table.
- The table can also be given a name by pressing the [Edit Identity] soft key and entering a name from the keypad in the normal manner. When specified, the table name displays at the table item in the [Offset] dialog after pressing **Sensor** followed by [Offset].

Note A positive offset adds a value to the power readings and a negative value subtracts a value from the power reading.

6-8 Holding Sensors on the Current Range

1. Press the **Sensor** hard key and then the [Range Hold] soft key.

If the sensors are auto-ranging when the soft key is pressed, the sensors are held on their current range. If the power meter is an ML2488B and one sensor is currently held on a range, pressing [Range Hold] will cause the other sensor to be held to its current range as well. If range hold is already enabled for both sensors, pressing [Range Hold] will set them back to auto-ranging. The LED on the soft key is lit green when a sensor range is being held.

Typical range hold values for the MA2472B power sensor and the MA2491A wideband sensor are shown in the table below.

Table 6-4. Range Hold Values

Mode	Range		MA2472B	MA2491A
CW	1	top	+20dBm	+20dBm
		bottom	-13	-7
	2	top	-12	-6
		bottom	-27	-20
	3	top	-25	-19
		bottom	-43	-36
	4	top	-42	-35
		bottom	-58	-53
	5	top	-57	-52
		bottom	-72	-67
	6	top bottom	Reserved for "True RMS" sensors.	
Pulsed/ Modulated	7	top	20	20
		bottom	0	5
	8	top	1	6
		bottom	-13	-8
	9	top	-12	-7
		bottom	-34	-28

Note

The figures in the MA2472B column apply to all standard diode and thermal sensors.

The figures in the MA2491A column apply also to the MA2411A.

The figures in the table above were obtained with a 1GHz CW input signal.

All values are approximate and are provided for guidance only. They will vary between individual sensors, with frequency and with modulation conditions.

Ranges 7 to 9 have large overlaps in range hold to extend the range of signals with deep modulation that can be accommodated in a single range.

Chapter 7 — Cal/Zero Menu Reference

7-1 Zeroing the Sensor

Zeroing the power sensor is vital to remove any residual DC offset on the sensor/meter combination, and to minimize noise.

1. Connect the sensor to the device under test, making sure that RF is not being supplied.
2. Press the **Cal/Zero** hard key.
3. Press the [Zero] soft key followed by [Zero Sensor A] or [Zero Sensor B].

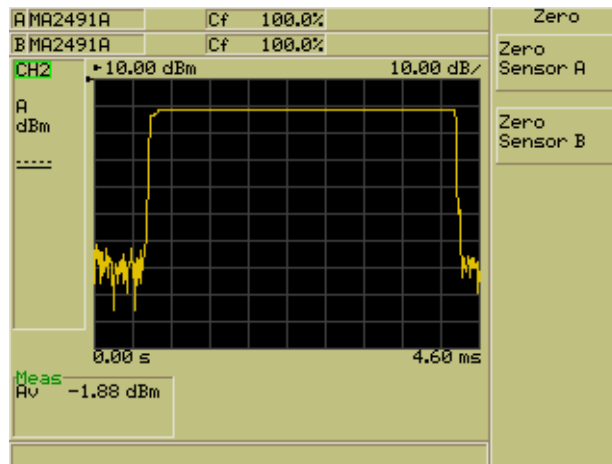

Figure 7-1. Sensor Zero

4. A dialog displays to indicate that the sensor is being zeroed and the message "Sensor x zero..." displays in the status bar at the bottom of the screen.

7-2 Zeroing and Calibrating the Sensor

1. Connect the sensor to the "CALIBRATOR" connector on the front of the ML248xB / ML249xA.
2. Press the **Cal/Zero** hard key.
3. Press the [Zero & Cal] soft key followed by [Zero & Cal Sensor A] or [Zero & Cal Sensor B].

4. A dialog displays to indicate that the sensor is being zeroed and calibrated and a message displays in the status bar at the bottom of the screen.

Note Sensor selection is not required on the ML2487B.
--

7-3 Performing a Zero dBm Calibration

1. Connect the sensor to the "Calibrator" connector on the front of the ML248xB / ML249xA.
2. Press the **Cal/Zero** hard key.
3. Press the [Cal 0 dBm] soft key to display the [Calibrate] menu.
4. Press the [Calibrate Sensor A] or the [Calibrate Sensor B] soft key.

7-4 Zeroing the Rear Panel BNC Connector

1. Press the **Cal/Zero** hard key.
2. Press the [Ext v Zero] soft key to calibrate the units to read zero volts on this BNC.

Chapter 8 — System Menu Reference

8-1 Saving Instrument Settings

The current settings can be saved to any of the instrument's twenty setting stores available.

1. Press the **System** hard key followed by the [Save/Recal] soft key.
2. Press [Save Settings] to display the [Save Settings] dialog. The dialog displays a list of the twenty setting stores, a name if one has been specified, and an indication of whether the store is currently in use.
3. Use the soft key arrows or arrows on the keypad to select any of the available stores and then press either [Save] or [Save as] to save the settings as detailed below.

Table 8-1. Save Options

Item	Meaning
Save	The current settings are saved to the selected store. If the store was previously un-used, no name is displayed for the store. If the store was already in use, the previously stored settings are automatically overwritten.
Save as...	Allows the user to set a title of up to 15 characters to the selected store before the settings are saved to it. A [Save As] dialog displays and the user can then set a name from the keyboard in the usual manner. As detailed in this chapter 4 of this manual, the [Next] soft key can be used to input consecutive letters that are both entered from the same key on the keypad. Press [Enter] to close the dialog and revert to the previous page of commands.

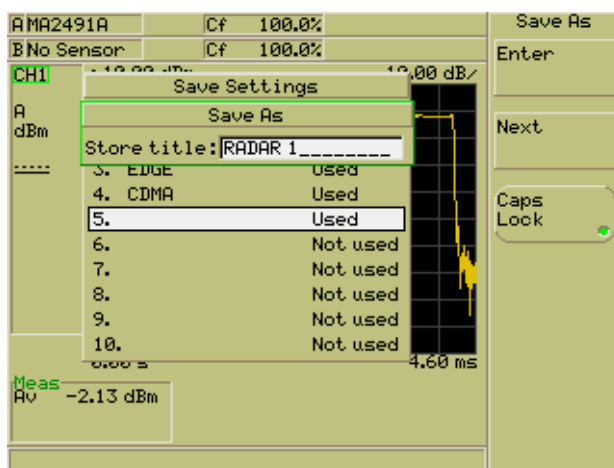

Figure 8-1. Save Settings

8-2 Recalling Instrument Settings

Any of the instrument settings that were saved in the manner described on the previous page can be recalled for use at any time.

1. Press the **System** hard key followed by the [Save/Recall] soft key.
2. Press [Recall Settings] to display the [Recall Settings] dialog. The dialog displays a list of the twenty setting stores, a name if one has been specified, and an indication of whether the store is currently in use. Press [Page Down] soft key as required to display stores 11 to 20.
3. Use the soft key arrows or arrows on the keypad to select any of the available stores and then press [Recall] to revert the unit to the saved configuration.

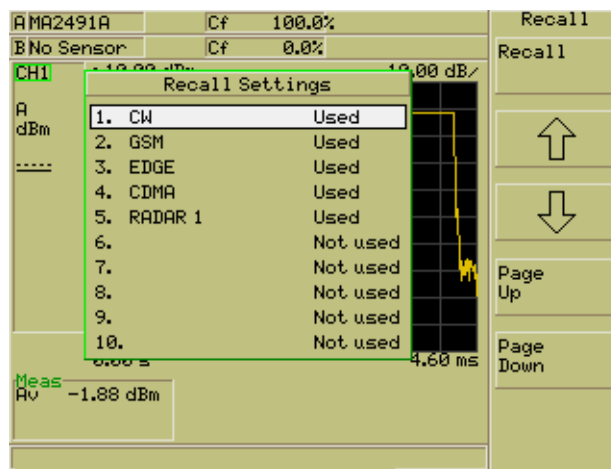

Figure 8-2. Recall Settings

8-3 Displaying and Changing the Screen Title

1. Press the **System** hard key followed by the [Config] soft key.
2. Press the [Display] soft key.

- Press the [Set Screen Title] soft key to display the [Set Screen Title] dialog where the title can be entered from the keypad. Press the [Sel] key on the keypad and then enter the required name as detailed in the "Text Entry" section in chapter 4 of this manual.

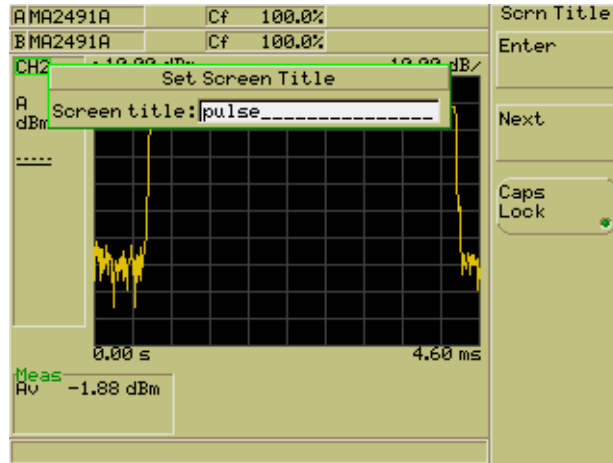
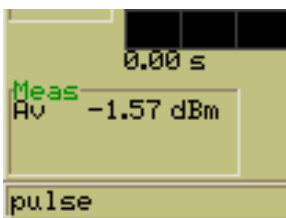

Figure 8-3. Set Screen Title

Note

The [Next] key is used to input consecutive letters that are both entered from the same key on the keypad. For example, to enter the word "EDGE", the user would press the "def" key twice to enter the "e", press the [Next] soft key, and then press the "def" key again to enter the following "d".

- Press the [Enter] soft key when entry is complete and then press [Exit] on the keypad to close the dialog.
- If screen titles have been enabled for viewing, the specified title now displays in the tool bar at the bottom of the display.



If the title does not appear, press the [Screen Title] soft key to turn the display of the screen title on. The LED on the soft key is lit green when the titles are set to on.

8-4 Capturing the Screen Image

The screen on the ML248xB / ML249xA can be captured as a bitmap image using the "ScreenCapture.exe" program on the CD supplied with the power meter. Follow the procedure below.

1. Use a GPIB cable and card to connect the ML248xB / ML249xA to the PC in the normal manner for remote operation.
2. Copy the "ScreenCapture.exe" program from the CD to a suitable location on the PC. It can be copied to any location on the PC, but users should be aware that the screen images are also generated at the same location.
3. Press the **System** hard key followed by the [Config] soft key.
4. Press the [Display] soft key followed by the [Screen Dump Mode] soft key. The LED on the soft key is lit when screen dump mode is enabled. Pressing the [Screen Dump Mode] soft key allows the user to retain the display of the soft keys even when the unit is being operated remotely. Screen dump mode also hides the remote indicator that would otherwise appear in the status window.
5. Ensure that the GPIB address of the power meter is set to 13. The procedure for this can be found on the following page. If the power meter is not configured at this address the program will exit and an explanatory message will appear on screen.
6. Display the screen to be captured on the ML248xB / ML249xA.
7. Double click the "ScreenCapture.exe" icon on the PC to open the program as shown below.

```
-----> ANRITSU EMD LTD <-----  
  
Stingray Screen Capture Utility Program  
  
Description: Acquires a screen shot over GPIB and saves it to a  
256 colour Windows bitmap file  
  
-----  
  
Connect the Power Meter to GPIB and press any key to continue:  
  
Initialising Communication with Instrument. Please wait...  
  
Number of Instruments found: 1  
Instrument 1 Primary Address: 13  
Secondary Address: NONE  
  
1) Acquire Screen Image  
2) Exit Program  
Please Select Entry: █
```

Figure 8-4. Screen Capture

8. Press any key to continue, and then press [1] followed by [Enter].
9. Enter a name for the bitmap image followed by the extension ".bmp". For successful generation, the file name must not exceed 8 characters in length.
10. The image is generated at the same location as the "ScreenCapture.exe" file.

8-5 Changing the Brightness of the Display Backlight

1. Press the **System** hard key followed by the [Config] soft key.
2. Press the [Display] soft key.
3. Press the [Backlight] soft key.

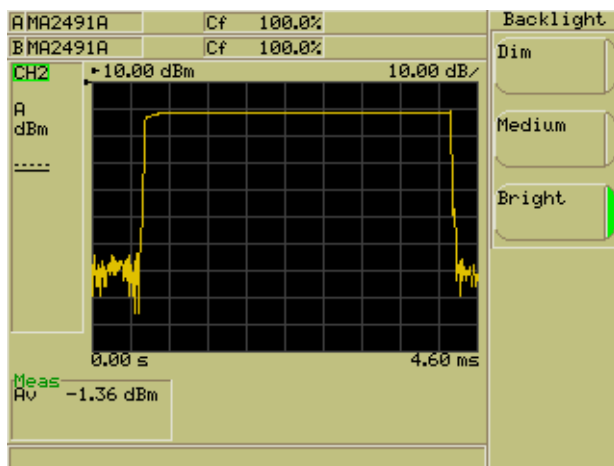

Figure 8-5. Backlight

1. Use the soft keys to select the level of lighting required.

8-6 Setting the GPIB Address for the Instrument

1. Press the **System** hard key followed by the [Config] soft key.
2. Press the [Remote] soft key.

3. Press the [Set GPIB Address] soft key display the [Set GPIB Address] dialog.

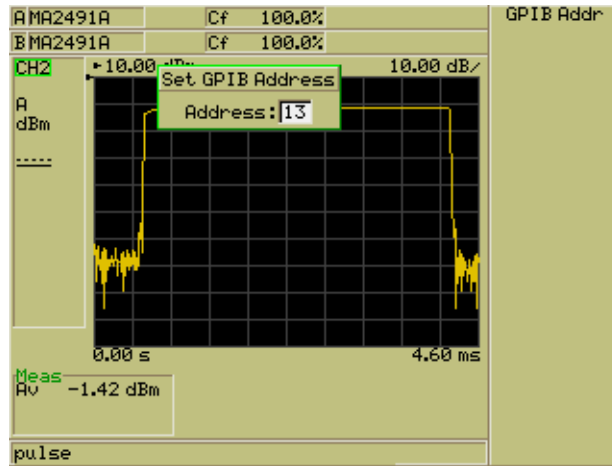

Figure 8-6. GPIB Address

4. Enter the GPIB address at the numeric keypad in the usual manner.

8-7 Enabling Buffering of the GPIB Output

1. Press the **System** hard key followed by the [Config] soft key.
2. Press the [Remote] soft key.
3. Press the [GPIB O/p Buffering] soft key to enable buffering of the GPIB output. The LED on the soft key is lit green when buffering is enabled.

8-8 Setting the RS232 Serial Port Baud Rate

1. Press the **System** hard key followed by the [Config] soft key.
2. Press the [Remote] soft key.
3. Press the [Set RS232 Baud Rate] soft key to display the [Baud Rate] dialog.
4. Use the up and down arrows on the soft keys or on the numeric keypad to select the required baud rate.

5. When the required rate has been selected, press the [Set Baud Rate] soft key to enable the selected rate. The LED to the right of the setting is lit green to indicate that the setting is enabled.



Figure 8-7. Baud Rate

8-9 Setting the LAN IP Address

1. Press the **System** hard key followed by the [Config] soft key.
2. Press the [Remote] soft key.
3. Press [LAN Reset Auto] to have the IP address assigned automatically by a DHCP server, or press LAN Reset Manual to use a static IP address. The default IP address is 192.168.0.2 although this can be by pressing [Manual LAN Settings].

8-10 Setting the Static IP Address

1. Press the **System** hard key followed by the [Config] soft key.
2. Press the [Remote] soft key.
3. Press the [Manual LAN Settings] soft key to display the [Manual LAN Settings] dialog.
4. Enter the address at the numeric keypad in the usual manner.
5. The address entered is used as the default setting when the user presses [LAN Reset Manual] to set a static IP address.

8-11 Configuring the Rear Panel Outputs

1. Press the **System** hard key followed by the [Config] soft key.
2. Press the Rear Panel [Config] soft key to display the [Rear Panel Configuration] dialog. The dialog is split into two halves; the upper half for port 1 and the lower for port 2.

When the settings for one side are complete, press the [O/P 1/2] soft key to switch between outputs.

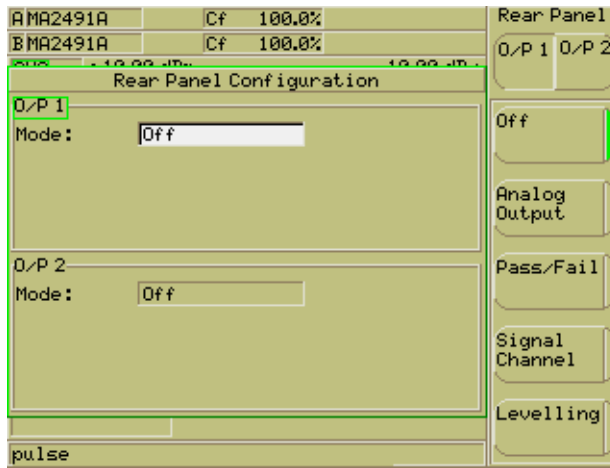

Figure 8-8. Rear Panel Outputs

Use the soft keys to change the "Mode" setting as required. There are five options available as detailed in the table below.

Table 8-2. Mode Settings

Setting	Meaning
Off	Sets the output of the port to ground.
Analog Output	Sets the port to provide a voltage proportional to the measurement in the selected measurement channel. (CW mode)
Pass/Fail	Sets the port to provide a logic level output dependent upon the result of the limit checking of the selected measurement channel.
Levelling	Used to set the port to provide an output from either range 1 or range 2 of the signal channel associated with the port. The port association is the same as for the 'Signal Channel' mode.
Trigger Out (ML249xA only)	Used to set Output 2 for trigger out. Rise time is 2 μ s.

The items that display for each port differ depending on the "Mode" setting selected. The settings available are summarized in the table below.

Table 8-3. Port Setting Items

Off	Analog Output	Pass/Fail	Signal Channel	Levelling
—	Channel	Channel	Sensor	Sensor

Table 8-3. Port Setting Items

Off	Analog Output	Pass/Fail	Signal Channel	Levelling
—	Start / Stop voltage	Pass Level	—	Range
—	Start / Stop power.	—	—	—

If "Mode" is set to "Analog Output":

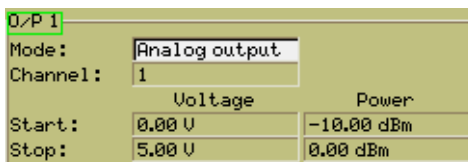

Figure 8-9. Analog Output

- a. Use the down arrow on the numeric keypad to select the "channel" item and then use the soft keys to select measurement channel 1 or 2.
- b. Use the down arrow on the numeric keypad to select the "Start" / "Voltage" entry field. Enter the start and stop voltages used to derive the output voltage proportional to the measurement. The voltages are entered using the [Inc] and [Dec] soft keys, or at the numeric keypad in the normal manner.
- c. Use the right arrow on the numeric keypad to select the "Start" / "Power" entry field. Enter the start and stop powers used to derive the output voltage proportional to the measurement. The powers are entered using the [Inc] and [Dec] soft keys, or at the numeric keypad in the normal manner.

If "Mode" is set to "Pass/Fail":

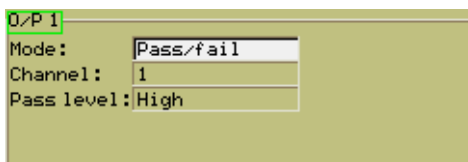

Figure 8-10. Pass/Fail

- a. Use the down arrow on the numeric keypad to select the "channel" item and then use the soft keys to select measurement channel 1 or 2.
- b. Use the down arrow on the numeric keypad to select the "Pass level" entry field. Use the soft keys to set the output signal pass level to high or to low.

If "Mode" is set to "Levelling":

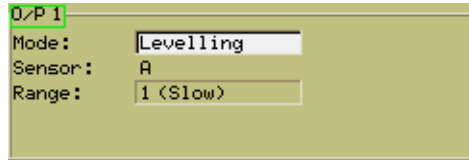

Figure 8-11. Levelling

- a. Use the down arrow on the numeric keypad to select the "Range" item and then use the soft keys to select the input range of the sensor input associated with the BNC port.

8-12 Turning the Key Click On or Off

1. Press the **System** hard key followed by the [Config] soft key.
2. Press the [Key Click] soft key. The LED on the soft key is lit green when the key click is turned on.

8-13 Setting Increment and Decrement Steps

The amount by which a numeric entry changes when the user presses the [Inc] and [Dec] soft keys is specified for each unit of measurement as detailed below.

1. Press the **System** hard key followed by the [Config] soft key.
2. Press the [Set Inc / [Dec Steps] soft key to display the [Set Inc / Dec Steps] dialog shown below.

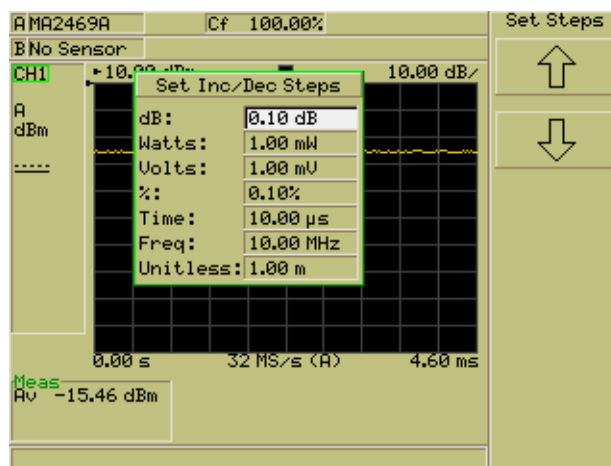

Figure 8-12. Set Increment and Decrement Steps

3. Use the soft arrow keys, or the arrow keys on the numeric keypad, to navigate between units of measurement in the dialog.
4. Press the [Sel] key and enter the required step interval from the keyboard in the usual manner.
5. Repeat this process until all items in the dialog have been corrected as required.

8-14 Viewing the Instrument Identity Dialog

1. Press the **System** hard key followed by the [Service] soft key.
2. Press the [Identity] soft key to display the [Identity] dialog with details of the instruments firmware version, serial number, and instrument type.

Identity	
Firmware version:	EE1.05.013
DSP sub-version:	200.016
FPGA sub-version:	2.68
Serial number:	6K00003361
Instrument type:	ML2496A
Hostname:	
MAC address:	000091E0030E
TCP/IP Config:	Auto (DHCP)
Dynamic DNS:	Enabled
IP Address:	172.30.1.90
Subnet Mask:	255.255.255.0
Default Gateway:	172.30.1.3
Primary DNS:	172.30.1.5

Figure 8-13. Instrument Identity

8-15 Turning the Security Feature On or Off

The security feature can be enabled to delete stores of data that may contain sensitive information that could otherwise be accessed when the unit is booted up. All information stores are cleared, together with cal factor settings, and any settings stored with the [Save] command.

1. Press the **System** hard key followed by the [Service] soft key.
2. Press the [Secure] soft key to toggle security between on and off. The LED on the soft key is lit green when security is enabled, and any sensitive information is deleted when the instrument is turned on.

8-16 Diagnostics

The [Diag] soft key in the [Service] group of commands is for use as a diagnostics tool by Anritsu employees only. A password is required to access the associated commands.

8-17 Upgrading the System Software

Software upgrades will be posted on the Anritsu website at the address given in the procedure below. To receive e-mail notification each time the software is updated, send a email to <https://www.anritsu.com/en-US/test-measurement/contact-us> with the subject heading of "ML248xB / ML249xA firmware upgrade notification".

1. Download the latest software from the Anritsu website. To do this, go to <https://www.anritsu.com/search/en-US/default?q=power%20measurement>
2. Click the software download link, save the zipped data to a local drive on the PC and unzip it as required.
3. Connect the PC com port to the serial port on the ML248xB / ML249xA using the bootload cable.
4. Power-up the ML248xB / ML249xA and press [Clr] when the self-test screen displays to commence normal operation.
5. Press the **System** hard key followed by the [Service] soft key.
6. Press [Upgrade] to display the [Upgrade Instrument] dialog.
7. Press [Continue] after checking that the serial cable is connected.
8. Open the zipped folder downloaded in step 2 and click once on the appropriate boot file to select it ("boot1" for com port 1, "boot2" for com port 2).
9. The new software is downloaded and a message displays in the dialog when download is complete.

Note	The upgrade procedure will time-out at the PC if the appropriate boot file is not selected within 10 seconds of pressing [Continue].
-------------	--

Chapter 9 — Preset Menu Reference

9-1 Resetting the System

There are two settings available to the user to return the instrument to the system set up or factory defaults. It is recommended that a preset be carried out prior to each new measurement type and whenever the meter is reconfigured for a new measurement.

1. Press the **Preset** hard key to display the [Preset] dialog shown below.



Figure 9-1. Preset

Use the arrows on the soft key menu or numeric keypad to select "Reset" or "Factory" and press the [Select] soft key. The difference between "Reset" or "Factory" is explained below.

Reset: Resets the instrument to the system set up. The offset tables and the GPIB interface are not affected. Resetting commences without further warning when the [Select] soft key is pressed with "Reset" selected.

Factory: Resets the instrument to the factory defaults. The offset tables and external interfaces are also reset. When the [Select] soft key is pressed with "Factory" selected, a [Factory Preset] dialog displays to warn the user that the offset tables and external interfaces will also be reset. The user can then select to continue or to return to the previous page.

Use the soft keys to select the preset type required and press the [Select] soft key.

9-2 Using the Preset Configurations

Preset configurations can be used to automatically configure the instrument for each of the major measurement types. For the ML248xB there are 11 presets and for the ML249xA an additional five are available (numbers 14 to 18 in the figure below).

1. Press the **Preset** hard key to display the [Preset] dialog shown below.

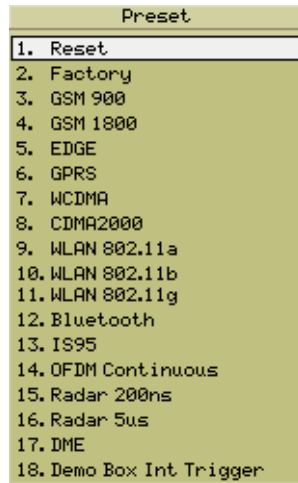

Preset
1. Reset
2. Factory
3. GSM 900
4. GSM 1800
5. EDGE
6. GPRS
7. WCDMA
8. CDMA2000
9. WLAN 802.11a
10. WLAN 802.11b
11. WLAN 802.11g
12. Bluetooth
13. IS95
14. OFDM Continuous
15. Radar 200ns
16. Radar 5us
17. DME
18. Demo Box Int Trigger

Figure 9-2. Preset Dialog

Note The figure above is a composite image showing all of the presets available. On the unit itself the dialog displays only the first ten options and the user presses the [Page Down] soft key to display options 11 to 18.

2. Use the arrows on the soft key menu or numeric keypad to select the required configuration and press the [Select] soft key.

Note Refer to [Appendix C, "Default Values and Presets"](#) for details of each of the preset settings.

Chapter 10 — Remote Operation

The ML248xB and ML249xA can be operated remotely by means of GPIB and RS232 interfaces. In addition the ML249xA power meters also support the use of Ethernet control.

10-1 Overview of GPIB

The GPIB provides a remote means to control the power meter as an alternative to using the interface on the unit itself. All commands on the ML248xB/ML249xA have an equivalent GPIB command and these can either be used simply to control the unit remotely, or in a complete GPIB program which can be used to set up multiple units to the required state, execute the required tests, and feed back the results to the PC acting as the controller. The GPIB measurement signal path is illustrated in the figure on the following page.

Refer to the "ML248xB / ML249xA Peak Power Meter Remote Programming Manual" for full details of all supported GPIB commands.

10-2 Overview of Ethernet

The Ethernet interface provided can also be used for remote control. Connection to the ML249xA Ethernet interface can be direct to a PC, or via a network (e.g., a hub). The meter is programmed using the same GPIB command set as above.

Refer to the "ML248xB / ML249xA Peak Power Meter Remote Programming Manual" for full details of Ethernet control.

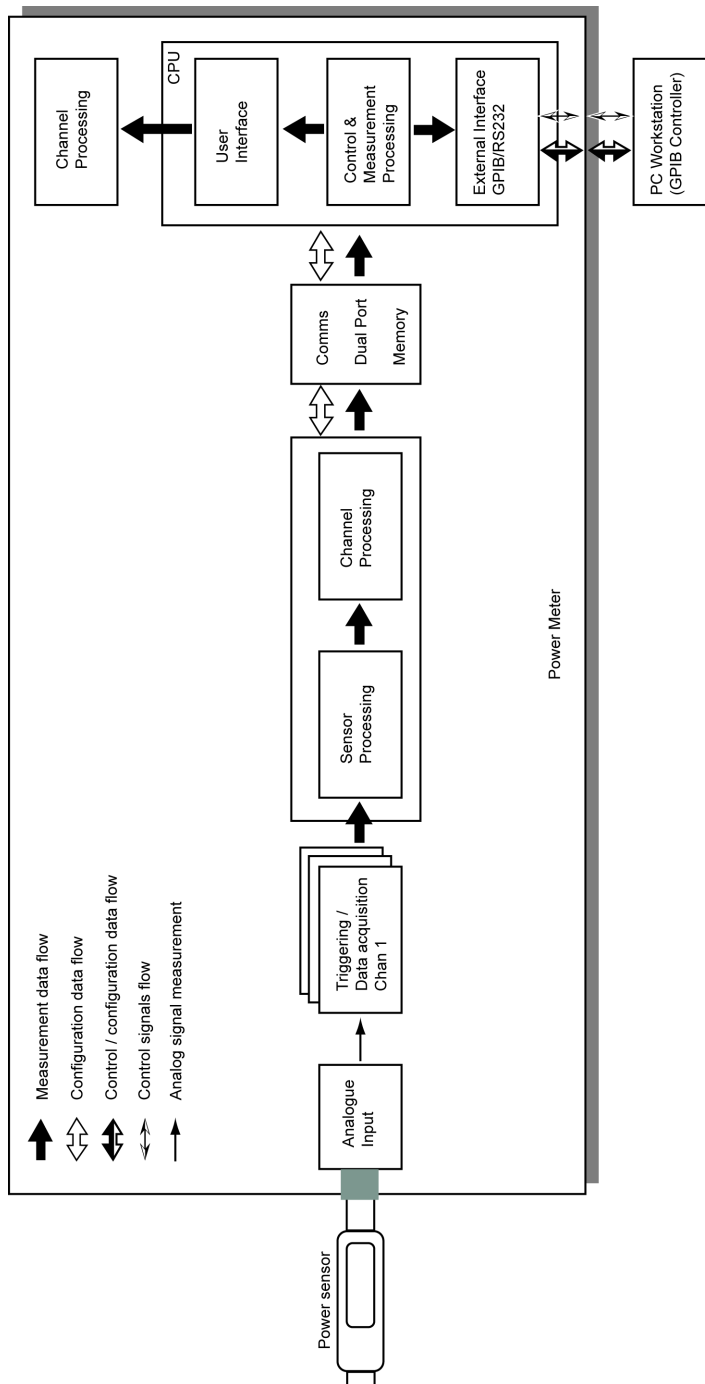

Figure 10-1. Remote Operation

Chapter 11 — CW Setup and Measurement

11-1 Setting Up the Power Meter for CW Measurements

Follow the procedure below to set up the ML248xB / ML249xA to perform continuous wave measurement.

Note	Either of the channels can be set up for CW measurement in the manner described below, but it should be noted that channel 2 is already preset for CW measurement.
-------------	--

1. Perform calibration

Connect the sensor in use to the input on the front panel.

Connect the RF port of the sensor to the "Calibrator" input on the front panel.

Press the **Cal/Zero** hard key followed by the [Zero & Cal] soft key.

Press the [Zero & Cal Sensor] soft key for the input in use. The sensor is now calibrated and a message displays on the screen when calibration is complete. Remove the sensor from the "Calibrator" input when complete.

Press the **Sensor** hard key followed by the [Cal Factor] soft key to display the [Cal Factor] dialog.

Use the soft keys to select [Frequency] at the "Source" item, and then enter the required frequency at the keypad after selecting the "Frequency" item. Correction data is read from the EEPROM in the sensor and applied automatically to the measurement based on the input frequency.

2. Set up the channel

Press the **Channel** hard key followed by the [Setup] soft key to display the [Channel Set Up] dialog. The settings required in this dialog are detailed below.

Table 11-1. Channel Set Up

Item	Required setting
Mode:	CW
Input Config:	Set to the input in use.
Units:	Select the required units. The default setting is dBm and this is suitable for CW measurement.
Resolution:	The default setting of n.nn is suitable.
Settling%:	Enter a settling percentage as required. A 1% settling time value relates to approximately 0.04 dB.

3. Set up averaging

Press the **Channel** hard key followed by the [Averaging] soft key. The averaging setting should be set to [Auto] by default and this setting is suitable for CW measurement. Averaging can also be set to either [Moving] or [Repeat] and the difference between these settings is explained in the section on common procedures.

4. Connect the RF port on the sensor to the DUT and monitor the measurement results on the screen.

Chapter 12 — GSM Setup and Measurement

12-1 Setting Up the Power Meter for GSM Measurements

Follow the procedure below to set up the ML248xB / ML249xA to perform GSM measurement.

Note The "GSM 900" or "GSM 1800" options in the [Preset] dialog can also be used to automatically configure the unit for GSM measurement. Press the Preset hard key and then use the arrow keys to select option 3 or 4.

1. Perform calibration

Connect the sensor in use to the input on the front panel.

Connect the RF port of the sensor to the "Calibrator" input on the front panel.

Press the **Cal/Zero** hard key followed by the [Zero & Cal] soft key.

Press the [Zero & Cal Sensor] soft key for the input in use. The sensor is now calibrated and a message displays on the screen when calibration is complete. Remove the sensor from the "Calibrator" input when complete.

Press the **Sensor** hard key followed by the [Cal Factor] soft key to display the [Cal Factor] dialog.

Use the soft keys to select [Frequency] at the "Source" item, and then enter the required frequency at the keypad after selecting the "Frequency" item. Correction data is read from the EEPROM in the sensor and applied automatically to the measurement based on the input frequency.

2. Select the type of measurement to be made on the data.

Press the **Channel** hard key followed by the [Set Up] soft key. Set the "Mode" item to "Pulsed / Modulated". Use the down arrow on the keypad to select the "Measurement" item and then use the soft keys to select the measurements to be made. Refer to the explanation in chapter 5 of this manual in the section titled "Selecting the Type of Measurement to be Made".

3. Set up triggering

Press the **Channel** hard key followed by the [Trigger] soft key. Use the soft keys to make the settings detailed below.

Table 12-1. Trigger Set Up

Item	Required setting
Trigger Source:	Internal A
Type:	Rising

Table 12-1. Trigger Set Up

Item	Required setting
Set Trig Level:	Use the numeric keypad to enter a value below the power level to be measured.
Arming:	Automatic.
Set Cap Time:	A GSM pulse is 577 μ s long, so the capture time should be sufficient to accommodate that, e.g., 1 ms.
Set Trig Delay:	Enter a value as required to delay the capture time with respect to the trigger event.

4. Set up the gating patterns.

Press the **Channel** hard key followed by the [Gating] soft key.

Press the [Set Up] soft key to display the [Gating Set Up] dialog. The gating settings are set up for GSM measurement by default so the user needs only to use the arrows on the numeric keypad to select the settings required and then enable each one with the [Enabled] soft key. If the default settings are not suitable they can be changed by selecting the gate in the dialog and entering a new value from the numeric keypad in the usual manner.

Press [Exit] when complete and then display the gates on screen by pressing the [Display Gates] soft key.

5. Set the display scaling.

Press the **Channel** hard key followed by the [More] soft key.

Press the [Scaling] soft key to display the [Scaling] menu.

Use the [Set Ref] and the [Set Scale] soft keys to set the level and scale as required.

6. Enter the limits as described in the "Common Procedures" section of this manual.

Press the **Channel** hard key followed by the [More] soft key.

Press the [Limit Checking] soft key to display the [Lim Check] group of commands.

Press the [Set Up] soft key to display the [Limit Checking Set Up] dialog.

Enter the limits as required.

7. Set up the markers as described in the "Common Procedures" section of this manual.

Press the **Channel** hard key followed by the [Markers] soft key.

Use the commands in the [Markers] menu to set up and display the markers as required.

8. Connect the RF port on the sensor to the DUT and monitor the measurement results on the screen.

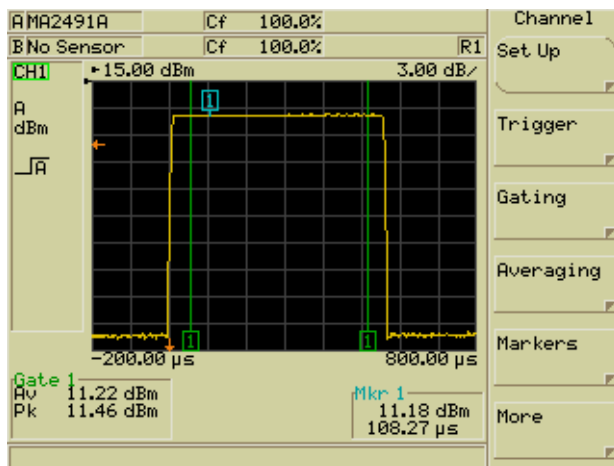

Figure 12-1. GSM

Chapter 13 — CDMA Setup and Measurement

13-1 Setting Up the Power Meter for CDMA Measurements

Follow the procedure below to set up the ML248xB / ML249xA to perform CDMA measurement.

Note The "WCDMA" option in the [Preset] dialog can also be used to automatically configure the unit for CDMA measurement. Press the [Preset] hard key and then use the arrow keys to select option 7.

1. Perform calibration

Connect the sensor in use to the input on the front panel.

Connect the RF port of the sensor to the "Calibrator" input on the front panel.

Press the **Cal/Zero** hard key followed by the [Zero & Cal] soft key.

Press the [Zero & Cal Sensor] soft key for the input in use. The sensor is now calibrated and a message displays on the screen when calibration is complete. Remove the sensor from the "Calibrator" input when complete.

Press the **Sensor** hard key followed by the [Cal Factor] soft key to display the [Cal Factor] dialog.

Use the soft keys to select [Frequency] at the "Source" item, and then enter the required frequency after selecting the "Frequency" item. Correction data is read from the EEPROM in the sensor and applied automatically to the measurement based on the input frequency.

2. Set up the channel

Press the **Channel** hard key followed by the [Setup] soft key to display the [Channel Set Up] dialog. The settings required in this dialog are detailed below.

Table 13-1. Channel Set Up

Item	Required setting
Mode:	Pulsed/Modulated
Measurement:	Select the type of measurement to be made on the data. Refer to the explanation in chapter 5 of this manual in the section titled "Selecting the Type of Measurement to be Made".
Meas display:	Readout

3. Set the triggering source.

Press the **Channel** hard key followed by the [Trigger] soft key to display the [Trigger] group of commands.

Press the [Trigger Source] soft key and select [Cont].

4. Set the time over which the measurement is taken.
5. Connect the RF port on the sensor to the DUT and monitor the measurement results on the screen as shown in the figure below.

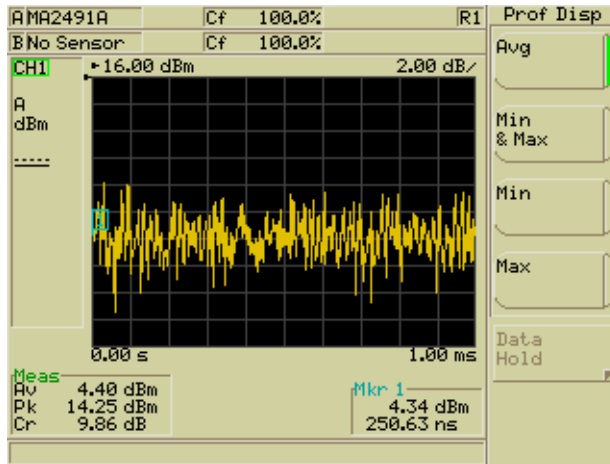

Figure 13-1. CDMA

Chapter 14 — EDGE Setup and Measurement

14-1 Setting Up the Power Meter for EDGE Measurements

Follow the procedure below to set up the ML248xB / ML249xA to perform EDGE measurement.

Note The "EDGE" option in the [Preset] dialog can also be used to automatically configure the unit for EDGE measurement. Press the **Preset** hard key and then use the arrow keys to select option 5.

1. Perform calibration

Connect the sensor in use to the input on the front panel.

Connect the RF port of the sensor to the "Calibrator" input on the front panel.

Press the **Cal/Zero** hard key followed by the [Zero & Cal] soft key.

Press the [Zero & Cal Sensor] soft key for the input in use. The sensor is now calibrated and a message displays on the screen when calibration is complete. Remove the sensor from the "Calibrator" input when complete.

Press the **Sensor** hard key followed by the [Cal Factor] soft key to display the [Cal Factor] dialog.

Use the soft keys to select [Frequency] at the "Source" item, and then enter the required frequency after selecting the "Frequency" item. Correction data is read from the EEPROM in the sensor and applied automatically to the measurement based on the input frequency.

2. Select the type of measurement to be made on the data.

Press the **Channel** hard key followed by the [Set Up] soft key. Use the down arrow on the keypad to select the "Measurement" item and then use the soft keys to select the measurements to be made. Refer to the explanation in chapter 5 of this manual in the section titled "Selecting the Type of Measurement to be Made".

3. Set up triggering

Press the **Channel** hard key followed by the [Trigger] soft key. Use the soft keys within the trigger menu to make the settings detailed below.

Table 14-1. Trigger Set Up

Item	Required setting
Trigger Source:	Internal A
Type:	Rising
Set Trig Level:	Use the numeric keypad to enter a value below the power level to be measured.

Table 14-1. Trigger Set Up

Item	Required setting
Arming:	Automatic.
Set Cap Time	An EDGE pulse is 577 μ s long, so the capture time should be sufficient to accommodate that, e.g., 1 ms.
Set Trig Delay:	Enter a value as required to delay the capture time with respect to the trigger event.
Hold off:	Set to a value to match the length of the burst or slightly longer.

4. Set up the gating and fence patterns.

Press the **Channel** hard key followed by the [Gating] soft key.

Press the [Set Up] soft key to display the [Gating Set Up] dialog. The gating settings are set up for GSM measurement by default and these can also be used for EDGE. The user needs only to use the arrows on the numeric keypad to select the settings required and then enable each one with the [Enabled] soft key. If the default settings are not suitable they can be changed by selecting the gate in the dialog and entering a new value from the numeric keypad in the usual manner. For EDGE measurements the user may wish to set a fence in the middle of the gate to exclude the measurements results from the mid-burst training sequence.

Press [Exit] when complete and then display the gates on screen by pressing the [Display Gates] soft key.

5. Set the display scaling.

Press the **Channel** hard key followed by the [More] soft key.

Press the [Scaling] soft key to display the [Scaling] menu.

Use the [Set Ref] and the [Set Scale] soft keys to set the level and scale as required.

6. Enter the limits as described in the "Common Procedures" section of this manual.

Press the **Channel** hard key followed by the [More] soft key.

Press the [Limit Checking] soft key to display the [Lim Check] group of commands.

Press the [Set Up] soft key to display the [Limit Checking Set Up] dialog.

Enter the limits as required.

7. Set up the markers as described in the "Common Procedures" section of this manual.

Press the **Channel** hard key followed by the [Markers] soft key.

Use the commands in the [Markers] menu to set up and display the markers as required.

8. Connect the RF port on the sensor to the DUT and monitor the measurement results on the screen.

EDGE Setup and Measurement Setting Up the Power Meter for EDGE Measurements

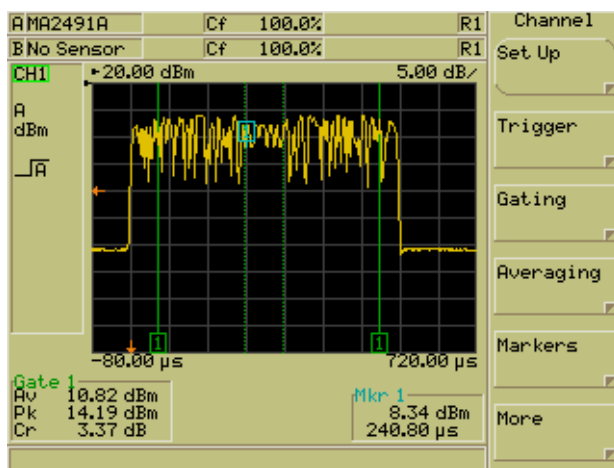

Figure 14-1. EDGE

Chapter 15 — WLAN Setup and Measurement

15-1 Setting Up the Power Meter for WLAN Measurements

Follow the procedure below to set up the ML248xB / ML249xA to perform WLAN measurement.

Note The "WLAN" options in the [Preset] dialog can also be used to automatically configure the unit for WLAN measurement. Press the **Preset** hard key and then use the arrow keys to select option 9, 10, or 11.

15-2 802.11b, a, and g

1. Perform calibration

Connect the sensor in use to the input on the front panel.

Connect the RF port of the sensor to the "Calibrator" input on the front panel.

Press the **Cal/Zero** hard key followed by the [Zero & Cal] soft key.

Press the [Zero & Cal Sensor] soft key for the input in use. The sensor is now calibrated and a message displays on the screen when calibration is complete. Remove the sensor from the "Calibrator" input when complete.

Press the **Sensor** hard key followed by the [Cal Factor] soft key to display the [Cal Factor] dialog.

Use the soft keys to select [Frequency] at the "Source" item, select the "Frequency" item and then enter a frequency at the keypad of 2.4 GHz for 802.11b and g, or 5 ' 6 GHz for 802.11a.

2. Set up triggering

Press the **Channel** hard key followed by the [Trigger] soft key. Use the soft keys within the trigger menu to make the settings detailed below.

Table 15-1. Trigger Set Up

Item	Required setting
Trigger Source:	Internal A
Set Cap Time	Enter a value suitable to display the full pulse with both rising and falling edges. The capture time would typically be about 20% longer than the packet length.
Set Trig Delay:	Enter a value as required to delay the capture time with respect to the trigger event. A negative value must be entered to display pre-trigger information as shown in the figure at the end of this chapter.

Table 15-1. Trigger Set Up

Item	Required setting
Type:	Rising
Set Trig Level:	Enter a value below the power level to be measured. A typical value would be in the region of -5 dBm.
Arming:	Frame.
Hold off:	Off

3. Set up the gating and fence patterns.

Press the **Channel** hard key followed by the [Gating] soft key.

Press the [Set Up] soft key to display the [Gating Set Up] dialog. As shown in the figure at the bottom of this section, the user will typically require two gates. The first gate would be used to measure the training sequences at the start of the gate, e.g., 2 μs to 18 μs. The second gate would be used to measure the payload itself e.g., 30 μs to 150 μs. Make the settings required and then enable each one with the [Enabled] soft key.

Press [Exit] when complete and then display the gates on screen by pressing the [Display Gates] soft key.

4. Set the channel measurement mode to [Avg, Peak & Crest].

Press the **Channel** hard key to display the [Channel] group of commands.

Press the [Set Up] soft key to display the [Channel Set Up] dialog.

Select the "Measurement" item and select [Avg, Peak & Crest] from the soft keys.

Note

The upper limit of the operational range of the sensors used to make the power measurement is +20 dBm. This upper limit is the peak signal that the power sensor can correct. For signals with a high peak to average ratio, an attenuator is needed to keep the peak signal within the operational range of the sensor. For example, a +20 dBm average power WLAN signal with a peak of +10 dB will have peaks at +30 dBm. A 10 dB attenuator should therefore be used in front of the sensor. Apply offset correction by pressing the **Sensor** hard key followed by the [Offset] soft key.

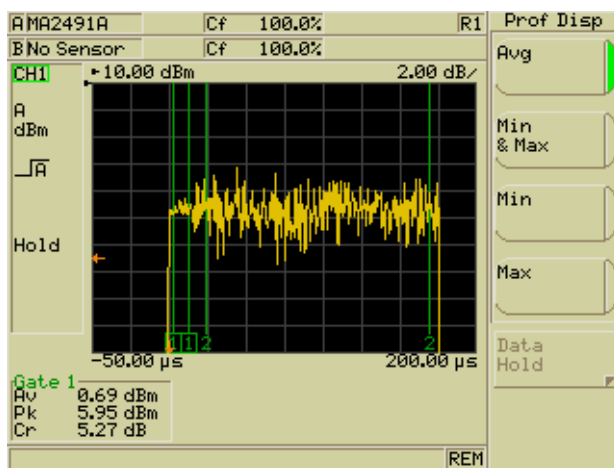

Figure 15-1. WLAN

Chapter 16 — Radar Setup and Measurement

16-1 Setting Up the Power Meter for Radar Measurements

Follow the procedure below to set up the ML248xB / ML249xA to perform Radar measurement on single pulses.

Note There are two Radar options in the [Preset] dialog which can also be used to automatically configure the unit for single pulse radar measurement. Press the **Preset** hard key and then use the arrow keys to select either option 15 Radar 200ns or option 16 Radar 5 μ s. These will set the display time up to either 200ns (RRS mode) or 5 μ s for capturing a radar pulse. Trigger is set to Internal A.

1. Perform calibration

Connect the sensor in use to the input on the front panel.

Connect the RF port of the sensor to the "Calibrator" input on the front panel.

Press the **Cal/Zero** hard key followed by the [Zero & Cal] soft key.

Press the [Zero & Cal Sensor] soft key for the input in use. The sensor is now calibrated and a message displays on the screen when calibration is complete. Remove the sensor from the "Calibrator" input when complete.

Press the **Sensor** hard key followed by the [Cal Factor] soft key to display the [Cal Factor] dialog.

Use the soft keys to select [Frequency] at the "Source" item, and then enter the required frequency after selecting the "Frequency" item. Correction data is read from the EEPROM in the sensor and applied automatically to the measurement based on the input frequency.

2. Select the type of measurement to be made on the data.

Press the **Channel** hard key followed by the [Set Up] soft key. Use the down arrow on the keypad to select the "Measurement" item and then use the soft keys to select the measurements to be made. Refer to the explanation in chapter 5 of this manual in the section titled "Selecting the Measurement Type".

3. Set up triggering

Press the **Channel** hard key followed by the [Trigger] soft key. Use the soft keys within the trigger menu to make the settings detailed below.

Table 16-1. Trigger Set Up

Item	Required setting
Source:	Internal A (can also use external)

Table 16-1. Trigger Set Up

Item	Required setting
Capture time:	The capture time should be sufficient to accommodate the pulse being measured, e.g., 200 ns or 5 μ s
Delay:	A negative delay value represents the time before the trigger allowing the user to display the pre-trigger information.
Type:	Rising
Level:	Use the numeric keypad to enter a value below the power level to be measured or use the auto trigger setting (default)
Arming:	Automatic (default setting)

4. Set up the gating patterns.

Press the **Channel** hard key followed by the [Gating] soft key.

Press the [Set Up] soft key to display the [Gating Set Up] dialog. Use the arrows on the numeric keypad to select the gating settings required and then enable each one with the [Enabled] soft key. If the default settings are not suitable they can be changed by selecting the gate in the dialog and entering a new value from the numeric keypad in the usual manner.

Press [Exit] when complete and then display the gates on screen by pressing the [Display Gates] soft key.

5. Set the display scaling.

Press the **Channel** hard key followed by the [More] soft key.

Press the [Scaling] soft key to display the [Scaling] menu.

Use the [Set Ref] and the [Set Scale] soft keys to set the level and scale as required.

6. Enter the limits as described in the "Common Procedures" section of this manual.

Press the **Channel** hard key followed by the [More] soft key.

Press the [Limit Checking] soft key to display the [Lim Check] group of commands.

Press the [Set Up] soft key to display the [Limit Checking Set Up] dialog.

Enter the limits as required.

7. Set up the markers as described in the "Common Procedures" section of this manual.

Press the **Channel** hard key followed by the [Markers] soft key.

Use the commands in the [Markers] menu to set up and display the markers as required.

For radar measurement, the user may wish to set up the delta and active markers as shown in the figure below to display the power difference across the burst.

8. Use the advanced marker functions as required.

9. Connect the RF port on the sensor to the DUT and monitor the measurement results on the screen.

10. For multi-pulse measurement use the frame arming facility. Refer to Entering a Frame Arming Level and Duration in chapter 5.

Chapter 17 — OFDM Setup and Measurement

17-1 Setting up Continuous OFDM Measurements

Follow the procedure below to set up the ML248xB / ML249xA to perform measurements on continuous OFDM signals. For framed signals use the procedure outlined for the WLAN signals and use frame arming for triggering.

This set up uses a dithered sample rate.

Note The "OFDM Continuous" option in the [Preset] dialog can also be used to automatically configure the unit for OFDM measurement. Press the **Preset** hard key and then use the arrow keys to select option 14.

1. Perform calibration.

Connect the sensor in use to the input on the front panel.

Connect the RF port of the sensor to the "Calibrator" input on the front panel.

Press the **Cal/Zero** hard key followed by the [Zero & Cal] soft key.

Press the [Zero & Cal Sensor] soft key for the input in use. The sensor is now calibrated and a message displays on the screen when calibration is complete. Remove the sensor from the "Calibrator" input when complete.

Press the **Sensor** hard key followed by the [Cal Factor] soft key to display the [Cal Factor] dialog.

Use the soft keys to select [Frequency] at the "Source" item, and then enter the required frequency after selecting the "Frequency" item. Correction data is read from the EEPROM in the sensor and applied automatically to the measurement based on the input frequency.

2. Set up the channel.

Press the **Channel** hard key followed by the [Setup] soft key to display the [Channel Set Up] dialog. The settings required in this dialog are detailed below.

Table 17-1. Channel Set Up

Item	Required setting
Mode:	Pulsed/Modulated
Measurement:	Select the type of measurement to be made on the data. Refer to the explanation in chapter 5 of this manual in the section titled "Selecting the Type of Measurement to be Made".
Meas display:	Readout

3. Set the triggering source.

Press the **Channel** hard key followed by the [Trigger] soft key to display the [Trigger] group of commands.

Press the [Trigger Source] soft key and select [Cont].

4. Set the time over which the measurement is taken. The preset uses 1ms.**5.** Set the sample rate.

Press the **Channel** hard key followed by the [Trigger] soft key. Then press [More] followed by [Set Sample Rate].

Select 2MS/s. This sample rate is derived from digitally dithering the 64 or 62.5 MS/s sample rate with a pseudo random sequence.

Connect the RF port on the sensor to the DUT and monitor the measurement results on the screen.

Chapter 18 — Examples of Dual Display Operation

This chapter provides details of two scenarios in which the user may wish to view both measurement channels simultaneously.

18-1 Changing Display Units

The user may wish to display the measurement from one sensor using different units of measurement on each channel. The example below details how to set up the channels to display in Watts on channel 1, and in dBm on channel 2.

1. Press the **Channel** hard key followed by the [Set Up] soft key to display the [Channel Set Up] dialog.
2. Use the soft keys to set the "Mode" to "CW".
3. Press the down arrow on the keypad to select "Input Config" and check that the channel is configured for the correct input.
4. Press the down arrow on the keypad to select "Units" and use the soft keys to select "W".
5. Press the **Ch1/Ch2** hard key.
6. Use the soft keys to set the "Mode" to "CW".
7. Press the down arrow on the keypad to select "Input Config" and check that the channel is configured for the correct input.
8. Press the down arrow on the keypad to select "Units" and use the soft keys to select "dBm".
9. Press the [Dual Channel] soft key and then press the [Exit] key on the keypad.

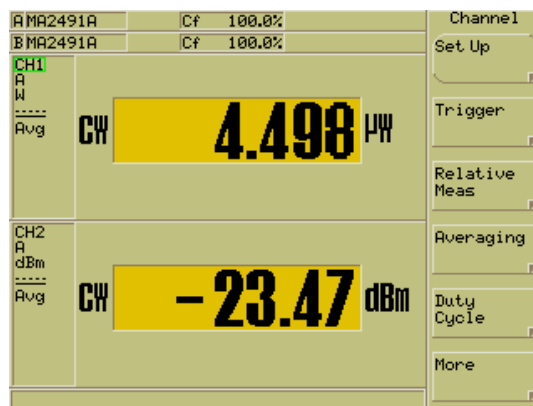

Figure 18-1. Dual Channel Display

18-2 Changing Display Modes

1. Press the **Channel** hard key followed by the [Set Up] soft key to display the [Channel Set Up] dialog.
2. Use the soft keys to set the "Mode" to "Pulsed/Modulated".
3. Press the down arrow on the keypad to select "Meas display" and use the soft keys to select "Profile".
4. Press the down arrow on the keypad to select "Input Config" and check that the channel is configured for the correct input.
5. Press the down arrow on the keypad to select "Units" and use the soft keys to select "dBm".
6. Press the **Ch1/Ch2** hard key.
7. Use the soft keys to set the "Mode" to "Pulsed/Modulated".
8. Press the down arrow on the keypad to select "Meas display" and use the soft keys to select "Readout".
9. Press the down arrow on the keypad to select "Input Config" and check that the channel is configured for the correct input.
10. Press the down arrow on the keypad to select "Units" and use the soft keys to select "dBm".
11. Press the [Dual Channel] soft key and then press the [Exit] key on the keypad.

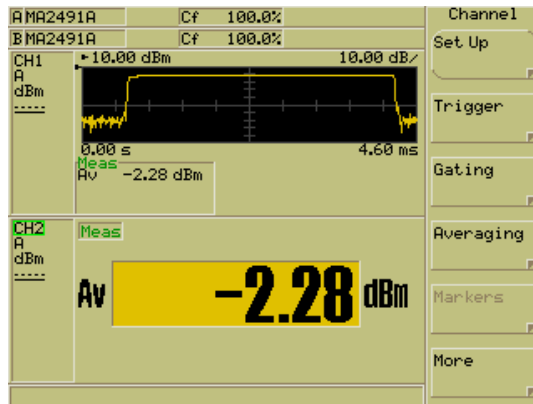

Figure 18-2. Display in Different Modes

Chapter 19 — Dual Sensor Operation

19-1 Displaying Measurements from Two Sensors Simultaneously

As stated earlier in this manual, the ML2488B/ML2496A can display the results for both sensor inputs simultaneously. The user may wish to simply display both measurements as is, but more likely, may want to set one channel to calculate the gain between the two measurements. This scenario is shown in the figure below.

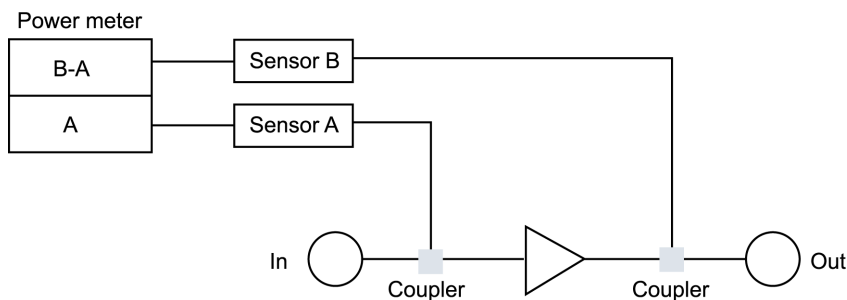

Figure 19-1. Dual Sensor Operation

1. Press the **Channel** hard key followed by the [Set Up] soft key to display the [Channel Set Up] dialog.
2. Use the soft keys to set the "Mode" to "Pulsed/Modulated" or "CW" as required.
3. Press the down arrow on the keypad to select "Meas display" and use the soft keys to select "Readout".
4. Press the down arrow on the keypad to select "Input Config" and then press the [Sngl/Cmb] soft key.
5. For the purposes of our example above, we will select [B-A] to calculate the gain in dBm.
6. Press the down arrow on the keypad to select "Units" and use the soft keys to select "dBm".
7. Press the **Ch1/Ch2** hard key.
8. Use the soft keys to set the "Mode" to "Pulsed/Modulated".
9. Press the down arrow on the keypad to select "Meas display" and use the soft keys to select "Readout".
10. Press the down arrow on the keypad to select "Input Config", and use the soft keys to select "A".
11. Press the down arrow on the keypad to select "Units" and use the soft keys to select "dBm".
12. Press the [Dual Channel] soft key and then press the [Exit] key on the keypad.

Displaying Measurements from Two Sensors Simultaneously **Dual Sensor Operation**

13. In addition to the measurement results, the current setup for each display channel is shown in the pane on the left of the screen.

Chapter 20 — Secure Mode

20-1 Types of Memory

The ML248xB and ML249xA power meters have three different types of memory device in the power meter.

Flash Memory (2 Mbyte)

This contains the firmware for the main processor, the firmware for the DSP, the code for the FPGA, the Instrument type, the options fitted and the serial number. It does not contain any user information or any variables generated during the execution of the code. The user cannot access this memory or write to it directly.

Volatile Static RAM (1Mbyte + internal DSP memory)

This contains the DSP execution code variables. This is initialized on power up and wiped clean when powered down. The user cannot write to this memory directly, and it is completely cleared during power down. This memory is not accessible by the user.

Non-volatile Static RAM (1Mbyte)

This is a battery backed static RAM used to store the current instrument set up, saved instrument set ups, and the main processor code execution variables. All of the user set parameters such as the frequency used for the cal factor, the trigger time, and which sensor is connected are stored in these set ups. The user cannot write to this memory directly, but it can be completely cleared using the secure mode procedure. The user can store and retrieve instrument set ups in this memory.

20-2 Secure Mode

Information such as the cal factor frequency needs to be removed from the power meter if the power meter is moved out of a secure facility. This can be accomplished very easily by using the secure mode to completely wipe the non-volatile static RAM of all information.

The user sets the secure mode on the power meter. When the power meter is next turned on the non-volatile static RAM is completely purged of all information. The power meter then sets the factory defaults for the current settings.

20-3 Clearing the Non-Volatile Static RAM

Press the **System** hard key followed by the [Service] soft key. Press the [Secure] soft key within the [Service] menu to light the green LED. Switch the power off and then on again. The power meter will now power up with the non-volatile memory completely purged. The code execution variables are also purged at power on as well.

The secure state can also be set over the GPIB using the following command NVSECS ON.

20-4 Anritsu Power Sensors EEPROM

Anritsu manufactures several different families of sensors. All families have an EEPROM type of memory device in the power sensor.

All A,B,C sensors (except MA2490/1A and MA2411B series sensors)

These sensors all contain a 64Kbit, 8K x 8 EEPROM.

All D sensors (including MA2490/1A and MA2411B series sensors)

These sensors all contain a 128Kbit, 16K x 8 EEPROM.

20-5 EEPROM Contents

The EEPROM is used to store the following information

- Linearity data
- Temperature Correction Coefficients
- Sensor ID
- Factory cal factor data
- User cal factor table data

Only the user cal factor table data can be erased without the functionality of the sensor being affected. This can be done by pressing **Sensor** > [Edit Tables] > [Edit CF Table] > [Table Init] > [Clear Table].

Appendix A — PowerMax Software

PowerMax (MX249001A) is a software package that allows the user to control the ML248xB/ML249xA power meter (with firmware v2.31 or greater) from a remote PC. Use of the larger PC monitor offers a number of benefits including more immediately comprehensible setting fields, a larger trace display area, and the ability to capture and save trace and image data.

PowerMax can be downloaded from the Anritsu Website at:

<https://www.anritsu.com/en-US/test-measurement/support/downloads/software/dwl003400>

PowerMax is shipped as standard with all ML248xB/ML249xA power meters purchased, or can be downloaded from the Anritsu web site. An Ethernet connection is established between the power meter and the PC and measurement settings and results are then displayed on a Windows based GUI.

The key features of PowerMax are summarized below.

- Full remote control of the power meter allowing continuous real-time monitoring of measurement traces, print outs, and data archiving for later analysis.
- Familiar Windows based GUI maximizes visibility and operability.
- User information and error messages displayed without blocking the view of the trace or readout.
- Simultaneous display of information for up to four gates and markers.
- Measurement settings split into a number of easily navigable tabbed pages.
- All changes made within PowerMax relayed automatically to the instrument.
- Save and recall instrument settings from the PC.

Refer to the PowerMax Ethernet Software (MX249001A) User Guide (13000-00269) for an overview of the PowerMax software, installation requirements, and instructions for use with the ML248xB/ML249xA power meter.

No prior knowledge of PowerMax is assumed, although a familiarity with the purpose and operation of the ML248xB/ML249xA is required.

Appendix B — Command Hierarchies

The commands within the ML248xB / ML249xA are shown in the command hierarchies in this appendix. The hierarchies are split into manageable sections and not only show all the commands within the grouping, but also all the items within any dialogs that may display. The hierarchies are covered in a logical order, working through the hard keys and all commands within from top to bottom as they display on the screen.

The figure below explains how the hierarchical maps on the following pages are structured.

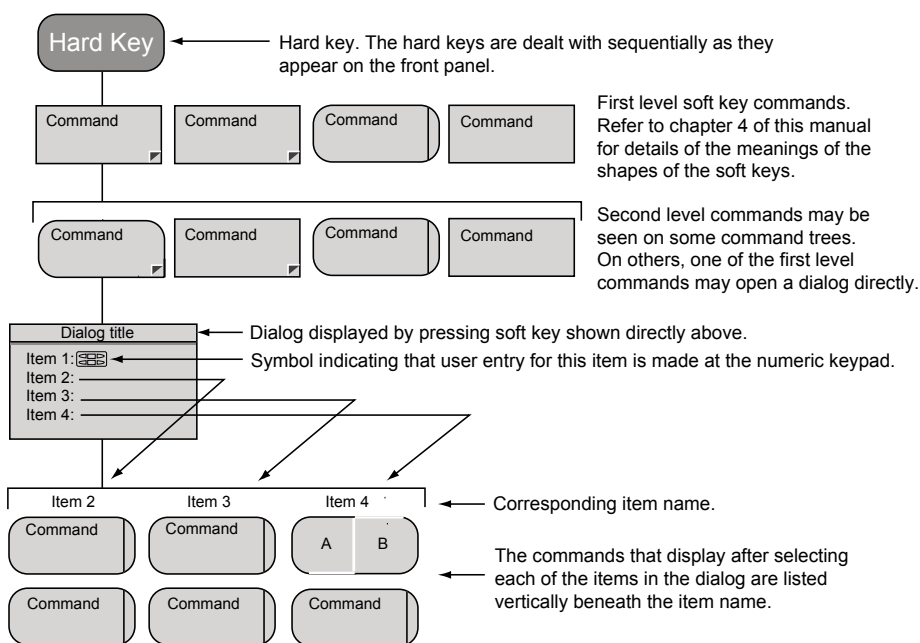
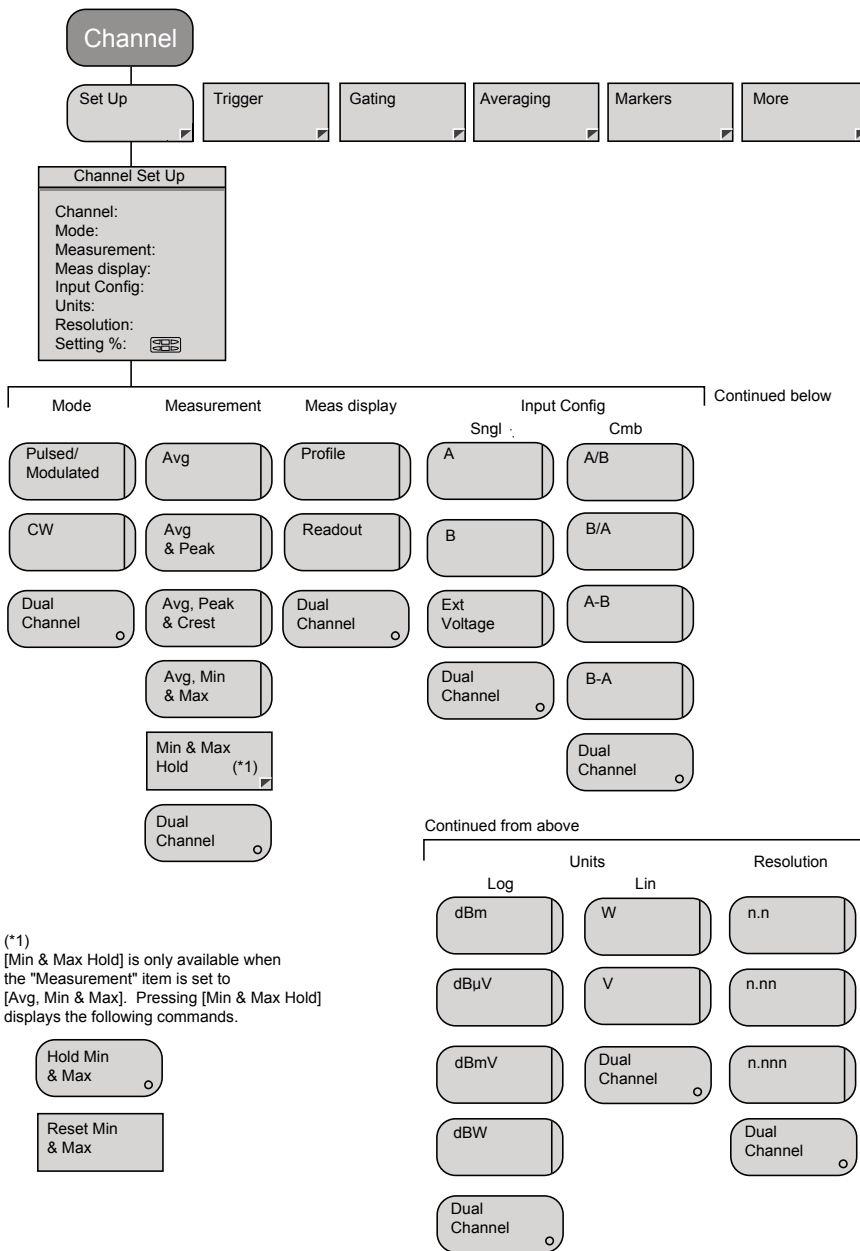
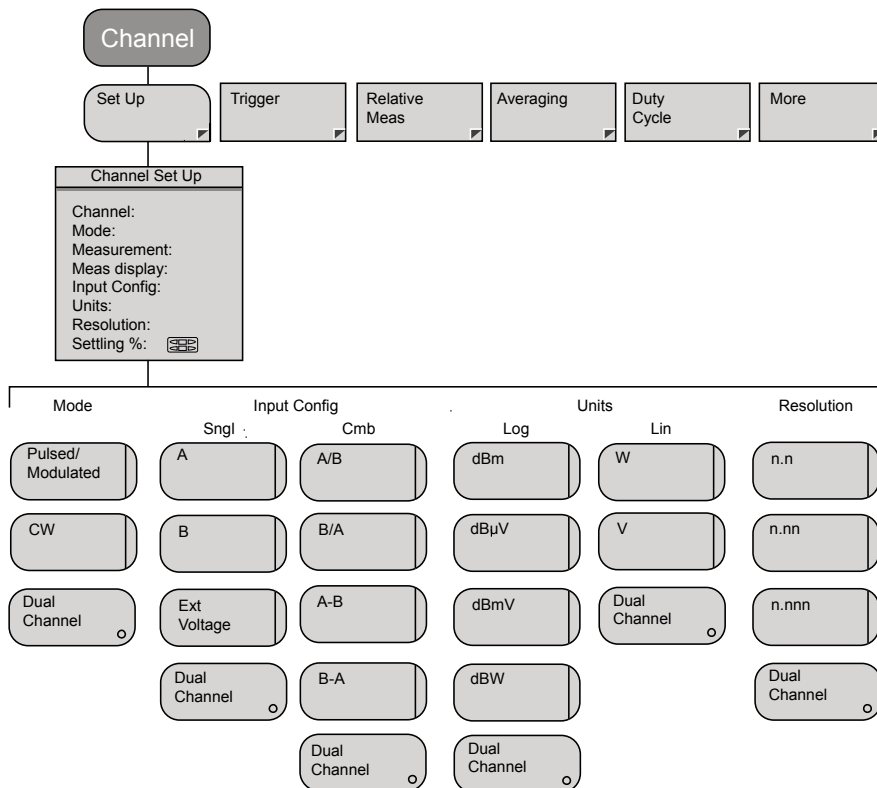

Figure B-1. Command Hierarchy Explanation

B-1 Channel - Set Up (Pulsed/Modulated)



B-2 Channel - Set Up (CW)



B-3 Channel - Trigger - Trigger Source

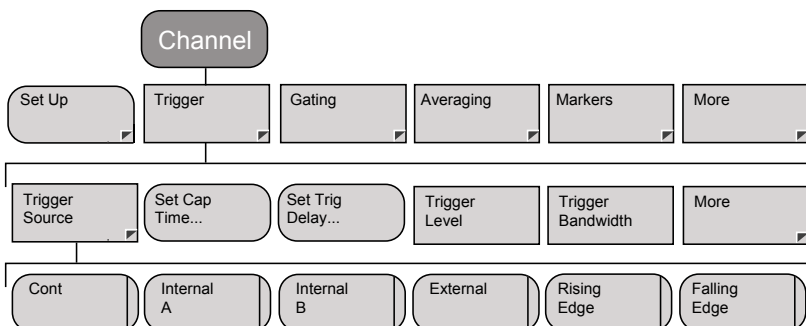

B-4 Channel - Trigger - Set Capture Time

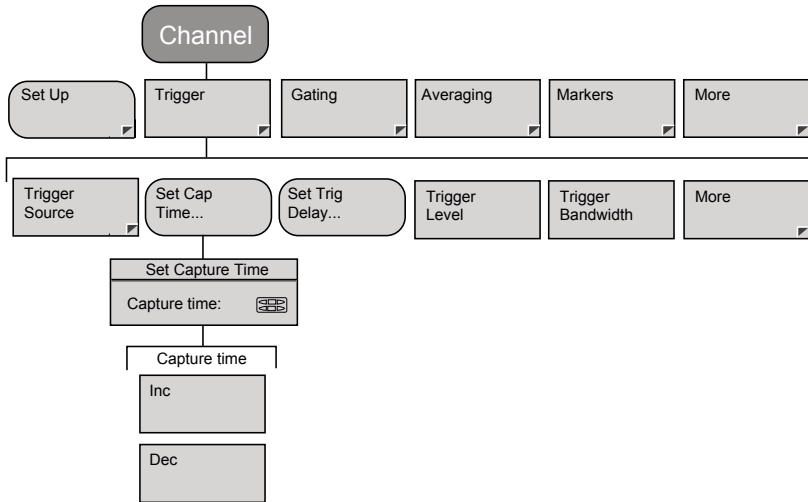

B-5 Channel - Trigger - Set Trigger Delay

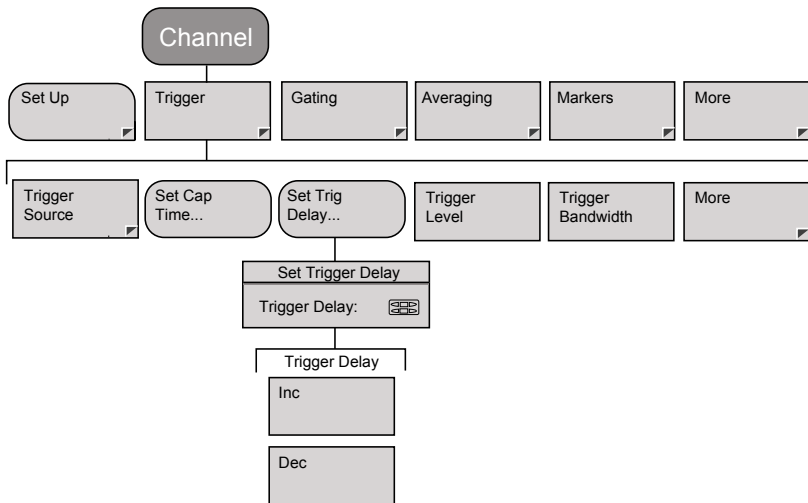

B-6 Channel - Trigger - Trigger Level

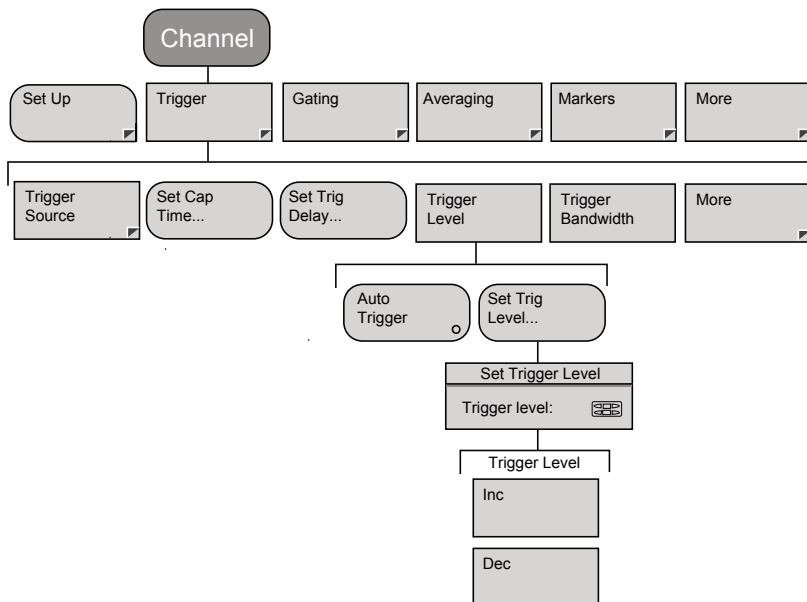

B-7 Channel - Trigger - Trigger Bandwidth (ML249xA only)

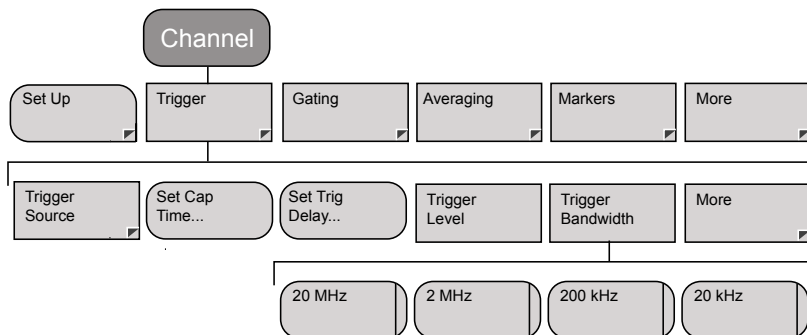

B-8 Channel - Trigger - More - Arming

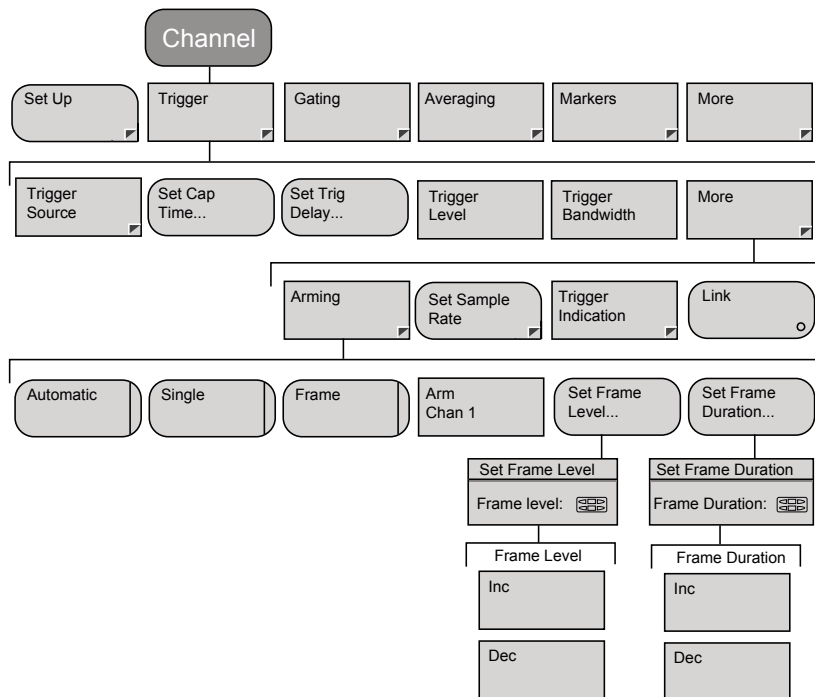

B-9 Channel - Trigger - More - Set Sample Rate

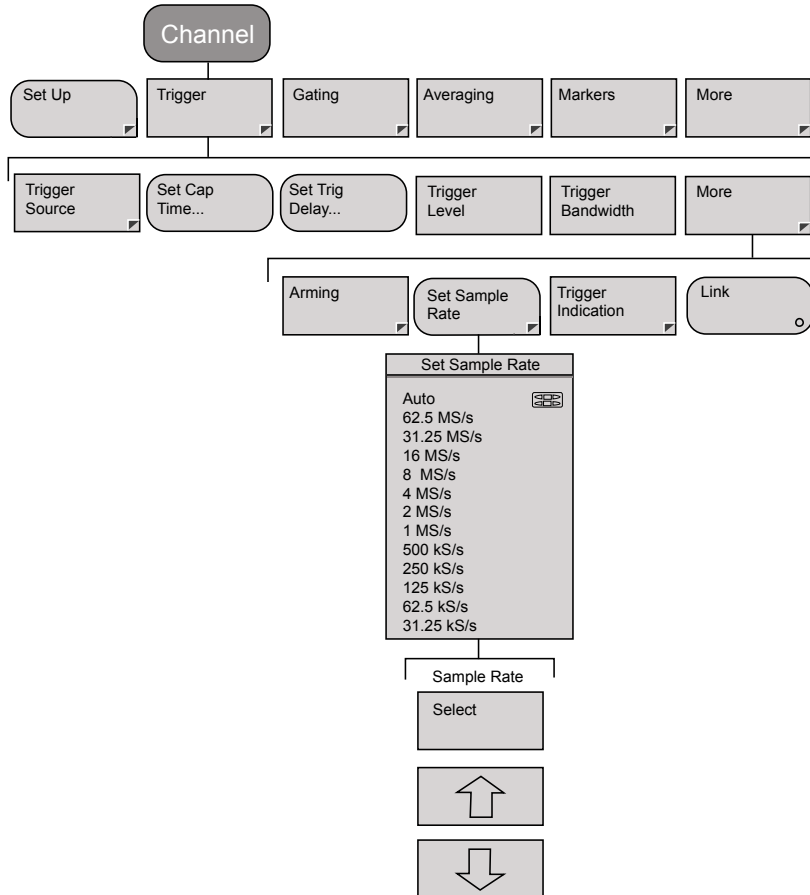

B-10 Channel - Trigger - More - Trigger Indication

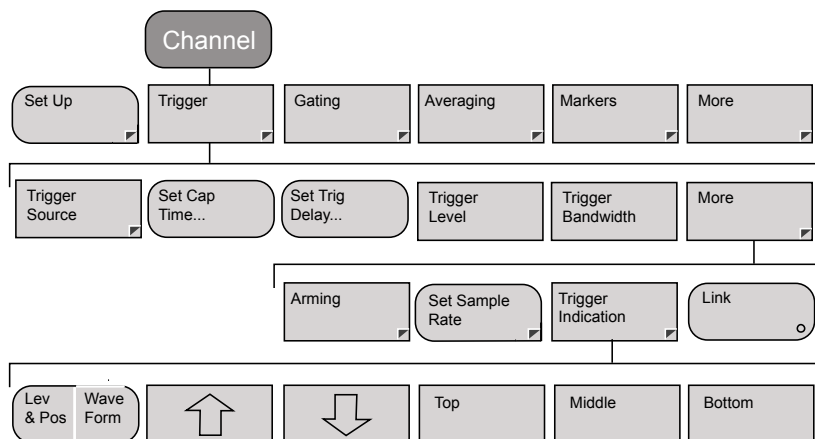

B-11 Channel - Gating - Set Up (Pulsed/Modulated)

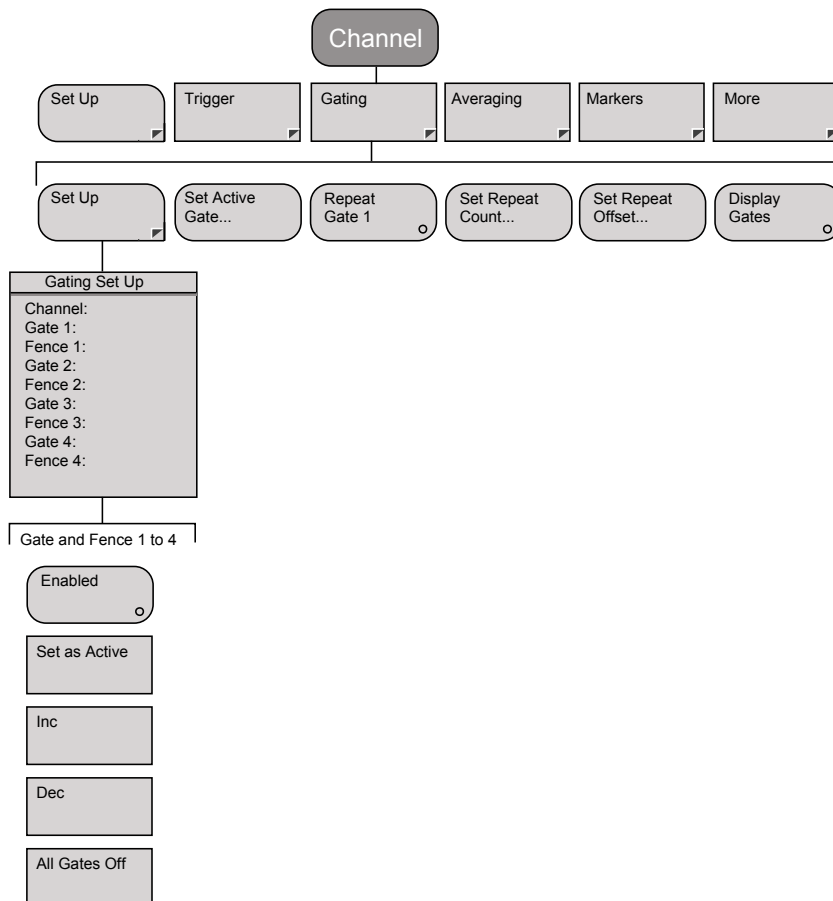

B-12 Channel - Gating (Cont) (Pulsed/Modulated)

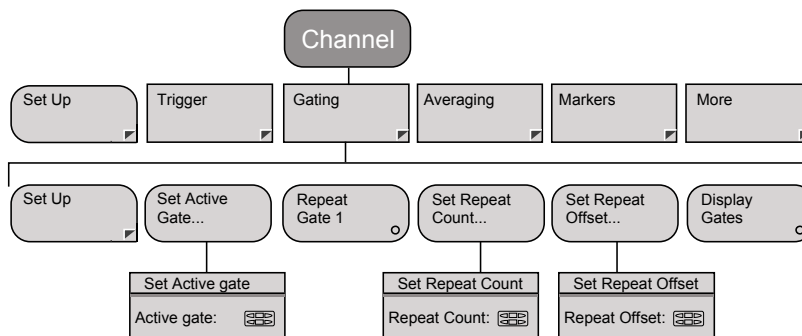

B-13 Channel - Relative Meas (CW)

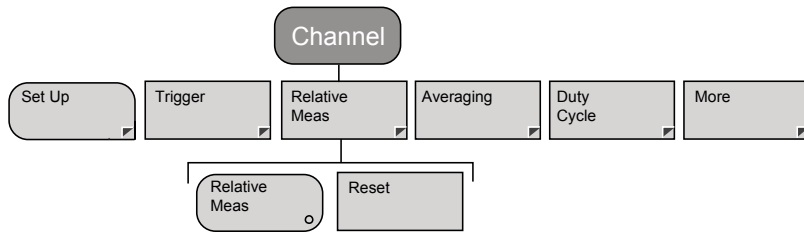

B-14 Channel - Averaging - Set Avg Number (Pulsed/Modulated)

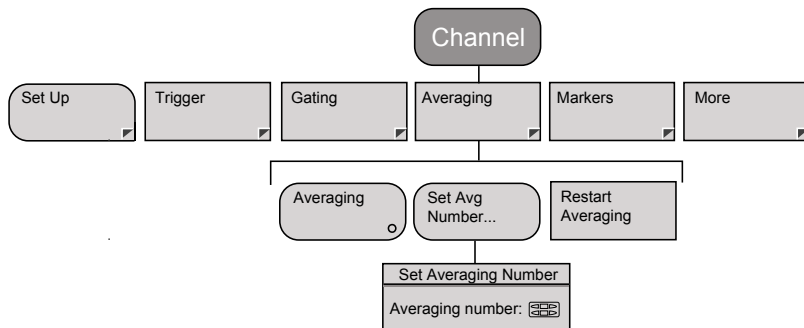

B-15 Channel - Averaging - Set Avg Number (CW)

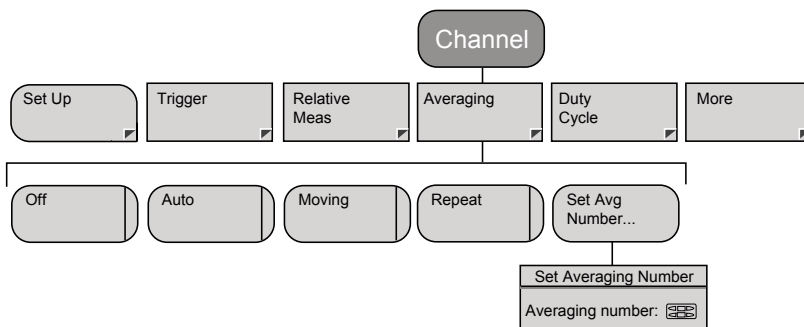

B-16 Channel - Markers - Position Act Mkr (Profile)

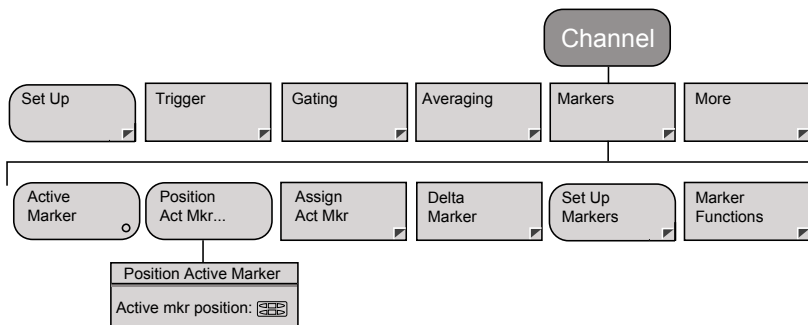

B-17 Channel - Markers - Assign Act Mkr (Profile)

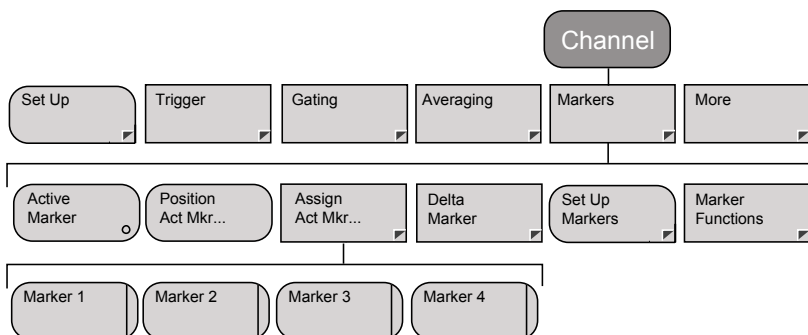

B-18 Channel - Markers - Delta Marker - Position Delta Mkr (Profile)

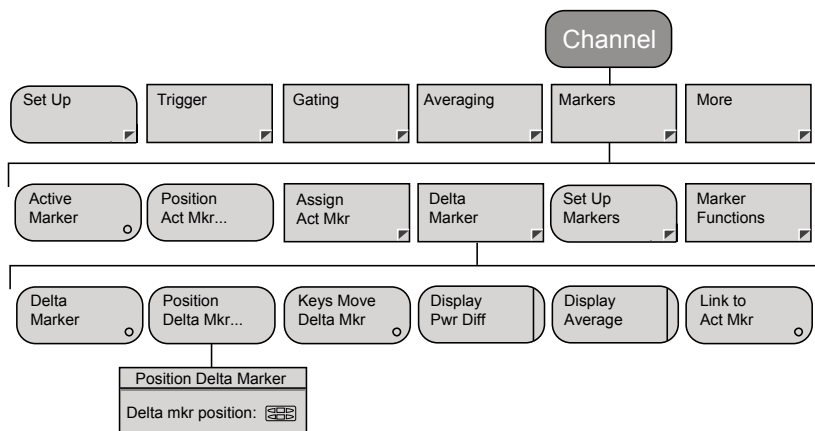

B-19 Channel - Markers - Set Up (Profile)

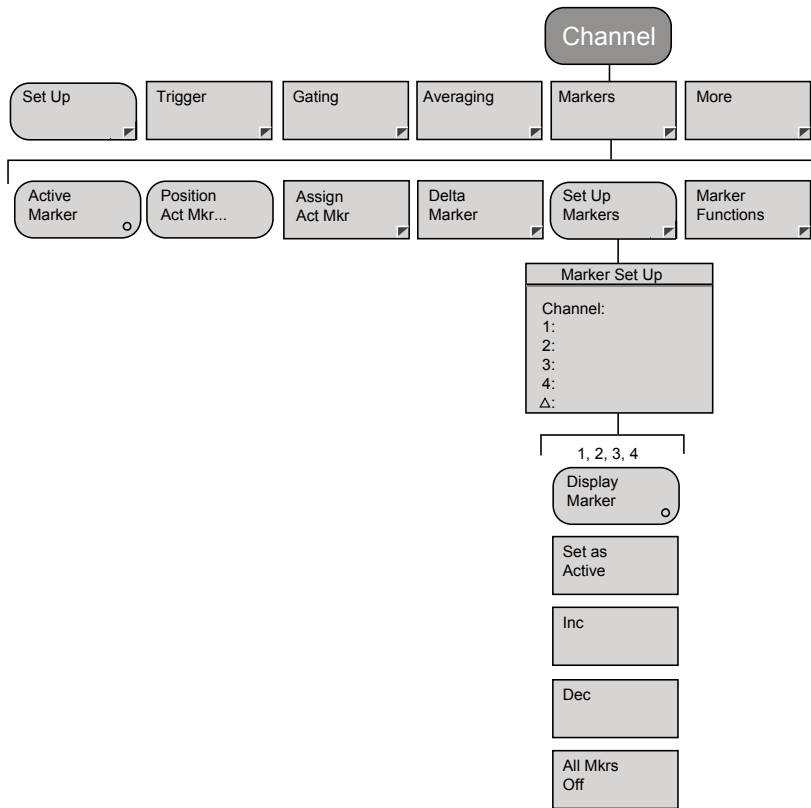

B-20 Channel - Markers - Marker Functions - Advanced Functions (Profile)

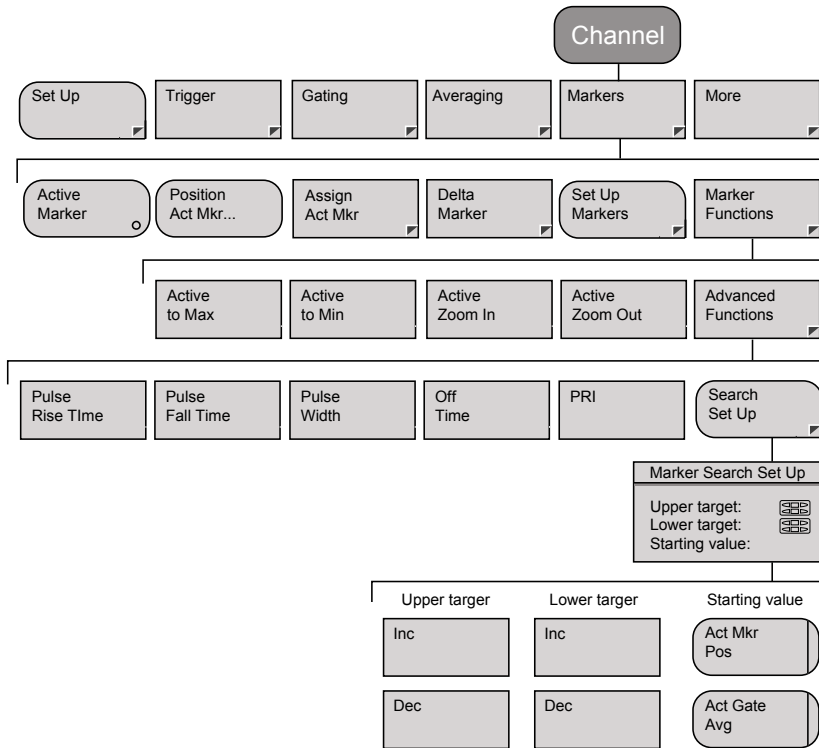

B-21 Channel - Duty Cycle (CW)

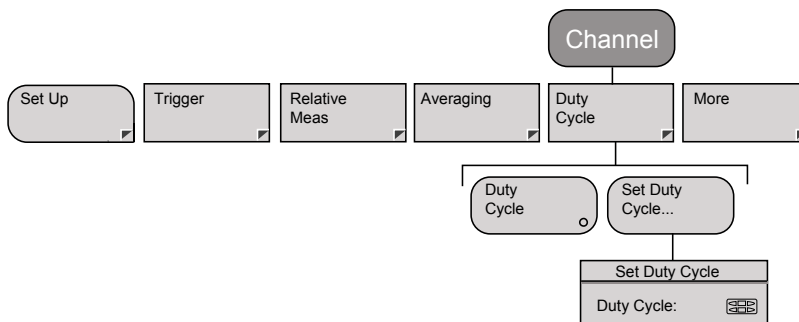

B-22 Channel - More - Limit Checking - Set Up (Pulsed/Modulated)

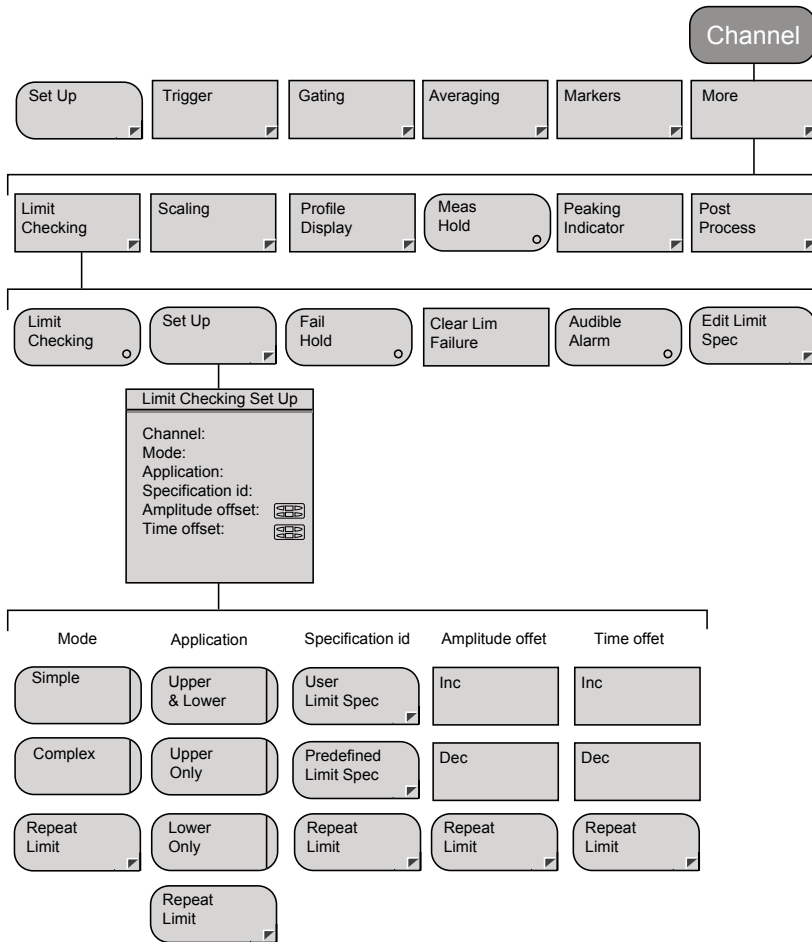

B-23 Channel - More - Limit Checking - Edit Limit Spec - Select Spec

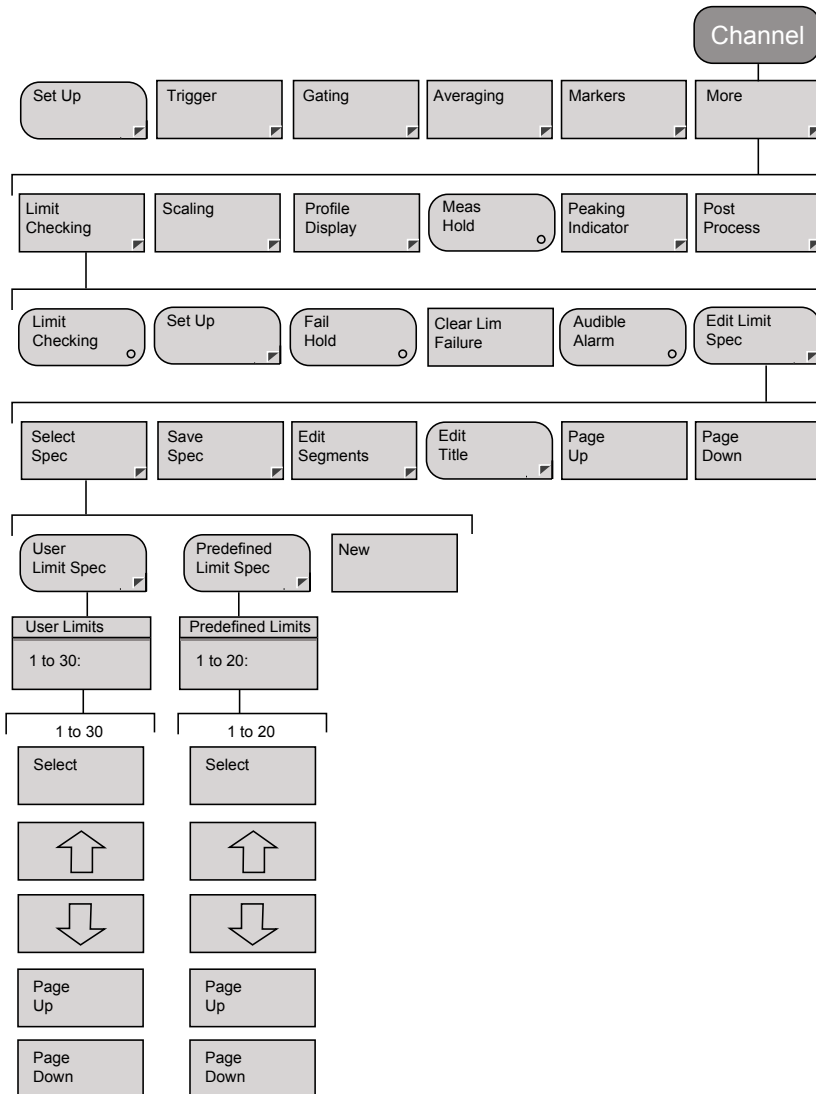

B-24 Channel - More - Limit Checking - Edit Limit Spec - Save Spec

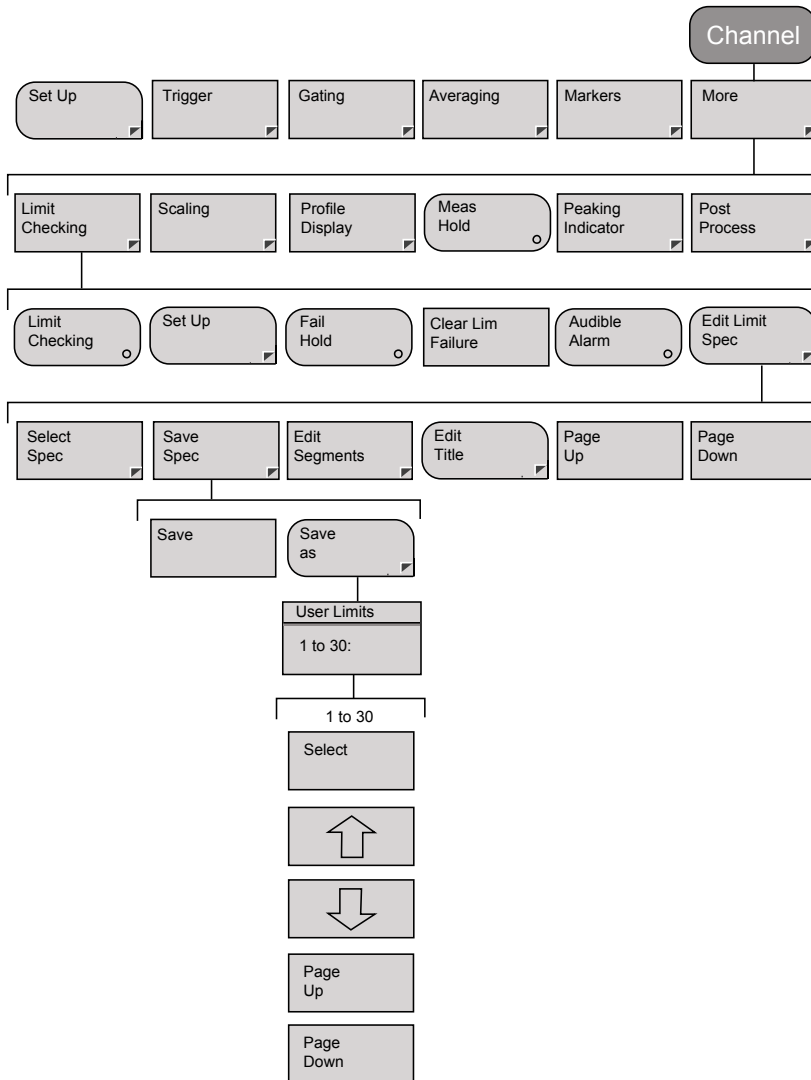

B-25 Channel - More - Limit Checking - Edit Limit Spec - Edit Segments

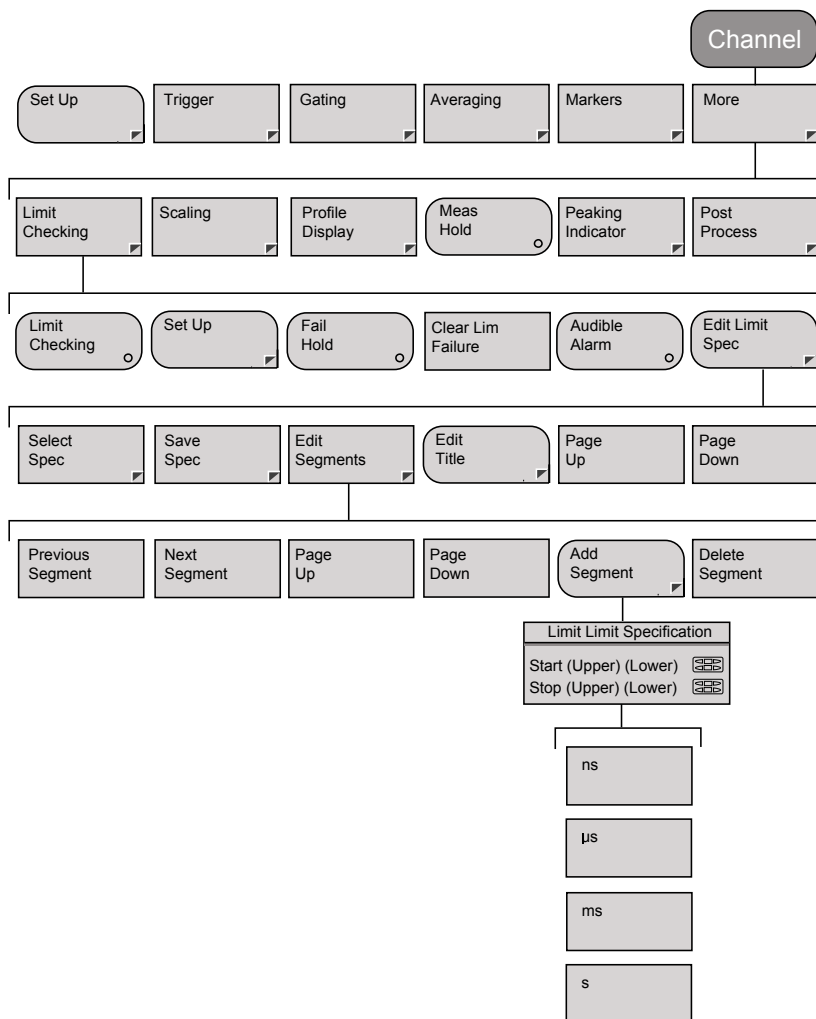

B-26 Channel - More - Limit Checking - Edit Limit Spec - Edit Title

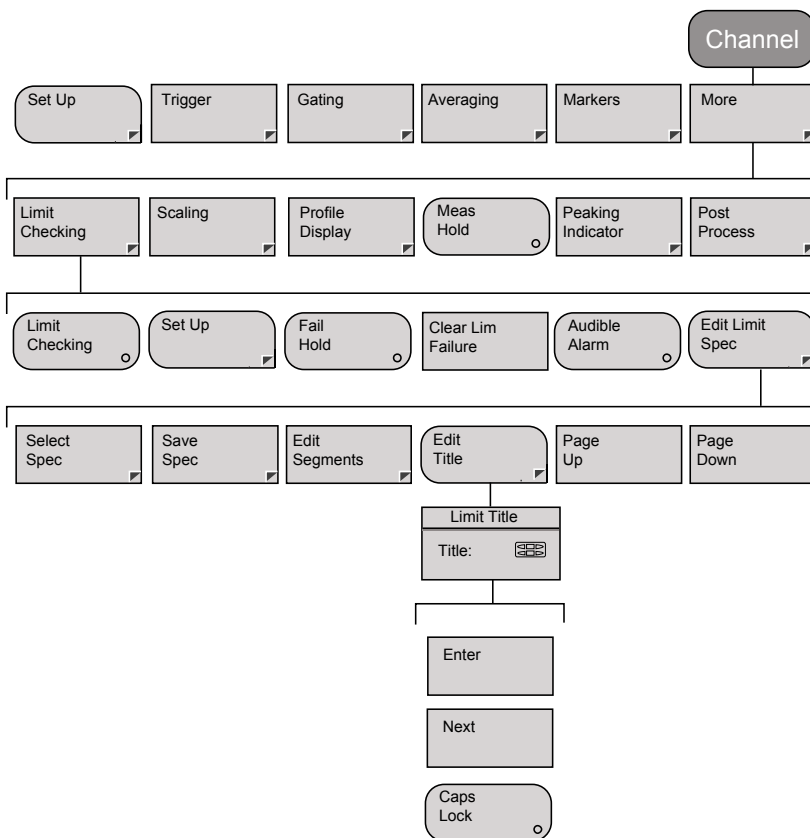

B-27 Channel - More -Scaling (Profile)

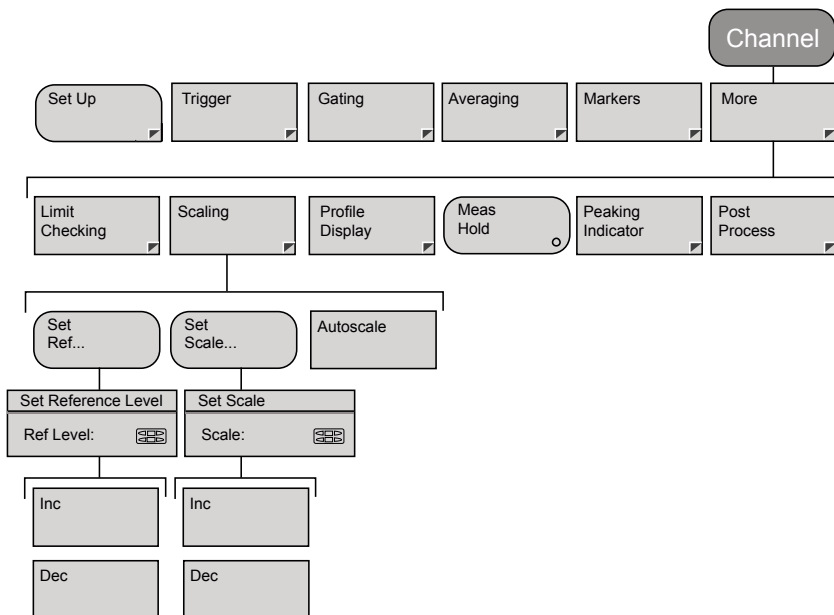

B-28 Channel - More - Profile Display (Profile)

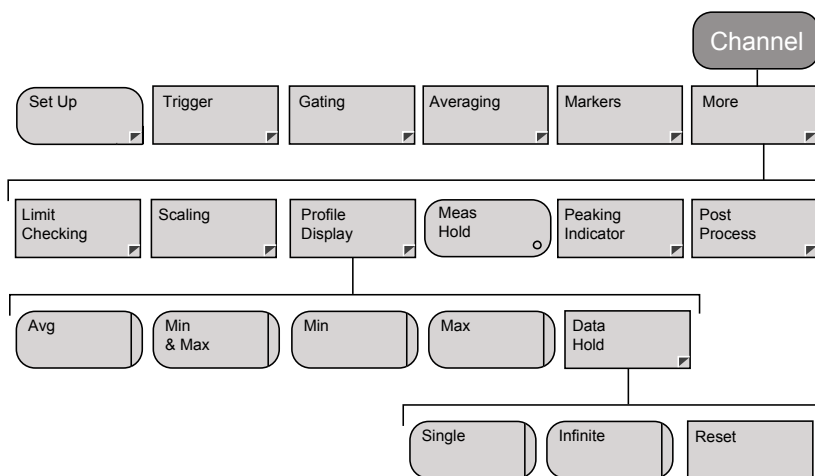

B-29 Channel - More - Peaking Indicator (Pulsed/Modulated)

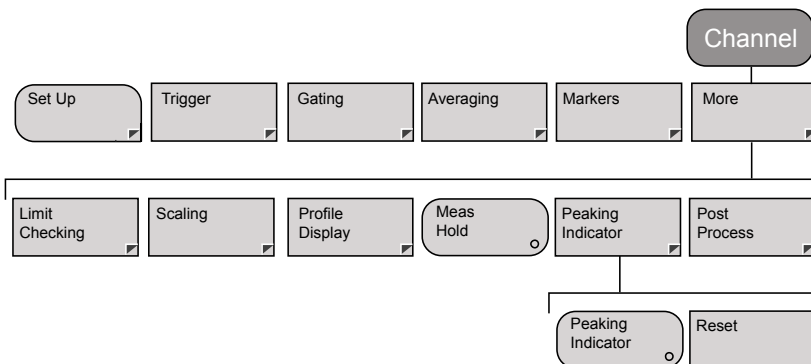

B-30 Channel - More - Peaking Indicator (CW)

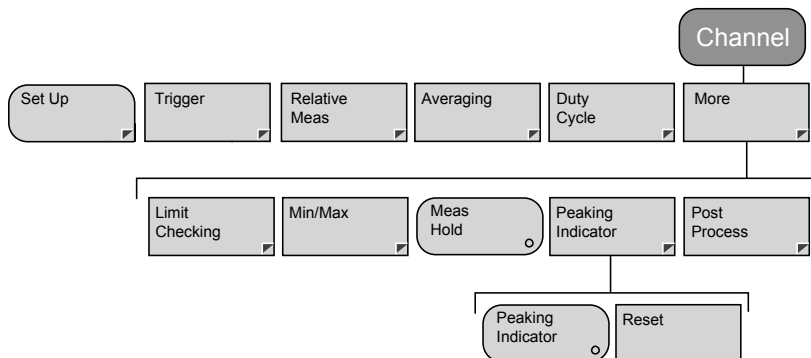

B-31 Channel - More - Post Process - Set Up

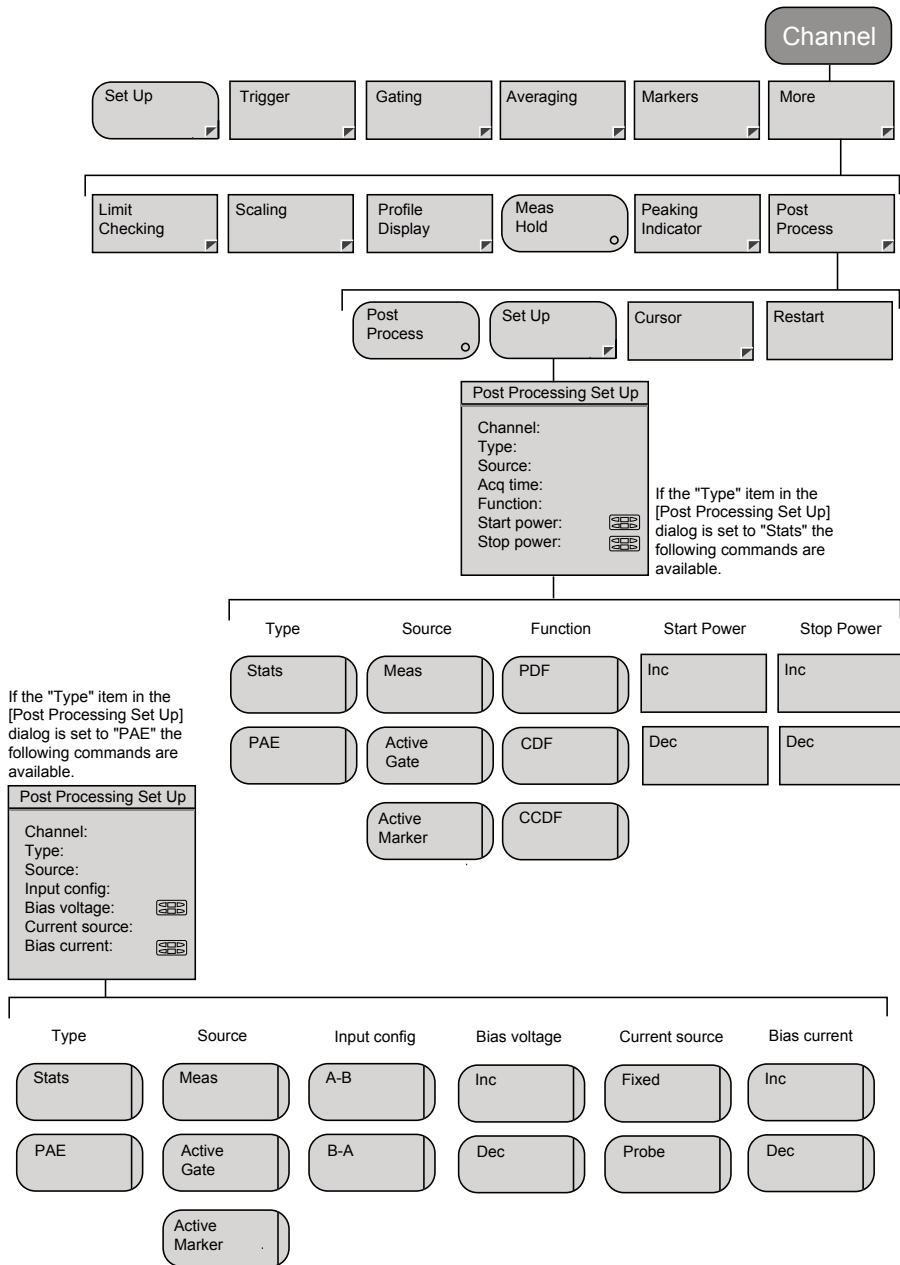

B-32 Channel - More - Post Process - Cursor

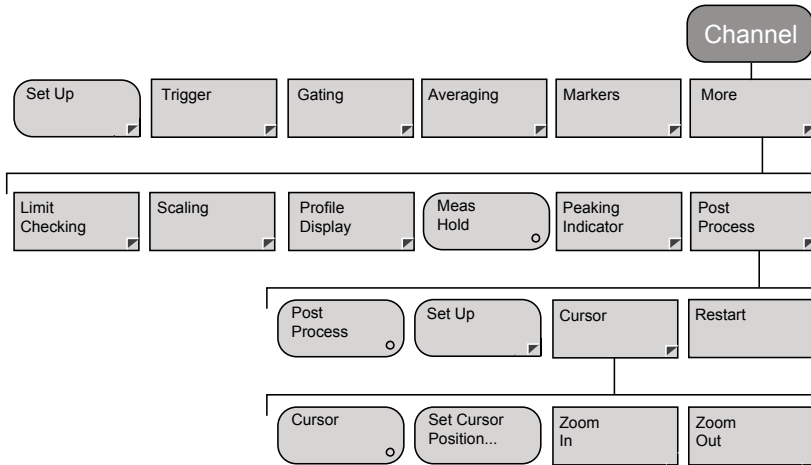

B-33 Sensor - Setup

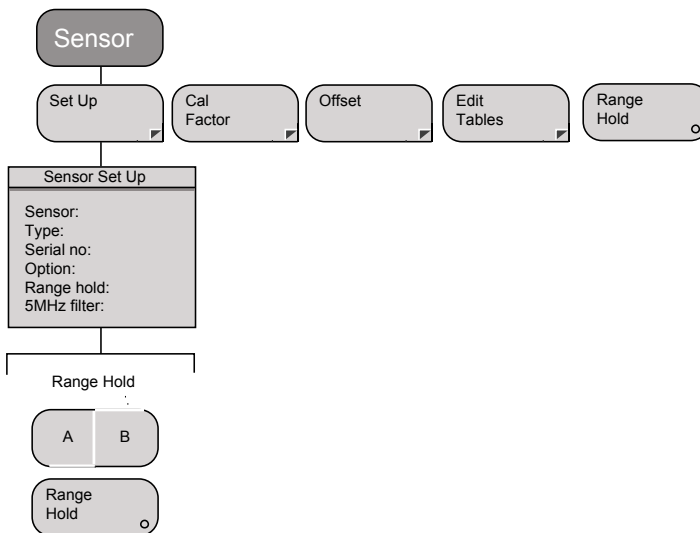

B-34 Sensor - Cal Factor

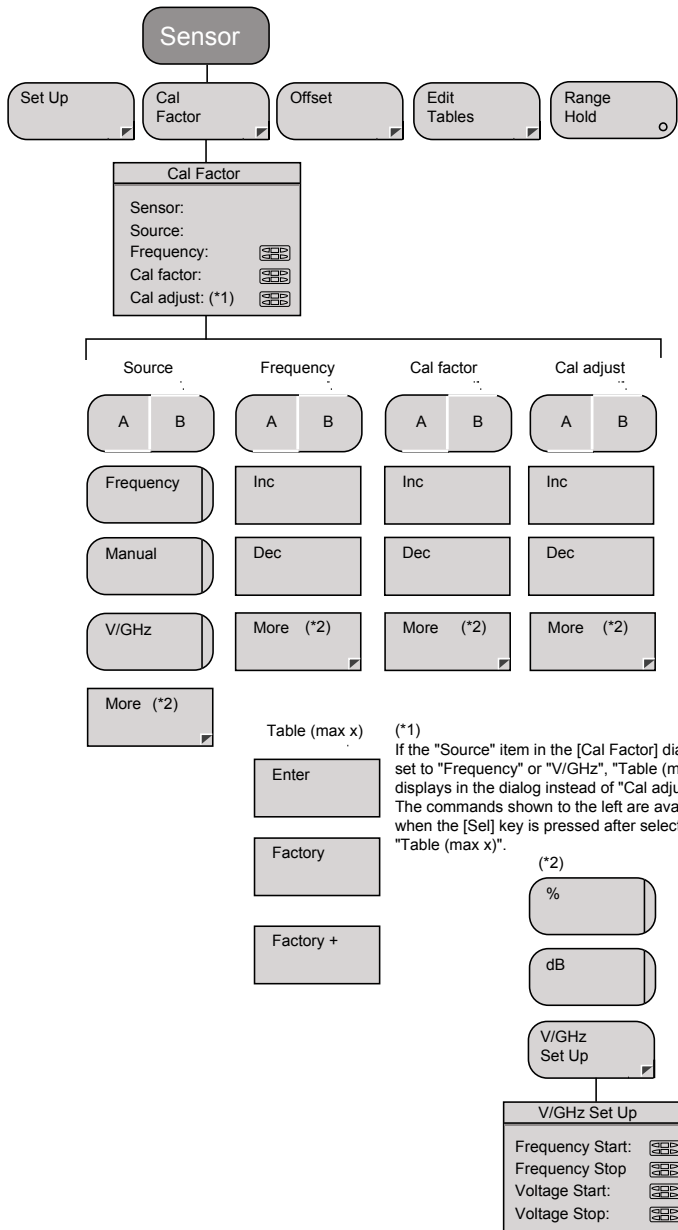

B-35 Sensor - Offset

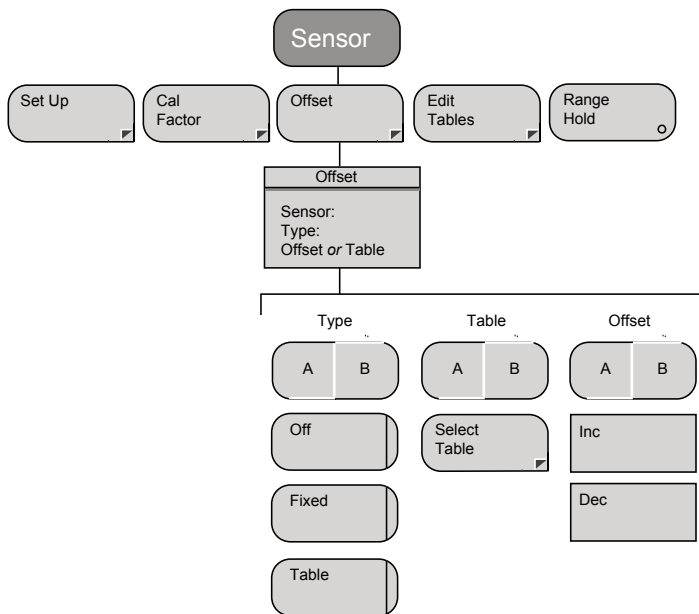

B-36 Sensor - Edit Tables

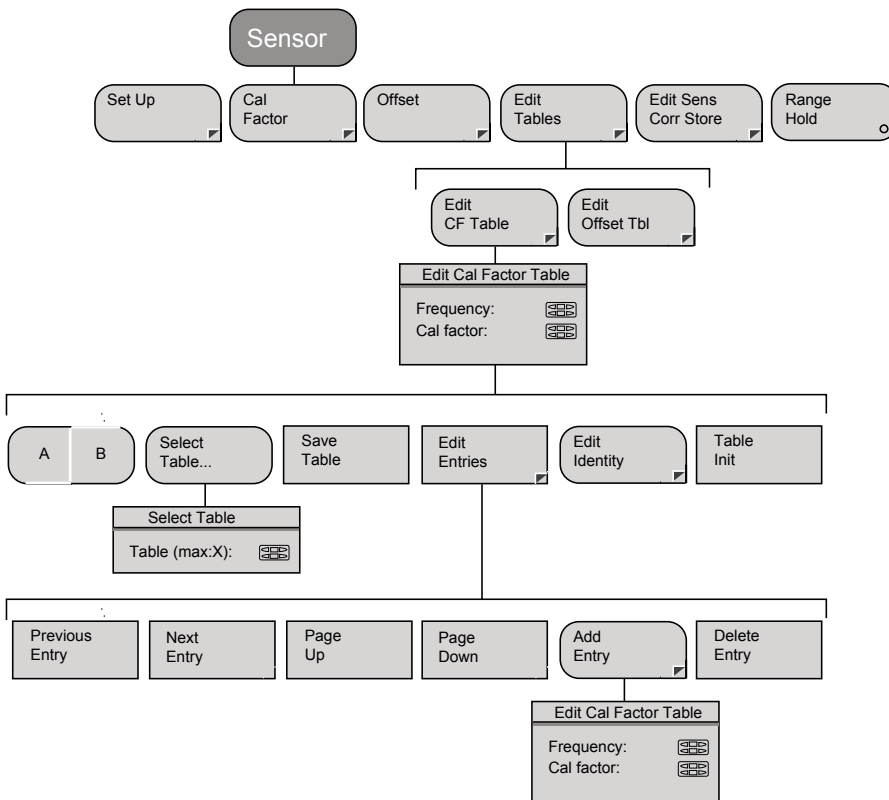

B-37 Sensor - Edit Tables - Edit Identity

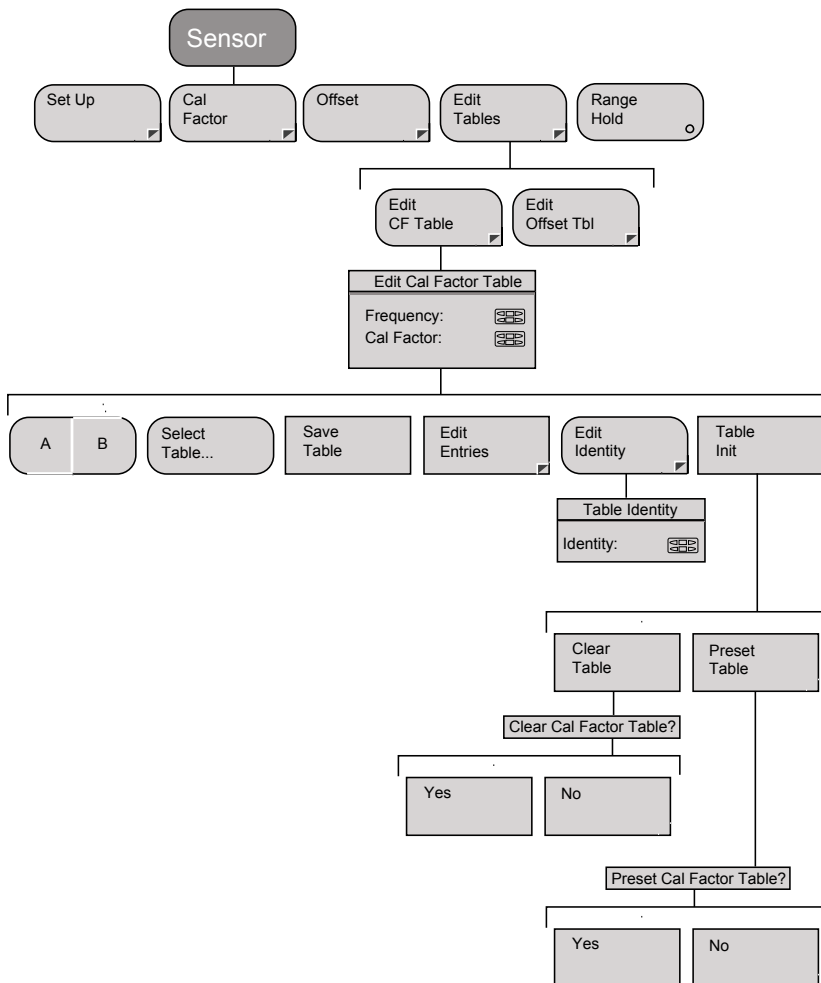

B-38 Sensor - Edit Tables - Edit Offset Table

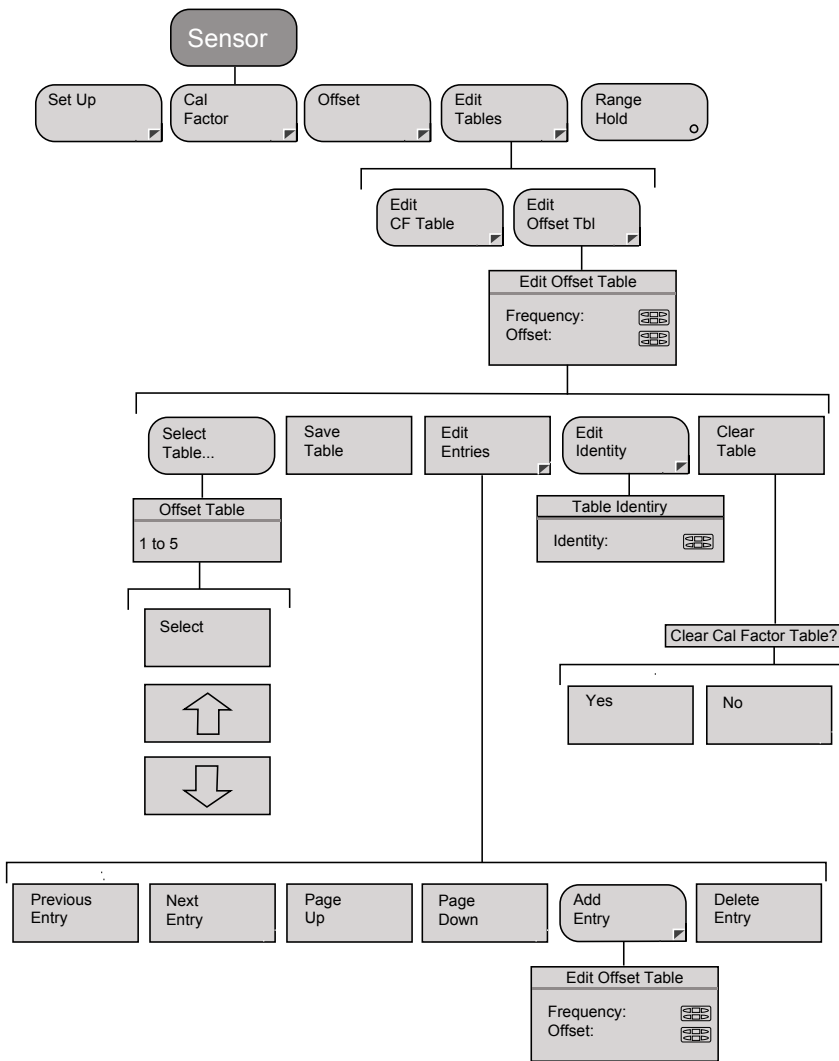

B-39 Cal/Zero

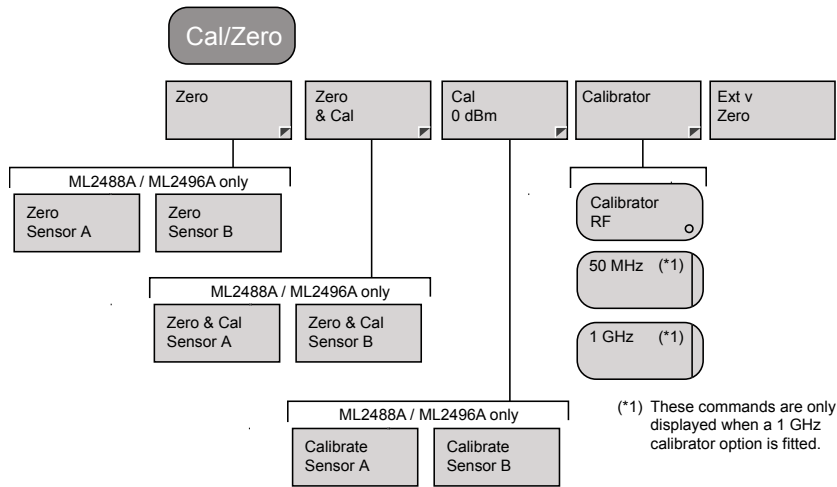

B-40 System - Save / Recall

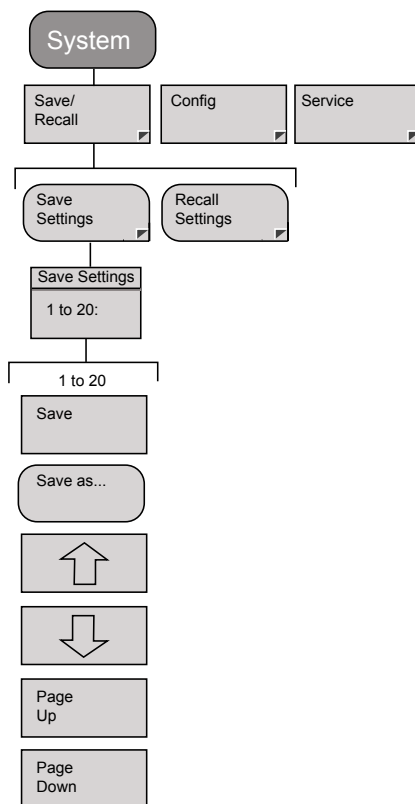

B-41 System - Recall Settings

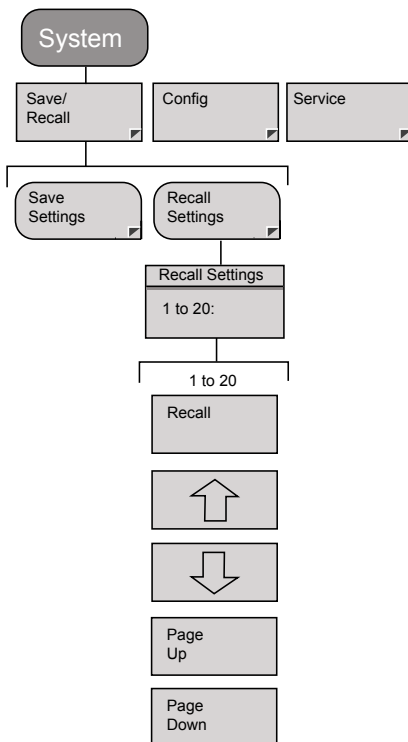

B-42 System - Config - Display - Set Screen Title

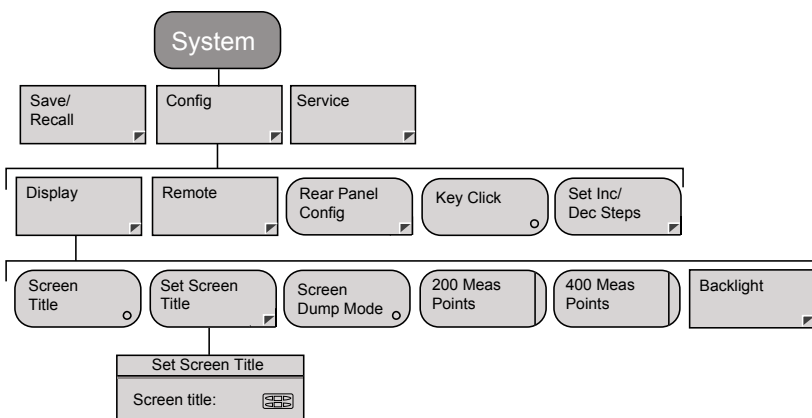

B-43 System - Config - Display - Backlight

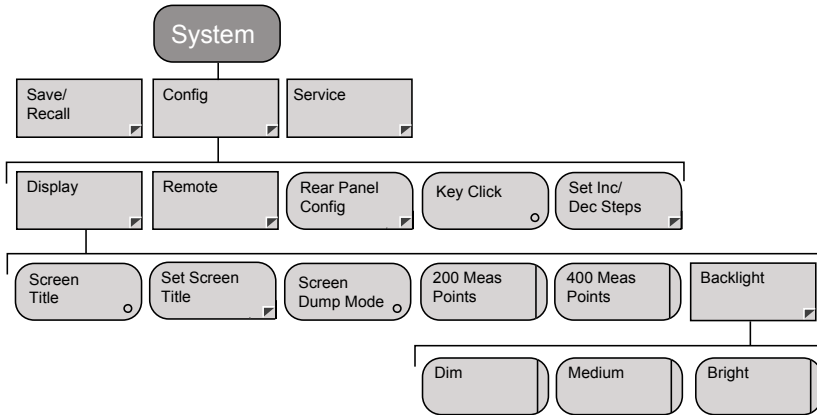

B-44 System - Config - Remote - Set RS232 Baud Rate

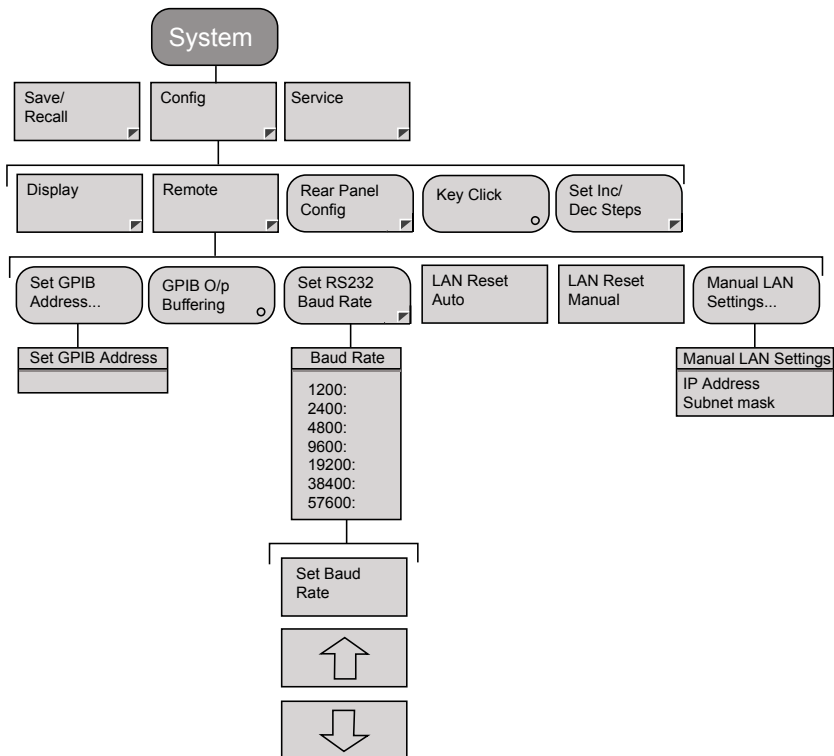

B-45 System - Config - Rear Panel Config

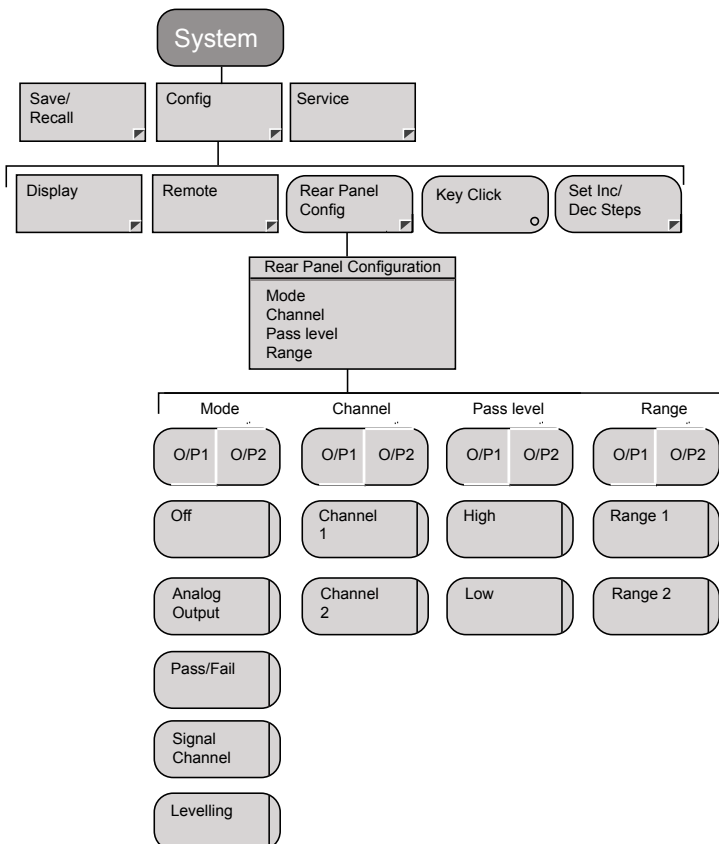

B-46 System - Config - Set Inc/Dec Steps

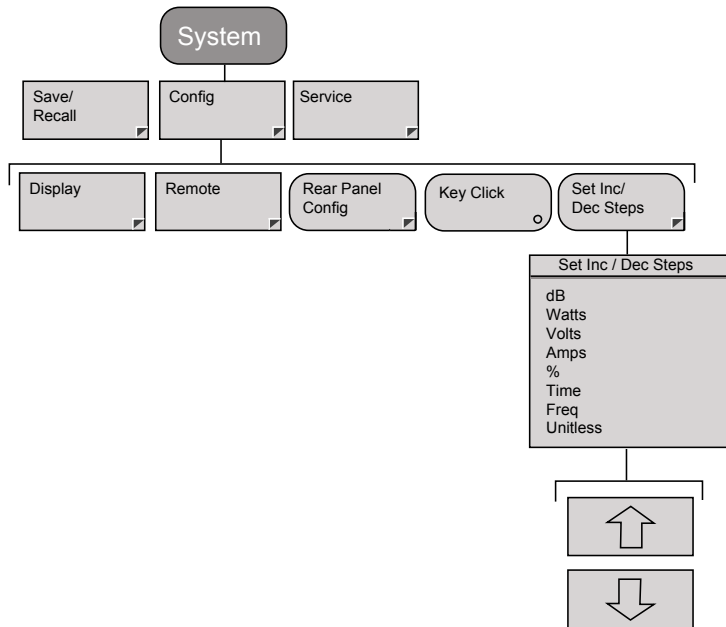

B-47 System - Service - Identity

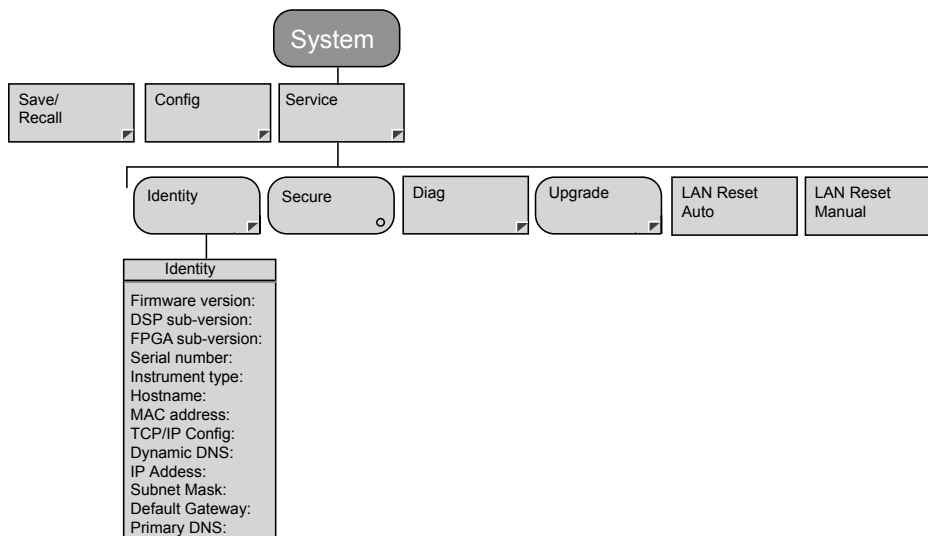

B-48 System - Service - Diag

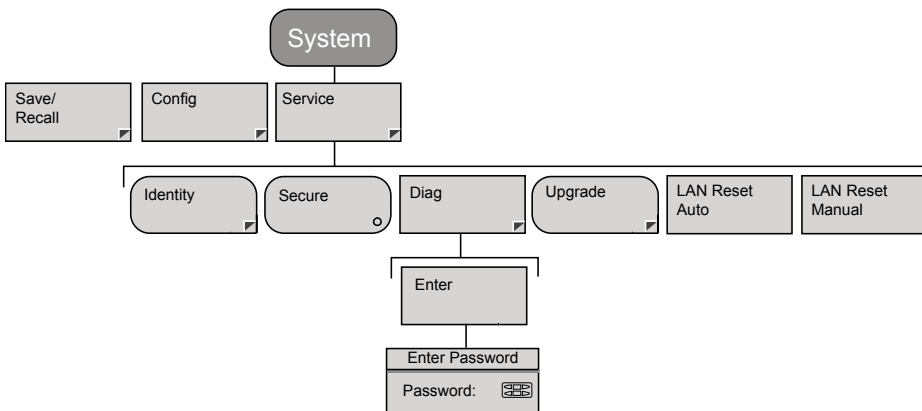

Note The diagnostics group of commands is password protected and available for use by authorized service personnel only.

B-49 System - Service - Upgrade

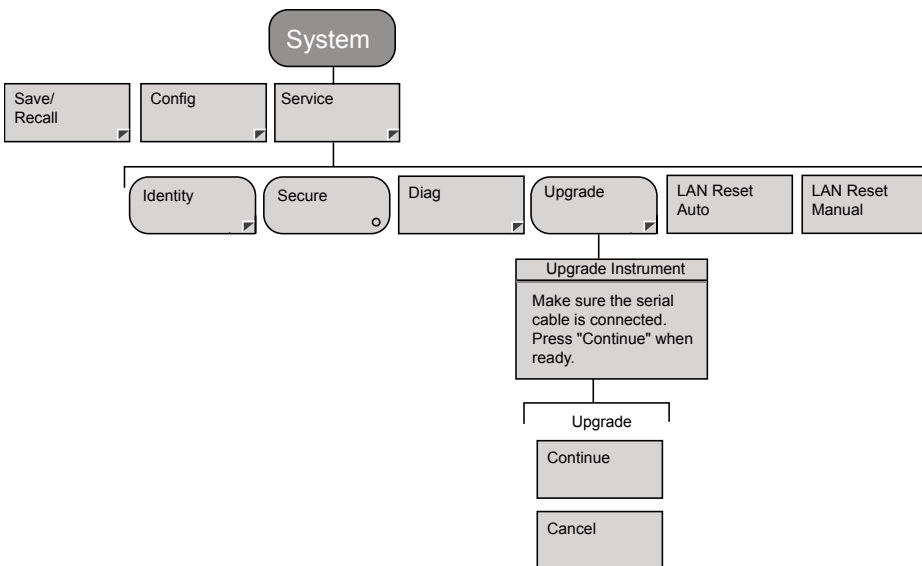

B-50 Preset

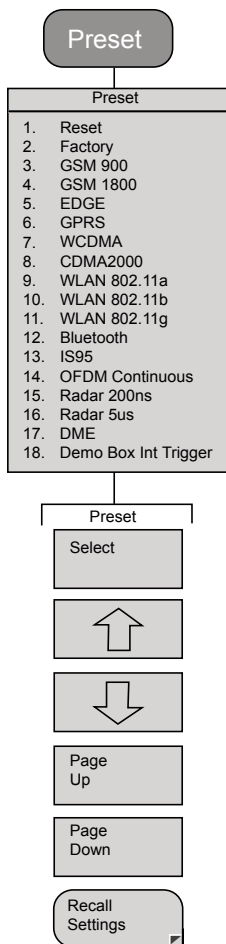

Appendix C — Default Values and Presets

The list below details the ranges and default settings for each item on the ML248xB / ML249xA that can be set by the user. The “Default” values listed indicate the settings for each of the preset configurations and generally apply to all settings. When specific settings have a different Default value, the item is specified and the applicable default value is listed.

Acquisition Time

Range: 1 s to 360000 s

Default: 60 s

Active Channel

Range: Ch1 | Ch2

Default: Ch1

Active Gate

Range: 1 | 2 | 3 | 4

Default: 1

WLAN 802.11a: 2

WLAN 802.11g: 2

Active Marker Assignment

Range: 1 to 4

Default: 1

Amplitude Offset

Range: -999.99 to +999.99exp06

Default: 0

Amplitude Replication Offset

Range: -999.99 to +999.99exp06

Default: 0

Analogue O/P Assignment

Range: Channel 1 | Channel 2

Default: O/P1: Ch1

O/P2: Ch2

Analogue O/P Start Voltage

Range: -5 V to +5 V

Default: -5 V

Analogue O/P Stop Voltage

Range: -5 V to +5 V

Default: +5 V

Audible Alarm on Fail State

Range: Off | On

Default: Off

Audible Alarm State

Range: Off | On

Default: Off

Audible Key Click State

Range: Off | On

Default: Off

Audio Beep on User Entry Error State

Range: Off | On

Default: Off

Auto Sensor ID

Range: Automatic | Off

Default: Automatic

Averaging Mode

Range: Off | Auto | Moving | Repeat

Default: Auto

Averaging Number

Range: 1 to 512

Default: 64

BNC Output 1 ConfigurationRange: Off | Analogue Out | Pass / Fail | Signal Channel A | Levelling A1 |
Levelling A2 | Levelling A1F | Levelling A2F

Default: Off

Default Values and Presets

BNC Output 2 Configuration

Range: Off | Analogue Out | Pass / Fail | Signal Channel B | Levelling B1 | Levelling B2 | Levelling B1F | Levelling B2F

Default: Off

Cal Factor Data Source

Range: Factory | Table | Both

Default: Factory

Cal Factor Frequency

Range: 100 kHz to 400 GHz

Default: 50 MHz

GSM900: 900 MHz

GSM1800: 1800 MHz

EDGE: 900 MHz

GPRS: 900 MHz

WCDMA / CDMA

2000/IS95: 2.2 GHz

WLAN 802.11a: 5 GHz

WLAN 802.11b: 2.4 GHz

WLAN 802.11g: 2.4 GHz

Bluetooth: 2.4 GHz

OFDM Continuous: 50 MHz

Radar 200 ns: 50 MHz

Radar 5 us: 50 MHz

DME: 1 GHz

Demo Box Int

Trigger: 1 GHz

Cal Factor Source

Range: Frequency | Manual Set | V/GHz

Default: Frequency

Cal Factor Table Name

Range: 7 characters max.

Default: 0

Cal Factor Table Number

Range: 1 to 10

Default: 1

Cal Factor Units

Range: dB | %

Default: dB

Capture Time

Range: Pulsed / Mod:

3.125 μ s to 7 s (200 meas point)6.25 μ s to 7 s (400 meas point)CW: 50 μ s to 7 s

Default: 4.6 ms

GSM900: 1.0 ms

GSM1800: 1.0 ms

EDGE: 1.0 ms

GPRS: 3.0 ms

WCDMA / CDMA

2000/IS95: 1.0 ms

WLAN 802.11a: 250.0 μ s

WLAN 802.11b: 4.4 ms

WLAN 802.11g: 250.0 μ sBluetooth: 150.0 μ s

OFDM Continuous: 1.0 ms

Radar 200 ns: 200 ns

Radar 5 us: 5.0 μ sDME: 50 μ s

Demo Box Int

Trigger: 80 μ s**Channel Mode**

Range: CW | Pulsed/Mod

Default: Ch1: Pulsed/Mod

Ch2: CW

DME: Ch1: Pulsed/Mod

Ch2: Pulsed/Mod

Channels Linked

Range: Off | On

Default: Off

Default Values and Presets

Cursor State

Range: Off | On

Default: Off

Data Acq Speed for Levelling O/P

Range: High | Low

Default: High

Delta Marker Link State

Range: Off | On

Default: Off

Delta Marker On/Off

Range: Off | On

Default: Off

Delta Marker Position

Range: TBD

Default: 0

Delta Marker readout Type

Range: Power Difference | Average

Default: Power Difference

Display

Range: Average | Max/Min & Average

Default: Average

Display Start Power

Range: 999.99 dB(m) to +999.99 dB(m)

Default: -70 dB(m)

Display Stop Power

Range: -999.99 dB(m) to +999.99 dB(m)

Default: +20 dB(m)

Display Update State

Range: Off | On

Default: On

Duty Cycle Correction State

Range: Off | On

Default: Off

Duty Cycle Value

Range: 0.1% to 100%

Default: 100%

External Trig Edge

Range: Rising | Falling

Default: Rising

Fail Hold State

Range: Off | On

Default: Off

Fail Hold State

Range: Off | On

Default: Off

Fence Enabled (1 to 4)

Range: Off | On

Default: Off

EDGE: 1: On

2 to 4: Off

Fence Start Time

Range: 0 to 7s

Default: 225 μ sEDGE: 240.6 μ s**Fence Stop Time**

Range: 0 to 7s

Default: 321 μ sEDGE: 336.4 μ s**Fixed Offset**

Range: -200.00 dB to +200.00 dB

Default: 0 dB

Default Values and Presets

Frame Arming Duration

Range: 0 to (63 x Capture Time)

Default: 4.6 ms

GPRS: 600 μ s

WLAN 802.11a: 50 μ s

WLAN 802.11b: 50 μ s

WLAN 802.11g: 50 μ s

Frame Arming Level

Range: -230 dBm to +220 dBm

Default: 0 dBm

GPRS: -5.0 dBm

WLAN 802.11a: -5.0 dBm

WLAN 802.11b: -5.0 dBm

WLAN 802.11g: -5.0 dBm

Function

Range: PDF | CDF | CCDF

Default: PDF

Gate Enabled (1 to 4)

Range: Off | On

Default: Off

GSM 900: 1: On

2 to 4: Off

GSM 1800: 1: On

2 to 4: Off

EDGE: 1: On

2 to 4: Off

GPRS: 1: On

2 to 4: Off

WLAN 802.11a: 1 & 2: On

3 & 4: Off

WLAN 802.11b: 1: On

2 to 4: Off

WLAN 802.11g: 1 & 2: On

3 & 4: Off

Bluetooth: 1: On

Default Values and Presets

2 to 4: Off

DME: 1: On

2 to 4: Off

Demo Box Int

Trigger: 1: On

2 to 4: Off

Gate Start Time

Range: 0 to 7s

Default: 0

GSM 900: 57.7 μ s

GSM 1800: 57.7 μ s

EDGE: 57.7 μ s

GPRS: 57.7 μ s

WLAN 802.11a: 1: 2.0 μ s

2: 30.0 μ s

WLAN 802.11b: 50.0 μ s

WLAN 802.11g: 1: 2.0 μ s

2: 30.0 μ s

Bluetooth: 12.0 μ s

DME: 0

Demo Box Int

Trigger: 5.0 μ s

Gate Stop Time

Range: 0 to 7s

Default: 577 μ s

GSM 900: 519.3 μ s

GSM 1800: 519.3 μ s

EDGE: 519.3 μ s

GPRS: 519.3 μ s

WLAN 802.11a: 1: 18.00 μ s

2: 160.00 μ s

WLAN 802.11b: 4.2 ms

WLAN 802.11g: 1: 18.00 μ s

Default Values and Presets

2: 160.00 μ s
Bluetooth: 108.0 μ s
DME: 5 μ s
Demo Box Int
Trigger: 45 μ s

GPIB Address

Range: 0 to 30
Default: 13

GPIB Fast Mode State

Range: Off | On
Default: Off

GPIB Output Buffering State

Range: Off | On
Default: On

GPIB Screen Dump State

Range: Off | On
Default: Off

Hide Gating Patterns State

Range: Off | On
Default: Off

Input Configuration

Range: A | B | A-B | B-A | A/B | B/A | External Volts
Default: A

Input Offset Mode

Range: Off | Fixed | Table
Default: Off

Input Offset Table Name

Range: 7 characters max
Default: 0

Input Offset Table Number

Range: 1 to 5
Default: 1

Internal Trig Edge

Range: Rising | Falling

Default: Rising

Internal Trigger Level

Range: -230 dBm to +220 dBm

Default: 0 dBm

GSM 900: -5.0 dBm

GSM 1800: -5.0 dBm

EDGE: -5.0 dBm

GPRS: -5.0 dBm

WLAN 802.11a: -5.0 dBm

WLAN 802.11b: -5.0 dBm

WLAN 802.11g: -5.0 dBm

Bluetooth: -5.0 dBm

Radar 200 ns: Auto

Radar 5us: Auto

DME: -10 dBm

Demo Box Int

Trigger: Auto

LAN Reset Manual (static IP address)

Default: 192.168.0.2

LCD Backlight State

Range: Dim | Medium | Bright

Default: Bright

Levelling Range:

Range: 1 | 2

Default: 1

Limit Checking State

Range: Off | On

Default: Off

Limit Checking Type

Range: Simple | Complex

Default: Simple

Default Values and Presets

Lower Limit Value

Range: -999.99 to
+999.99exp06
Default: -999.99

Manually Set Cal Factor (for sensor cal)

Range: 0.07% to 150% or +31.55dB to -1.76 dB
Default: 100% (0 dB)

Marker Position

Range:
Depends on display
time range:
Default: 0

Marker State

Range: Off | On
Default: Off

Marker Table State

Range: Off | On
Default: Off

Marker(1 to 4) On/Off

Range: Off | On
Default: Off
Demo Box Int
Trigger: 1: On

Max Meas Readout Resolution

Range: 1 to 3 decimal places
Default: 2

Max/Min Tracking State

Range: Off | On
Default: Off

Measurement Points Display

Range: 200 | 400
Default: 200
DME: 400

Measurement

Range: Av Power | Av & Pk Power | Av. & Pk Power & Crest Factor | Av Pwr & Max Pwr (and time) & Min Pwr (and time) | Av. Pwr & Held Max Pwr (and time) Held Min Pwr (and time)

Default: Av. Power

GSM 900: Av & Pk Power

GSM 1800: Av & Pk Power

WCDMA / CDMA

200 / IS95: Av. & Pk Power & Crest Factor

WLAN 802.11a: Av. & Pk Power & Crest Factor

WLAN 802.11b: Av. & Pk Power & Crest Factor

WLAN 802.11g: Av. & Pk Power & Crest Factor

Bluetooth: Av & Pk Power

OFDM Continuous: Av. & Pk Power & Crest Factor

DME: Av. & Pk Pwr & Crest Factor

No. of Displayed Channels

Range: 1 - 2

Default: 1

DME: 2

Pass / Fail Assignment

Range: Channel 1 | Channel 2

Default: O/P1: Ch1

O/P2: Ch 2

Pass / Fail Level Assignment

Range: High | Low

Default: O/P1: High

O/P2: High

Pattern 1 Repeat Count

Range: 2 to 8

Default: 2

Pattern 1 Repeat Enabled

Range: Off | On

Default: Off

Default Values and Presets

Pattern 1 Repeat Offset

Range: 0 to 7 s

Default: 577 μ s

Peak Indicator State

Range: Off | On

Default: Off

Post-processing Function

Range: Statistics | PAE

Default: Statistics

Post-processing Function State

Range: Off | On

Default: Off

Power Reference Frequency

Range: 50 MHz | 1 GHz

Default: 50 MHz

Power Reference State

Range: Off | On

Default: Off

Profile Data Representation Type

Range: Min | Max | Min&Max | Normal

Default: Normal

Profile Display Hold State

Range: Off | On

Default: Off

Profile Min/Max Tracking Mode

Range: Single | Infinite

Default: Single

Profile Reference Level (dBm)

Range: -998.99 dBm to 999.99 dBm

Default: 10.0 dBm

GSM 900: 20.0 dBm

GSM 1800: 20.0 dBm

GPSR: 20.0 dBm

WLAN 802.11a: 20.0 dBm

WLAN 802.11b: 20.0 dBm

WLAN 802.11g: 20.0 dBm

Bluetooth: 20.0 dBm

Radar 200 ns: 20.0 dBm

Radar 5us: 20.0 dBm

DME: 20.0 dBm

Demo Box Int

Trigger: 16.0 dBm

Profile Scale (dB)

Range: 0.10 dB to 50 dB

Default: 10.0 dBm

GSM 900: 5.0 dB

GSM 1800: 5.0 dB

GPRS: 5.0 dB

WLAN 802.11a: 5.0 dB

WLAN 802.11b: 5.0 dB

WLAN 802.11g: 5.0 dB

Bluetooth: 5.0 dB

Radar 200 us: 5.0 dB

Radar 5 us: 5.0 dB

DME: 2.0 dB

Demo Box Int

Trigger: 2.0 dB

Range:

Range: CW:

1 | 2 | 3 | 4 | 5 | (6) | Auto

Pulsed/Mod:

7 | 8 | 9 | Auto

Default: Auto

Default Values and Presets

Readout Peak Indicator State

Range: Off | On

Default: On

Relative Measurement State

Range: Off | On

Default: Off

Relative Measurement Value

Range: -999.99 dB to +999.99 dB

Default: 0 dB

Repeat Count

Range: 2 to 8

Default: 2

GPRS: 4

Repeat State

Range: Off | On

Default: Off

GPRS: On

RS232 Baud Rate

Range: 1200 | 2400 | 4800 | 9600 | 19200 | 38400 | 57600

Default: 9600

Default Values and Presets

Sampling rate

Range: 31.5 kS/s to 62.5 MS/s

GSM 900: 1 MS/s

GSM 1800: 1 MS/s

GPRS: 1 MS/s

WCDMA / CDMA

2000 / IS95: 32 MS/s

WLAN 801.11a: 64 MS/s

WLAN 801.11b: 4 MS/s

WLAN 801.11g: 64 MS/s

Bluetooth: 4 MS/s

OFDM Continuous: 2 MS/s

Radar 200ns: 62.5 MS/s

Radar 5 us: 62.5 MS/s

DME: 62.5 MS/s

Demo Box Int

Trigger: 62.5 MS/s

Screen Title State

Range: Off | On

Default: Off

Secure State

Range: Off | On

Default: Off

Select Display Type

Range: Profile | Readout

Default: Profile

WCDMA / CDMA

2000 / IS95: Readout

OFDM Continuous: Readout

DME: CH1: Profile

CH2:Readout

Settle Percentage

Range: 0 to 10%

Default: 0.01%

Default Values and Presets

Sweep Averaging State

Range: Off | On

Default: Off

Sweep Averaging Target Number

Range: 1 to 512

Default: 16

Time Offset

Range: -7 to +7 s

Default: 0 s

Time Replication Offset

Range: 0 to 7 s

Default: 0 s

GPRS

577 μ s

Trig Hold-off State

Range: Off | On

Default: Off

Trig Hold-off Time

Range: 0 to 7 s

Default: 4.6 ms

Trigger Arming Mode

Range: Automatic | Single | Frame

Default: Automatic

GPRS: Frame

WLAN 802.11a: Frame

WLAN 802.11b: Frame

WLAN 802.11g: Frame

Trigger Delay

Range: Pulsed /Mod:

[-1x (0.95 x Capture time)] to 999 ms

CW:

Default Values and Presets

0 to 999 ms

Default: 0

GSM 900: -200.0 μ s

GSM 1800: -200.0 μ s

GPRS: -100.0 μ s

WLAN 802.11a: -50.0 μ s

WLAN 802.11b: -50.0 μ s

WLAN 802.11g: -50.0 μ s

Bluetooth: -15.0 μ s

Radar 200ns: -50.0 ns

Radar 5us: -500 ns

DME: -5 μ s

Demo Box Int

Trigger: -10 μ s

Trigger Source

Range: Continuous | Internal A | Internal B | External

Default: Continuous

GSM 900: Internal A

GSM 1800: Internal A

GPRS: Internal A

WLAN 802.11a: Internal A

WLAN 802.11b: Internal A

WLAN 802.11g: Internal A

Bluetooth: Internal A

Radar 200 ns: Internal A

Radar 5 us: Internal A

DME: Internal A

Demo Box Int

Trigger: Internal A

Units

Range: dBm | dB | dBr | dBmV | dB V | dBW | % | %r | W | V | Vr

Default: dBm

Universal Sensor Mode

Range: Fast CW | True RMS

Default: Stored in sensor

Default Values and Presets

Upper Limit Value

Range: -999.99 to +999.99exp06

Default: +999.99exp06

Upper/Lower Limit Test State

Range: Both | Upper | Lower

Default: Both

Upper/Lower Limit Test State

Range: Both | Upper | Lower

Default: Both

Appendix D — ML2400A Reference Table

Note: The information in this chapter may be of benefit to users already familiar with existing Anritsu power meters.

In addition to the obvious differences between the ML248xB / ML249xA and the power meters in the ML2400A series, there are also many similarities in the basic grouping of commands and operation concepts. Users familiar with the ML2400A series power meters should quickly be able to adapt to the improvements made on the ML248xB / ML249xA. To make this process easier, this chapter provides a table summarizing some of the key differences in terms of the location of the commands. This information will not be of benefit to users who are new to Anritsu power meters.

The table below is split into three columns, the left column detailing the procedure or command in question, and the center and right side columns giving the required hard and soft key combinations for both the ML248xB / ML249xA and ML2400A.

Table D-1. Command Reference Table

Command / Procedure	ML2400A series	ML248xB / ML249xA
Averaging	Sensor / [Averaging]	Channel / [Averaging]
Triggering	Trigger	Channel / [Trigger]
Markers (cursor)	System / [Control]	Channel / [Markers]
Preset	System / [Setup] / [More] / [Preset]	Preset
Measurement display	System / [Setup] / [Mode]	Channel / [Setup] / "Meas display"
Change channel	Channel / [Set Up] / [Channel]	Ch1/Ch2
Capture time, delay, and data hold	System / [Profile]	Channel / [Trigger]
Scaling	System / [Control] / [More] / [Scale]	Channel / [More] / [Scaling]
Data hold	System / [Profile] / [Data hold]	Channel / [More] / [Profile Display]

Appendix E — Terminology Glossary

E-1 Terminology Glossary

The table below provides an alphabetical glossary of:

- Acronyms commonly used in this and other related documentation.
- Abbreviations that may be seen on the ML248xB / ML249xA display.

Table E-1. Terms and Meanings

Term	Meaning
Acq	Acquisition
Act	Active
Adv	Advanced
Ampl	Amplitude
Avg	Averaging
Cal	Calibration
CDF	Cumulative Density Function
CDMA	Code-Division Multiple Access
Chan	Channel
Cmb	Combination
Config	Configuration
Cont	Continuous
Corr	Correction
CW	Continuous Wave
Diff	Difference
EDGE	Enhanced Data GSM Environment
EEPROM	Electrically Erasable Programmable Read-Only Memory.
EPROM	Erasable Programmable Read-Only Memory.
Ext	External
Freq	Frequency
Func	Function
GPIB	General Purpose interface Bus
GSM	Global System for Mobile Communications
Id	Identity
IEEE	Institute of Electrical and Electronics Engineers
Ind	Indicator
LAN	Local Area Network
Lim	Limit

Terminology Glossary

Terminology Glossary

Table E-1. Terms and Meanings

Term	Meaning
Lvl	Level
Max	Maximum
Meas	Measurement
Min	Minimum
Mkr	Marker
Num	Number
PDF	Probability Density Function
Pk	Peak
Pos	Position
POST	Power On Self-Test
Pwr	Power
Ref	Reference
Rel	Relative
Res	Resolution
RRS	Random repetitive sampling
RS232C	Recommended standard-232C
Sngl	Single
Spec	Specification
TTL	Transistor-Transistor Logic
USB	Universal Serial Bus,
Vltg	Voltage
WCDMA	Wideband CDMA
WLAN	Wireless Local-Area Network

Appendix F — Technical Support

Whilst every effort has been made to ensure the quality and reliability of this product, there may be times when operation difficulties are experienced and technical support is required.

Technical support can be obtained from your local sales and service center by visiting <http://www.anritsu.com/contact.asp>

Be prepared to supply the following information:

- Product model
- Power meter serial number
- Sensor model
- Sensor serial number
- Firmware version
- DSP and FPGA sub version
- Description of the problem
- List of error messages
- Description of steps required to reproduce the problem
- Actions already taken to correct the problem

Every effort will be made to ensure that you are contacted within one working day.

Appendix G — Uncertainty Information

Power measurement uncertainty has many component parts that affect uncertainty when measuring power with Anritsu power sensors.

- Instrument Accuracy - the accuracy of the meter used to read the power sensor.
- Sensor Linearity and Temperature Linearity - Sensor linearity and temperature linearity describe the relative power level response over the dynamic range of the sensor.
- Temperature linearity should be considered when operating the sensor at other than room temperature.
- Noise, Zero Set and Drift - These are factors within the test system that impact measurement accuracy at the bottom of a power sensor dynamic range.
- Mismatch Uncertainty - Mismatch uncertainty is typically the largest component of measurement uncertainty. The error is caused by differing impedances between the power sensor and the device to which the power sensor is connected. Mismatch uncertainty can be calculated as follows:

$$\% \text{ Mismatch Uncertainty} = 100 \{ | 1 + \tilde{A}_1 \tilde{A}_2 |^2 - 1 \}$$

$$\text{dB Mismatch Uncertainty} = 20 \log | 1 + \tilde{A}_1 \tilde{A}_2 |$$

where

\tilde{A}_1 and \tilde{A}_2 are the two differing impedances that are connected together.

- Sensor Calibration Factor Uncertainty - Sensor Calibration Factor Uncertainty is defined as the accuracy of the sensor calibration at a standard calibration condition.
- Anritsu follows the industry standard condition of calibration at reference power = 0 dBm (1 mW) and ambient temperature = 25_C.
- Reference Power Uncertainty - Reference power uncertainty specifies the maximum possible output drift of the power meter 50 MHz, 0.0 dBm power reference between calibration intervals.

G-1 Uncertainty Examples

There are several ways in which uncertainties can be calculated. The classic way is to take each parameter from the data sheet and RSS (square Root of the Sum of the Squares) the values together. It is valid to RSS the values together because the measured bands are not physically correlated.

Although this method is commonly used, most measurands have a probability associated with them and rather than implying an absolute value that can never be exceeded, an alternative method of expressing uncertainties using probability distributions has been used by standards labs worldwide. Further details on this methodology can be found in documents such as the UKAS M3003 Guide to expression of Uncertainty. In this methodology each measured band is assigned a probability distribution. The limit for each measured band is then divided by the correction factor for this distribution and an RSS calculation is then performed for all uncertainties to give a probability that the uncertainty lies within the calculated limits. This figure is then expanded, assuming a normal distribution to give the

Uncertainty Examples

Uncertainty Information

uncertainty at a factor of k=2 which is a probability of 95.8% that the uncertainty will lie within the calculated limits.

The table below shows the difference between the two methods. In this table the mismatch uncertainty is assumed to be rectangular. This is only because this has been calculated using the published limits for the VSWR of the sensor. If an actual measurement had been used of the VSWR then the mismatch should be treated as a U-shaped distribution and the value divided by $\sqrt{2}$ for the purposes of the calculation.

This example has been for a MA2472D sensor, CW mode, 16 GHz, 12.0dBm, source VSWR 1.5:1

Table G-1. Uncertainty

Measurement	Probability Distribution	Dividing Factor	MA2472D RRS	MA2472D Probability
Instrumentation Accuracy	Rectangular	$\sqrt{3}$	0.50%	0.29%
Sensor Linearity	Rectangular	$\sqrt{3}$	1.80%	1.04%
Noise	Normal @2 σ	2	0.00%	0.00%
Zero Set and drift	Rectangular	$\sqrt{3}$	0.00%	0.00%
Mismatch Uncertainty	Rectangular	$\sqrt{3}$	3.67%	2.12%
Sensor Cal factor Uncertainty	Normal @2 σ	2	0.83%	0.42%
Reference Power Uncertainty	Rectangular	$\sqrt{3}$	1.2%	0.69%
Reference to Sensor Mismatch Uncertainty	Rectangular	$\sqrt{3}$	0.23%	0.13%
Temperature linearity	Rectangular	$\sqrt{3}$	1.00%	0.58%
RSS Total			4.31%	
RSS k=1				2.58%
RSS expanded k=2	95.8% probability			5.16%

Appendix H — Frequently Asked Questions

Can I use my existing sensors with my new power meter?

Yes, all of the sensors used with the ML2400A series power meter can be used with the ML248xB / ML249xA. The MA2499A sensor adapter is not supported and as a result none of the sensors designed for the ML4803A power meter can be used.

Can I use sensors made by other manufacturers?

Yes, the MA2497A sensor adapter can be used for Agilent sensors on both the ML248xB and the ML249xA.

Why are some of my settings greyed out?

There are two main reasons why the settings in a dialog or the soft key commands may be unavailable. These include:

- Settings or commands that are not applicable to the current configuration. In this case, changing the associated settings may enable the greyed out areas.
- Settings or commands that are not applicable until the main setting in the group has been enabled.

Are the channels and the sensor inputs the same thing?

No, the two terms should not be confused. The sensor inputs are the physical connector(s) on the front panel to which the sensors are attached. The ML2488B and ML2496A have two sensor inputs, labelled A and B, and the ML2487B and ML2495A have one. The channels, of which all power meter models have two, can be configured for either of the available inputs, can be set up to measure a signal from either a CW or pulsed/modulated source, and can display the measurement results in either a profile (graphical) or readout form.

How often do I need to calibrate the sensor?

Anritsu recommend that the sensor be calibrated at the beginning of each measurement session. To do this, connect the sensor to the "Calibrator" port on the front of the unit and use the commands that display after pressing the **Cal/Zero** hard key. Refer to the explanations in chapter 5 of this manual for details.

Is the ML248xB / ML249xA a replacement for the earlier ML2400A series power meter?

No, the ML248xB / ML249xA is designed to expand the Anritsu Power Meter range by adding a Peak Power Meter to the product line-up. The ML2400A series power meters will continue to be manufactured and supported.

Can I capture screen images?

Screen images can be captured as bitmaps using the "ScreenCapture.exe" program on the CD. Refer to the explanation in chapter 5 of this manual.

Frequently Asked Questions

Appendix I — Connector Care and Handling

Follow the precautions listed below when handling or connecting cables. Complying with these precautions will guarantee longer component life and less equipment down time due to connector or device failure.

I-1 Pin Depth Mating Connectors

Destructive pin depth of mating connectors is the major cause of failure in the field. When an RF component is mated with a connector having a destructive pin depth, damage will usually occur to the RF component connector. A destructive pin depth is one that is too long in respect to the reference plane of the connector (see figure below).

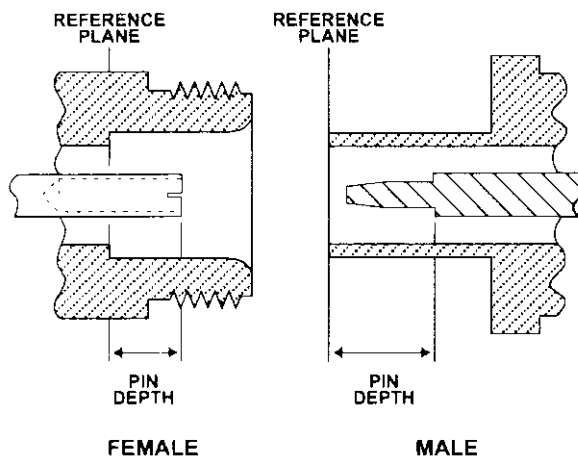

Figure I-1. N Connector Pin Depth Definition

The center pin of a precision RF component connector has a precision tolerance. The mating connectors of various RF components may not be precision types. Consequently, the center pins of these devices may not have the proper pin depth. The pin depth of EUT connectors should be measured to assure compatibility before attempting to mate them with Power Sensor connectors. An Anritsu Pin Depth Gauge or equivalent can be used for this purpose.

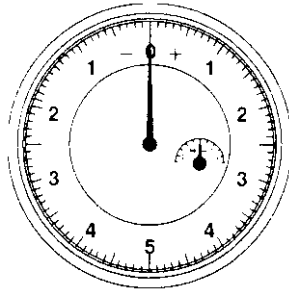

Figure I-2. Pin Depth Gauge

If the measured connector is out of tolerance in the "+" region, the center pin is too long (see Allowable EUT connector pin depth table below). Mating under this condition will likely damage the precision RF component connector. If the test device connector measures out of tolerance in the "-" region, the center pin is too short. This should not cause damage, but it will result in a poor connection and a consequent degradation in performance.

EUT Connector Type	Anritsu Gauging Set Model	Pin Depth (inches)	Pin Depth Gauge Reading
N - Male	01-163	207 -0.000	207 +0.000
N - Female		+0.030	-0.030
WSMA - Male	01-162	-0.000	Same as pin depth
WSMA - Female		-0.010	
3.5 mm - Female			

I-2 Torquing Connectors

Over torquing connectors is destructive; it may damage the connector center pin. Finger-tight is usually sufficient for Type N connectors. Always use a connector torque wrench (8 inch-pounds) when tightening WSMA, K or V type connectors. Never use pliers to tighten connectors.

I-3 Mechanical Shock

Precision connectors are designed to withstand years of normal bench handling. However, do not drop or otherwise treat them roughly. Mechanical shock will significantly reduce their service life.

I-4 Cleaning Connectors

The precise geometry that makes possible the RF component's high performance can easily be disturbed by dirt and other contamination adhering to the connector interfaces. When not in use, keep the connectors covered.

To clean the connector interfaces, use a clean cotton swab that has been dampened with isopropyl alcohol.

Note

Most cotton swabs are too large to fit in the smaller connector types. In these cases, it is necessary to peel off most of the cotton and then twist the remaining cotton tight. Be sure that the remaining cotton does not get stuck in the connector. Cotton swabs of the appropriate size can be purchased through a medical laboratory-type supply center.

The following are some important tips on cleaning connectors:

- Use only isopropyl alcohol as a cleaning solvent
- Do not use excessive amounts of alcohol as prolonged drying of the connector may be required
- Never put lateral pressure on the center pin of the connector
- If installed, do not disturb the Teflon washer on the center conductor pin
- Verify that no cotton or other foreign material remains in the connector after cleaning it
- If available, use compressed air to remove foreign particles and to dry the connector
- After cleaning, verify that the center pin has not been bent or damaged.

Index

Numerics	
802.11a/b/g	15-1
A	
accessories	2-3
active gate	5-26
auto triggering	5-17
averaging	5-27
B	
baud rate	8-6
BNC connector	7-2
brightness	8-5
buffering	8-6
C	
cal factor tables	
creating	6-5
editing	6-4
capture screen image	8-3
CDMA setup	13-1
channel information	4-7
channel menu	5-1
channels	
configuration overview	5-3
setting up	5-1
command hierarchies	B-1
connector care	I-1
connector handling	I-1
connectors	
front panel	4-13
rear panel	3-4
cursor	
position	5-56
zooming to	5-56
CW setup	11-1
D	
data entry	4-14
data hold	5-49
default values	C-1
diagnostics	8-11
dialog boxes	4-12
display	4-5
display brightness	8-5
display mode	18-2
display resolution	5-9
dual channel display	5-10
examples	18-1
dual sensor operation	19-1
duty cycle	5-41
E	
EDGE setup	14-1
EEPROM	20-2
entering data	4-14
F	
FAQ	H-1
features	2-2
fences	5-22
firmware, versions	1-1
frame arming	5-20
front panel connectors	4-13
G	
gates	5-22
gates and fences	5-22
gating patterns	5-25
glossary of terms	E-1
GPIB address	8-5, 10-1
GSM setup	12-1
H	
hard keys	4-4
I	
identity dialog	8-11
increment steps	8-10
inspection	3-1
instrument display	4-5
instrument features	2-2
instrument models	2-1
instrument overview	2-1
instrument settings	
recalling	8-2
saving	8-1
IP address	
LAN	8-7
static	8-7
K	
key click	8-10
keypad	4-3
L	
LAN IP address	8-7
limit fail indicator	5-46

M to S

limits
 alarm on failure 5-47
 complex 5-42
 editing 5-45
 recalling 5-44
 repeating 5-46
 simple 5-41

M

manual
 about 1-1
 associated documentation 1-1
 associated documents 1-1
 conventions 1-2
 markers
 active marker 5-32
 delta marker 5-33
 delta marker calculation 5-34
 overview 5-30
 setting 5-31
 turn all off 5-32
 zooming 5-35
 measurement display style 5-6
 measurement displays 5-2
 measurement mode 5-4
 measurement type 5-5
 measurement units 5-8
 memory types 20-1
 ML2400A reference D-1
 model types 2-1
 MX249001A, PowerMax software A-1

N

non-volatile RAM 20-1
 numeric keypad 4-3

O

OFDM setup 17-1
 options 2-3
 overview 2-1

P

PAE post processing 5-54
 peaking indicator 5-50
 post processing 5-51
 power on procedure 4-1
 power requirements 3-3
 PowerMax 1-1
 PowerMax software A-1
 preset configurations 9-1

preset values C-1
 profile display
 data hold 5-49
 setting 5-48
 pulse fall time 5-36
 pulse off time 5-38
 pulse repetition interval 5-39
 pulse rise time 5-35
 pulse width 5-37

R

rack mounting
 single unit 3-2
 radar setup 16-1
 random repetitive sampling 5-16
 rear panel
 configuration 8-7
 connectors 3-4
 remote operation 10-1
 repeat gates 5-26
 resetting system 9-1
 resolution 5-9
 RS232 baud rate 8-6

S

sampling rate 5-20
 screen 4-5
 screen image capture 8-3
 screen title 8-2
 secure mode 20-1
 security 8-11
 sensor
 calibration 7-2
 calibration factor 6-2
 power offset 6-3
 set up 6-1
 zero and cal 7-1
 zeroing 7-1
 sensor information 4-6
 sensor input 5-7
 sensor offset tables
 creating 6-7
 editing 6-7
 sensors 2-3
 holding at range 6-9
 settling percentage 5-9
 shipment 3-2
 shipped items 3-1
 soft keys 4-10

software 1-1
 PowerMax 1-1, A-1
 upgrade 8-12
 versions 1-1
 status bar 4-9
 storage 3-2
 support F-1
 system reset 9-1
 system upgrade 8-12

T

technical support F-1
 terminology glossary E-1
 trace measurement scale 5-47

trigger
 arming 5-19
 auto 5-17
 capture time 5-15
 delay 5-17
 indicator 5-21
 level 5-18
 mechanism 5-13
 type 5-14

U

uncertainty information G-1
 units of measurement 5-8
 upgrade 8-12

W

WLAN setup 15-1

Z

zero dBm calibration 7-2

Anritsu



Anritsu utilizes recycled paper and environmentally conscious inks and toner.

Anritsu Company
490 Jarvis Drive
Morgan Hill, CA 95037-2809
USA
<http://www.anritsu.com>