

Agilent ENA-L RF Network Analyzers

E5061A, 300 kHz to 1.5 GHz

E5062A, 300 kHz to 3 GHz

Data Sheet

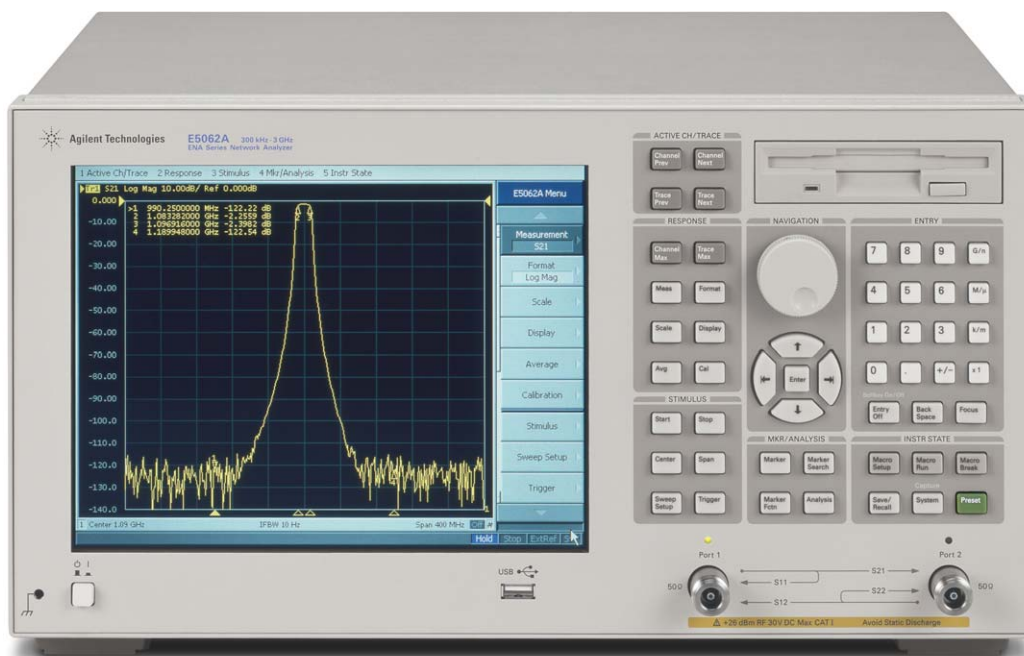

Agilent Technologies

Definitions

All specifications apply over a $23\text{ }^{\circ}\text{C} \pm 5\text{ }^{\circ}\text{C}$ range (unless otherwise stated) and 90 minutes after the instrument has been turned on.

Specification (spec.):

Warranted performance. Specifications include guardbands to account for the expected statistical performance distribution, measurement uncertainties, and changes in performance due to environmental conditions.

Supplemental information is intended to provide information that is helpful for using the instrument but that is not guaranteed by the product warranty.

Typical (typ.):

Describes performance that will be met by a minimum of 80% of all products. It is not guaranteed by the product warranty.

Supplemental performance data (SPD):

Represents the value of a parameter that is most likely to occur; the expected mean or average. It is not guaranteed by the product warranty.

General characteristics:

A general, descriptive term that does not imply a level of performance.

Corrected system performance

The specifications in this section apply for measurements made with the Agilent E5061A/E5062A network analyzer with the following conditions:

- No averaging applied to data
- Environmental temperature of 23 °C ±5 °C, with less than 1 °C deviation from the calibration temperature
- Response and isolation calibration not omitted

Table 1-1 System dynamic range^{1 2}

Description	Specification	SPD
System dynamic range		
300 kHz to 1 MHz, IF bandwidth = 3 kHz	90 dB	
1 MHz to 3 GHz, IF bandwidth = 3 kHz	95 dB	
300 kHz to 1 MHz, IF bandwidth = 10 Hz	115 dB	
1 MHz to 3 GHz, IF bandwidth = 10 Hz	120 dB	130 dB

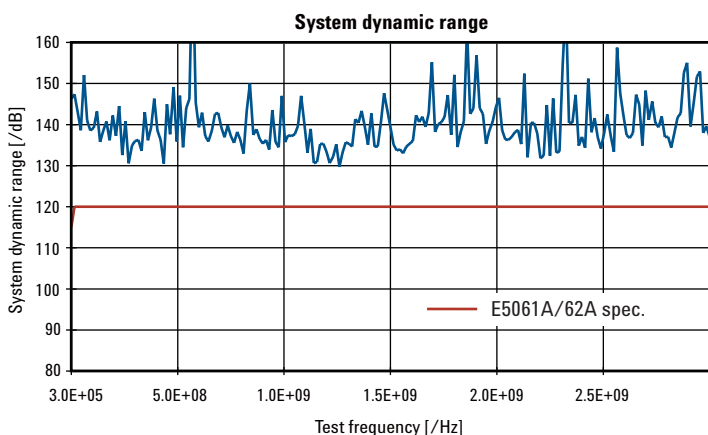

System dynamic range; specification and measurement example

1. The test port dynamic range is calculated as the difference between the test port rms noise floor and the source maximum output power. The effective dynamic range must take measurement uncertainty and interfering signals into account.
2. Applicable to the units with serial prefix MY442 and above .

Table 1-2 Corrected system performance with Type-N 50 Ω connectors, 85032F calibration kit, full 2-port calibration

Network analyzer: E5061A/E5062A, calibration kit: 85032F (Type-N, 50 Ω), calibration: full 2-port

IF bandwidth = 10 Hz, No averaging applied to data, environmental temperature = 23 °C ±5 °C with < 1 °C deviation from calibration temperature, isolation calibration not omitted

Description	Specification (dB)	
	300 kHz to 1.5 GHz	1.5 to 3 GHz
Directivity	49	46
Source match	41	40
Load match	49	46
Reflection tracking	±0.011	±0.021
Transmission tracking	±0.015	±0.018

Transmission uncertainty (specification)

Magnitude

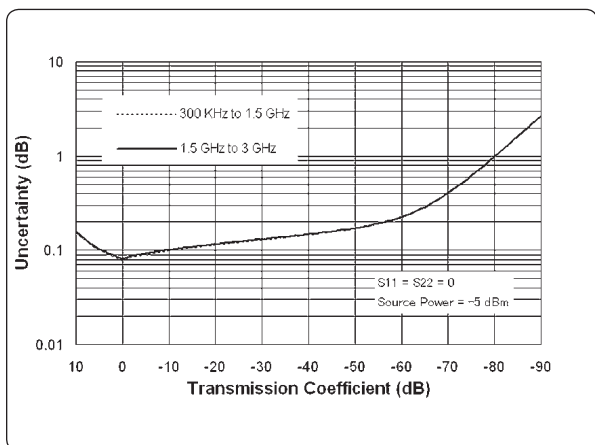

Phase

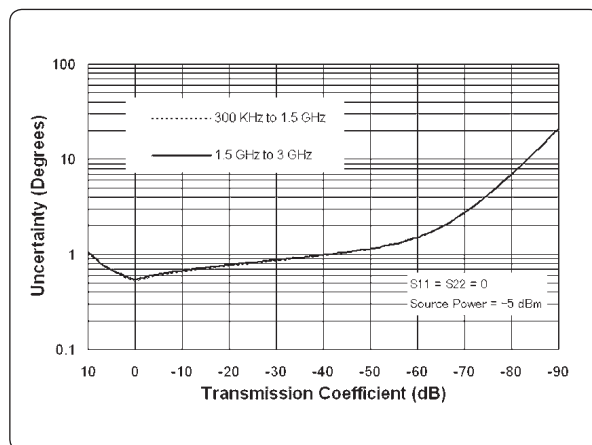

Reflection uncertainty (specification)

Magnitude

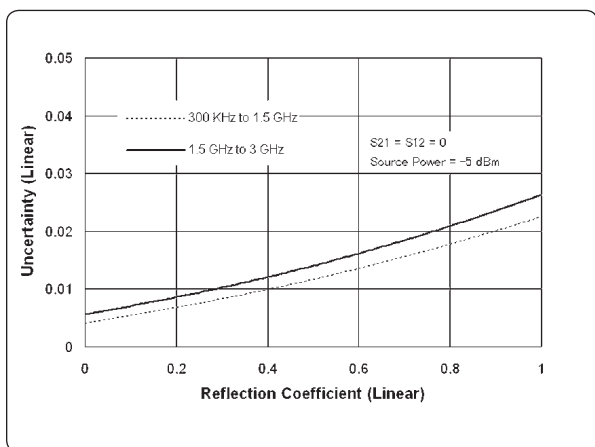

Phase

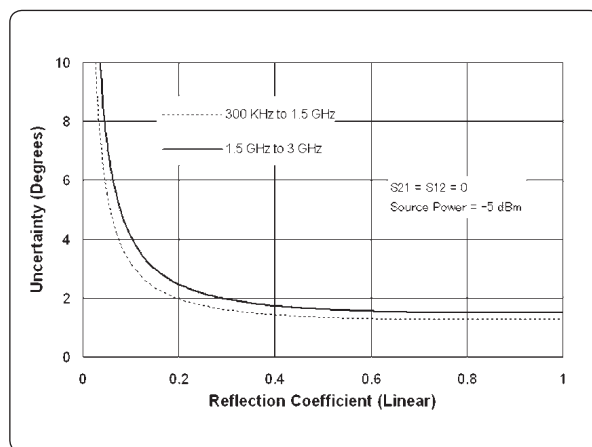

Table 1-3 Corrected system performance with Type-N 50 Ω connectors, 85032F calibration kit, enhanced response calibration

Network analyzer: E5061A/E5062A, calibration kit: 85032F (Type-N, 50 Ω) calibration: enhanced response

IF bandwidth = 10 Hz, no averaging applied to data, environmental temperature = 23 °C ±5 °C with < 1 °C deviation from calibration temperature, isolation calibration not omitted

Description	Specification (dB)	
	300 kHz to 1.5 GHz	1.5 to 3 GHz
Directivity	49	46
Source match	41	40
Load match	15	15
Reflection tracking	±0.011	±0.021
Transmission tracking	±0.015	±0.018

Transmission uncertainty (specification)

Magnitude

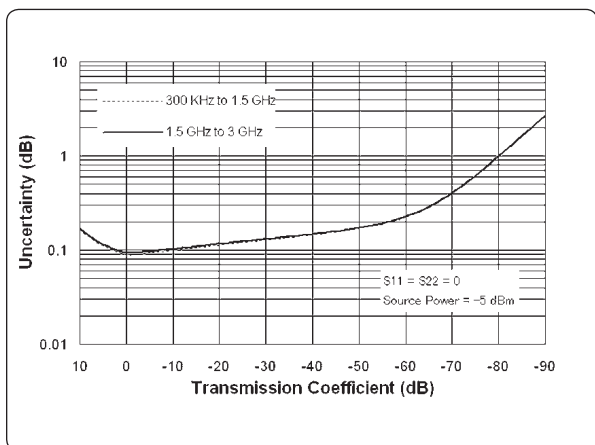

Phase

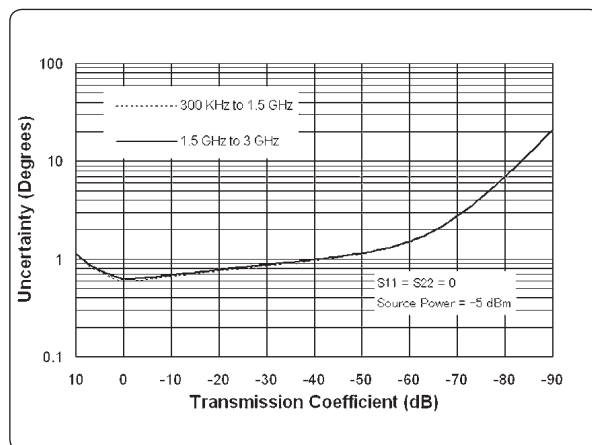

Reflection uncertainty (specification)

Magnitude

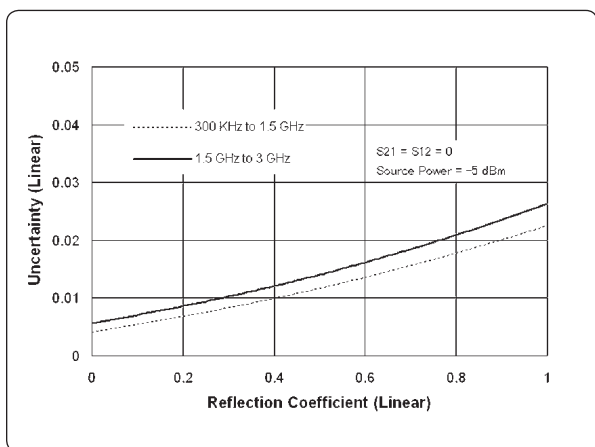

Phase

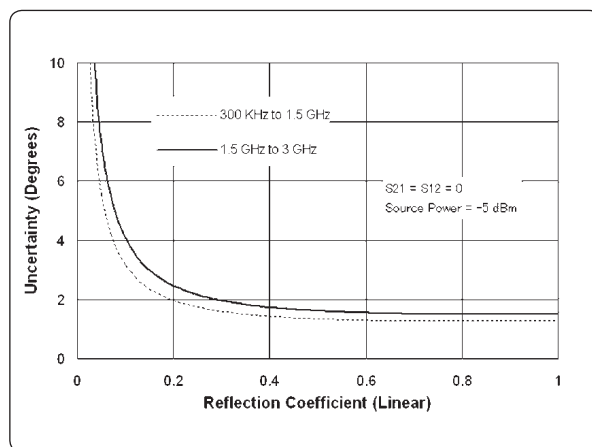

**Table 1-4 Corrected system performance with Type-N 75 Ω connectors
85036E calibration kit, full 2-port calibration**

Network analyzer: E5061A/E5062A, calibration kit: 85036E (Type-N, 75 Ω), calibration: full 2-port

IF bandwidth = 10 Hz, no averaging applied to data, environmental temperature = 23 °C ±5 °C with < 1 °C deviation from calibration temperature, isolation calibration not omitted

Description	Specification (dB)	
	300 kHz to 1.5 GHz	1.5 to 3 GHz
Directivity	48	44
Source match	41	35
Load match	48	44
Reflection tracking	±0.010	±0.019
Transmission tracking	±0.015	±0.029

Transmission uncertainty (specification)

Magnitude

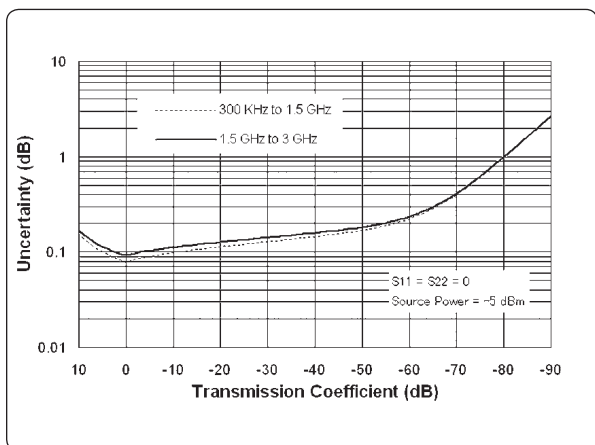

Phase

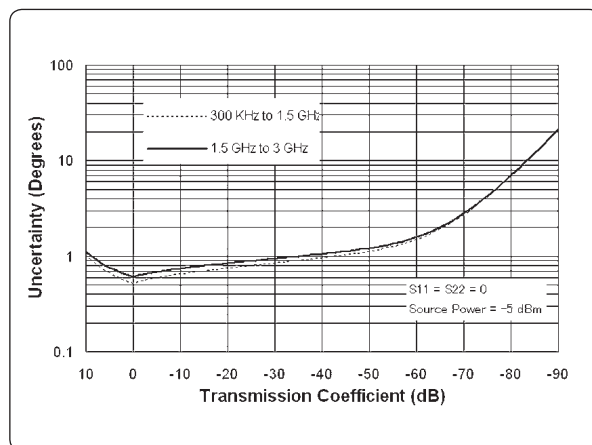

Reflection uncertainty (specification)

Magnitude

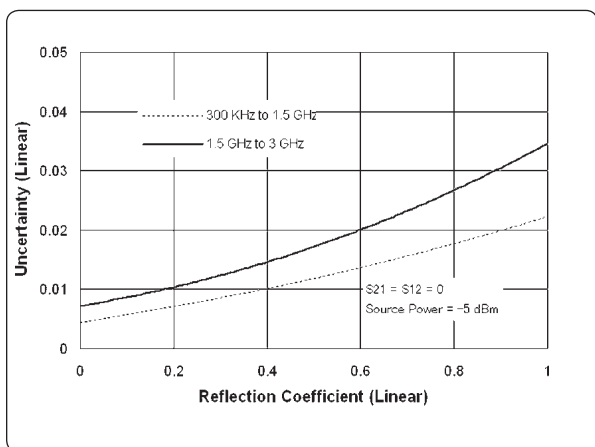

Phase

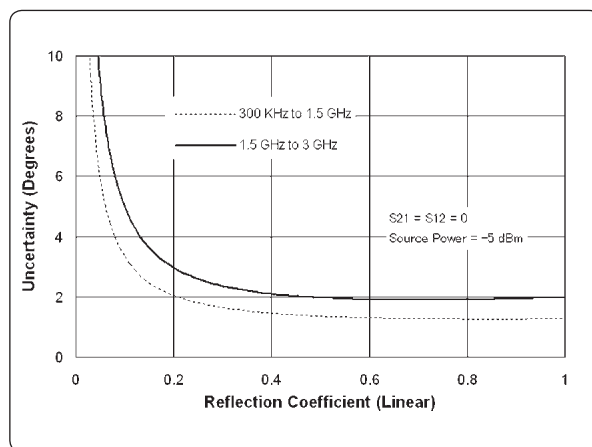

**Table 1-5 Corrected system performance with Type-N 75 Ω connectors
85036E calibration kit, enhanced response calibration**

Network analyzer: E5061A/E5062A, calibration kit 85036E (Type-N, 75 Ω), calibration: enhanced response

IF bandwidth = 10 Hz, no averaging applied to data, environmental temperature = 23 °C ±5 °C with < 1 °C deviation from calibration temperature, isolation calibration not omitted

Description	Specification (dB)	
	300 kHz to 1.5 GHz	1.5 to 3 GHz
Directivity	48	44
Source match	41	35
Load match	15	15
Reflection tracking	±0.010	±0.019
Transmission tracking	±0.015	±0.029

Transmission uncertainty (specification)

Magnitude

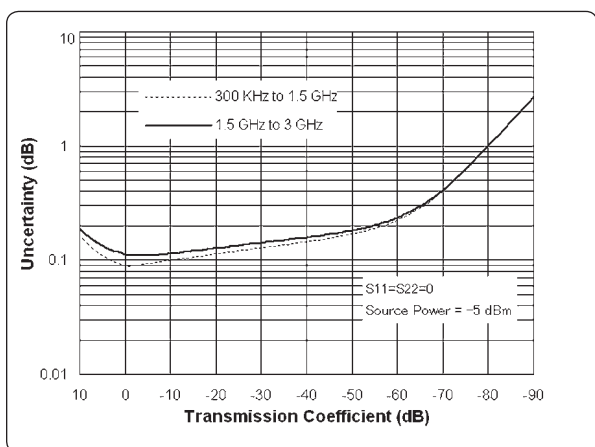

Phase

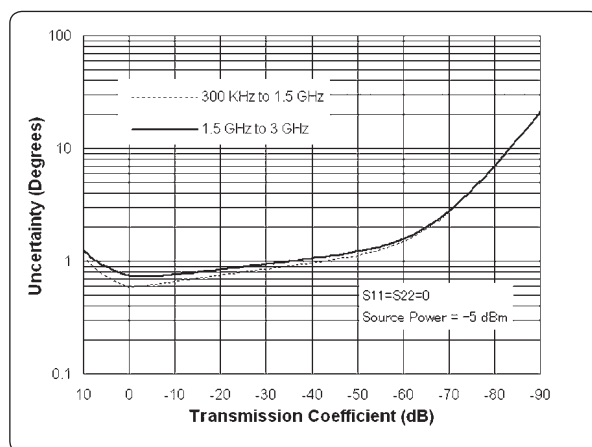

Reflection uncertainty (specification)

Magnitude

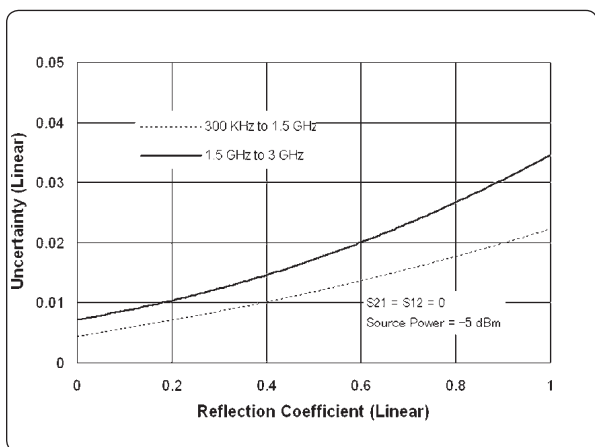

Phase

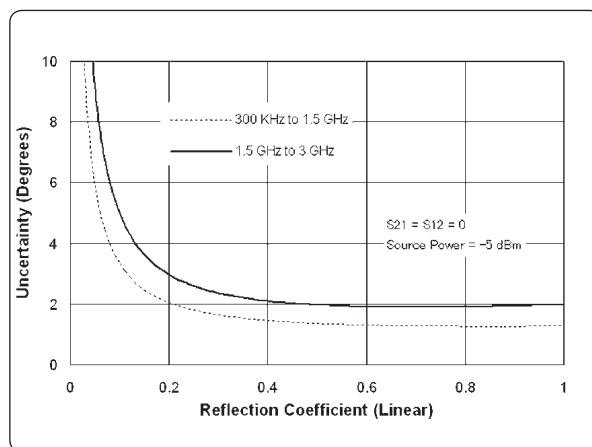

Uncorrected system performance

Table 1-6 **Uncorrected system performance**
(correction: off, 23 °C ±5 °C)

Description	Specification
	300 kHz to 3 GHz
Directivity	25 dB
Source match	25 dB
Load match	15 dB
Transmission tracking	±1.0 dB
Reflection tracking	±1.0 dB

Test port output (source)

Table 1-7 **Test port output frequency**

Description	Specification	Typical
Range		
E5061A	300 kHz to 1.5 GHz	
E5062A	300 kHz to 3 GHz	
Resolution	1 Hz	
Source stability		
E5061A/E5062A		±5 ppm (5 °C to 40 °C)
CW accuracy		
E5061A/E5062A	±5 ppm, 23 °C ±5 °C	

Test port output (source)

Table 1-8 Test port output power

Description	Specification	Typical
Level accuracy (at 23 °C ±5 °C)¹		
300 kHz to 3 GHz	±0.8 dB (at 0 dBm, 50 MHz absolute) ±1.0 dB (at 0 dBm, relative to 50 MHz reference)	
Level linearity (at 23°C ±5°C)		
300 kHz to 3 GHz	±0.75 dB (at -5 to 10 dBm)	
Range (standard)		
300 kHz to 3 GHz	-5 to 10 dBm	
Range (extended power)		
300 kHz to 3 GHz		-45 to 10 dBm (non-harmonics spurious may limit power range)
Sweep range (without extended power range)		
300 kHz to 3 GHz	-5 to 10 dBm	
Level resolution	0.05 dB	

Test port output (source)

Table 1-9 Test port output signal purity

Description	Specification	Typical
Harmonics (2nd or 3rd)		
10 MHz to 2 GHz		< -25 dBc (at 5 dBm)
Non-harmonic spurious		
10 MHz to 3 GHz		< -30 dBc (at 0 dBm)

1. Level accuracy for 75Ω analyzers is not a specification for frequencies >2 GHz; it is a typical characteristic.

Test port input

Table 1-10 Test port input levels

Description	Specification	Typical
Maximum test port input level		
300 kHz to 3 GHz	+10 dBm	
Damage level		
300 kHz to 3 GHz		+20 dBm, ±30 VDC
Crosstalk¹		
300 kHz to 3 GHz	-110 dB	

Table 1-11 Test port input (trace noise²)

Description	Specification	Typical
Trace noise magnitude		
300 kHz to 1 MHz (source power level = +10 dBm)	8 mdB rms (23 °C ±5 °C)	
1 MHz to 3 GHz (source power level = +10 dBm)	5 mdB rms (23 °C ±5 °C)	
Trace noise phase		
300 kHz to 1 MHz (source power level = +10 dBm)	0.05° rms (23 °C ±5 °C)	
1 MHz to 3 GHz (source power level = +10 dBm)	0.03° rms (23 °C ±5 °C)	

Table 1-12 Test port input (stability³)

Description	Specification	Typical
Stability magnitude		
3 MHz to 3 GHz		0.01 dB/°C (at 23 °C ±5 °C)
Stability phase		
3 MHz to 3 GHz		0.1°/°C (at 23 °C ±5 °C)

1. Response calibration not omitted.
2. Trace noise is defined as a ratio measurement of a through, at IF bandwidth = 3 kHz.
3. Stability is defined as a ratio measurement at the test port.

Table 1-13 Test port input (dynamic accuracy)

Accuracy of the test port input power reading is relative to -10 dBm reference input power level.

Specification

Typical

Magnitude

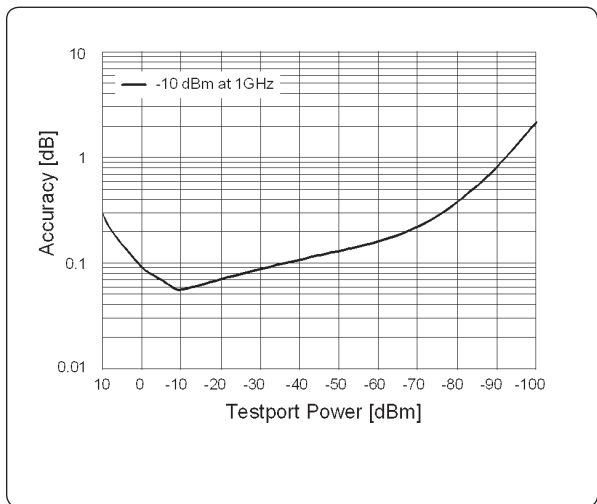

Phase

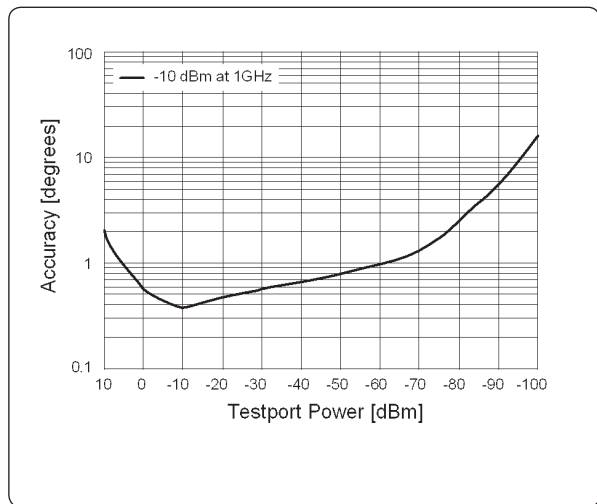
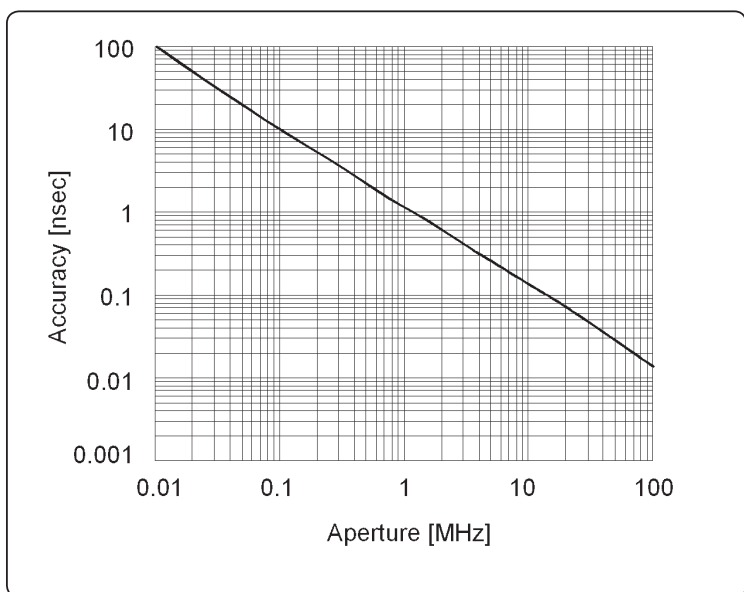

Table 1-14 Test port input (group delay¹)

Description	Specification	Supplemental information
Aperture (selectable)	(frequency span)/(number of points -1)	
Maximum aperture	25% of frequency span	
Minimum delay		Limited to measuring no more than 180° of phase change within the minimum aperture.
Accuracy		See graph below

The following graph shows group delay accuracy with Type-N full 2-port calibration and a 10 Hz IF bandwidth. Insertion loss is assumed to be < 2 dB.

Group delay (typical)



In general, the following formula can be used to determine the accuracy, in seconds, of specific group delay measurement:
 $\pm \text{phase accuracy (deg)} / [360 \times \text{aperture (Hz)}]$

1. Group delay is computed by measuring the phase change within a specified step (determined by the frequency span and the number of points per sweep).

General information

Table 1-15 System bandwidths

Description	General characteristics
IF bandwidth settings	
Range	10 Hz to 30 kHz Nominal settings are: 10, 30, 100, 300, 1 k, 3 k, 10 k, 30 k

Table 1-16 Front panel information

Description	General characteristics
RF connectors	
Type	Type-N, female; 50 Ω or 75 Ω
Display	
Size	10.4 in TFT color LCD
Resolution	VGA (640 x 480) ¹

1. Valid pixels are 99.99% and more. Below 0.01% of fixed points of black, blue, green or red are not regarded as failure.

Table 1-17 Rear panel information

Description	General characteristics
External trigger connector	
Type	BNC, female
Input level	LOW threshold voltage: 0.5 V HIGH threshold voltage: 2.1 V Input level range: 0 to +5 V
Pulse width	$\geq 2 \mu\text{sec}$
Polarity	Negative (downward) only
External reference signal input connector	
Type	BNC, female
Input frequency	10 MHz ± 10 ppm
Input level	0 dBm ± 3 dB
Internal reference signal output connector	
Type	BNC, female
Output frequency	10 MHz ± 10 ppm
Signal type	Sine wave
Output level	0 dBm ± 3 dB into 50 Ω
Output impedance	50 Ω
VGA video output	15-pin mini D-Sub; female; drives VGA compatible monitors
GPIB	24-pin D-Sub (type D-24), female; compatible with IEEE-488
Parallel port	36-pin D-Sub (type 1284-C), female; provides connection to printers, or multiport test set
USB port	Universal serial bus jack, type A configuration (4 contacts inline, contact 1 on left); female; provides connection to printer, ECal module, USB/GPIB interface
Contact 1	Vcc: 4.75 to 5.25 VDC, 500 mA, maximum
Contact 2	-Data
Contact 3	+Data
Contact 4	Ground
LAN	10/100 BaseT Ethernet, 8-pin configuration; auto selects between the two data rates
Handler I/O port	36-pin Centronics, female; provides connection to handler system
Line power¹	
Frequency	47 Hz to 63 Hz
Voltage	90 to 132 VAC, or 198 to 264 VAC (automatically switched)
VA max	350 VA max.

1. A third-wire ground is required.

Table 1-18 EMC and safety





Description	General characteristics
EMC	
	European Council Directive 89/336/EEC EN / IEC 61326-1:1997+A1:1998 CISPR 11:1997+A1:1999 / EN 55011:1998+A1:1999 Group 1, Class A IEC 61000-4-2:1995 / EN 61000-4-2:1995+A1:1998 4 kV CD / 4 kV AD IEC 61000-4-3:1995 / EN 61000-4-3:1996+A1:1998 3 V/m, 80-1000 MHz, 80% AM IEC 61000-4-4:1995 / EN 61000-4-4:1995 1 kV power / 0.5 kV Signal IEC 61000-4-5:1995 / EN 61000-4-5:1995 0.5 kV Normal / 1 kV Common IEC 61000-4-6:1996 / EN 61000-4-6:1996 3 V, 0.15-80 MHz, 80% AM IEC 61000-4-11:1994 / EN 61000-4-11:1994 100% 1cycle
ICES/NMB-001	Canada ICES001:1998 Note: The performance of EUT will be within the specification over the RF immunity tests according to EN 61000-4-3 or EN 61000-4-6 except under the coincidence of measurement frequency and interference frequency.
 N10149	AS/NZS 2064.1/2 Group 1, Class A
Safety	
	European Council Directive 73/23/EEC IEC 61010-1:1990+A1+A2 / EN 61010-1:1993+A2 INSTALLATION CATEGORY II, POLLUTION DEGREE 2 INDOOR USE IEC60825-1:1994 CLASS 1 LED PRODUCT
 LR95111C	CAN/CSA C22.2 No. 1010.1-92

Table 1-19 Analyzer environment and dimensions

Description	General characteristics
Operating environment	
Temperature	+5 °C to +40 °C
Error-corrected temperature range	23 °C ±5 °C with < 1 °C deviation from calibration temperature
Humidity	20% to 80% at wet bulb temperature < +29 °C (non-condensing)
Altitude	0 to 2,000 m (0 to 6,561 feet)
Vibration	0.5 G maximum, 5 Hz to 500 Hz
Non-operating storage environment	
Temperature	-10 °C to +60 °C
Humidity	20% to 90% at wet bulb temperature < 40 °C (non-condensing)
Altitude	0 to 4,572 m (0 to 15,000 feet)
Vibration	0.5 G maximum, 5 Hz to 500 Hz
Dimensions	See figure 1-1 through figure 1-3.
Weight	13.5 kg

Figure 1-2. Dimensions (front view, in millimeters)

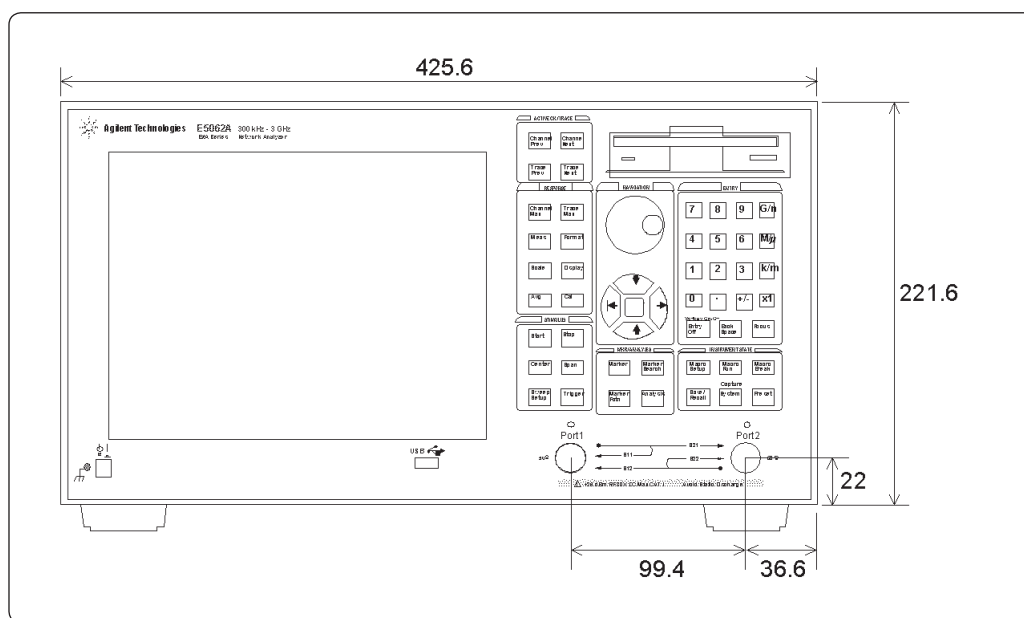

Figure 1-3. Dimensions (rear view, in millimeters)

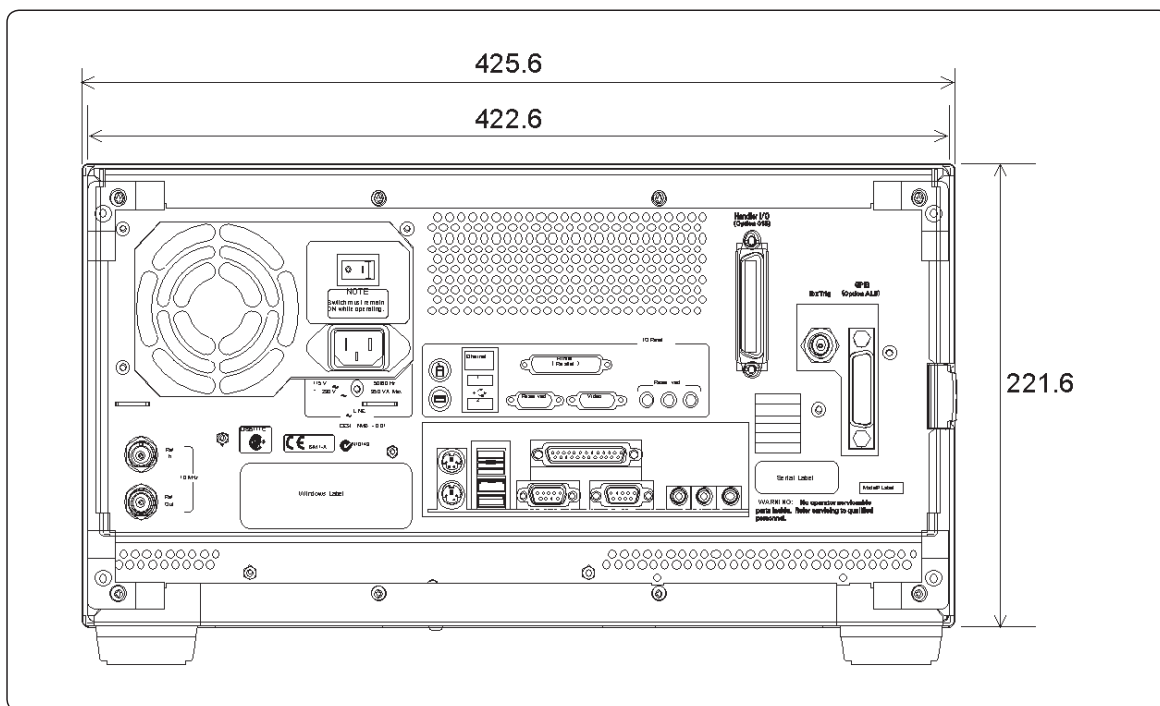
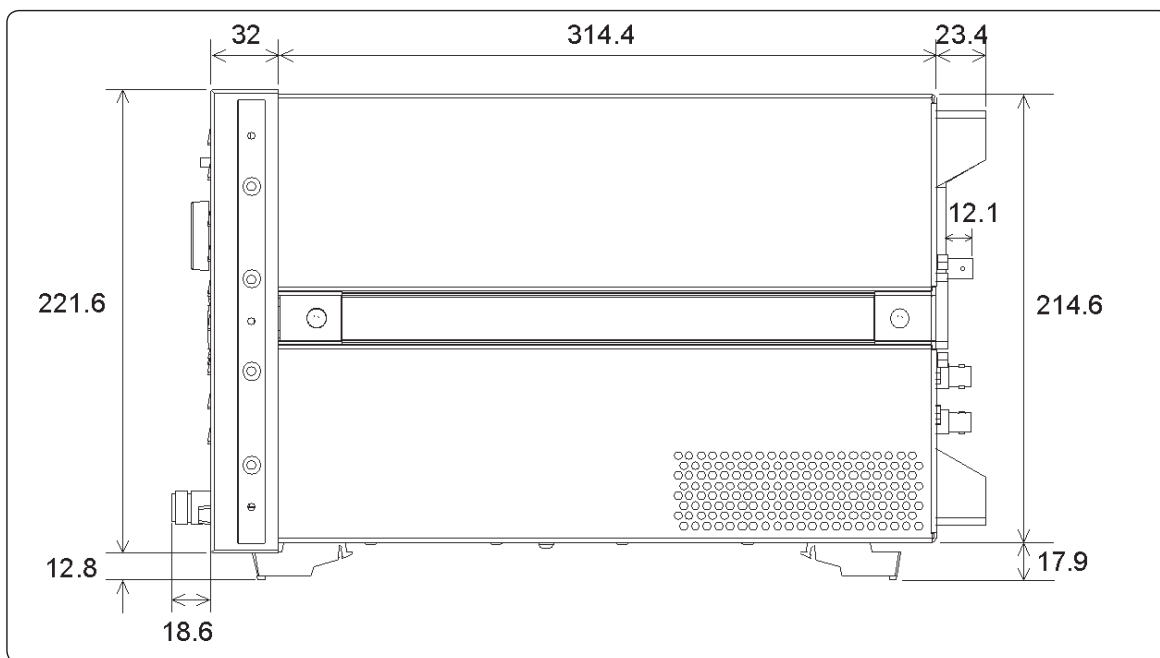

Figure 1-4. Dimensions (side view, in millimeters)



Measurement throughput summary

Table 1-20 Typical cycle time for measurement completion¹ (ms) (Display update: off)

	Number of points			
	51	201	401	1601
Start 1 GHz, stop 1.2 GHz, 30 kHz IF bandwidth				
Uncorrected	8	19	33	117
2-port cal	14	35	63	230
Start 300 kHz, stop 1.5 GHz, 30 kHz IF bandwidth				
Uncorrected	15	25	39	123
2-port cal	27	48	75	243
Start 300 kHz, stop 3 GHz, 30 kHz IF bandwidth				
Uncorrected	17	28	41	125
2-port cal	31	53	80	247

Table 1-21 Typical cycle time for measurement completion¹ (ms) (Display update: on)

	Number of points			
	51	201	401	1601
Start 1 GHz, stop 1.2 GHz, 30 kHz IF bandwidth				
Uncorrected	59	68	83	172
2-port cal	85	103	131	304
Start 300 kHz, stop 1.5 GHz, 30 kHz IF bandwidth				
Uncorrected	64	74	89	178
2-port cal	95	116	144	317
Start 300 kHz, stop 3 GHz, 30 kHz IF bandwidth				
Uncorrected	66	78	91	180
2-port cal	98	121	148	322

1. Typical performance.

Table 1-22 Data transfer time¹ (ms)

Number of points	51	201	401	1601
SCPI over GPIB²				
REAL 64	6	14	25	89
ASCII	51	193	383	1522
SCPI over 100 Mbps LAN (telnet)²				
REAL 64	3	3	4	6
ASCII	92	354	510	2040
SCPI over 100 Mbps LAN (SICL-LAN)²				
REAL 64	7	7	8	12
ASCII	9	21	34	127
COM (program executed in the analyzer)²				
Variant type	2	2	2	2

1. Typical performance.

2. Measured using a VEE 6.01 program running on a 500 MHz Pentium[®] III Dell Optiplex, Transferred complex S₁₁ data, using :CALC:DATA?SDATA.

Measurement capabilities

Number of measurement channels	Up to 4 independent measurement channels. A measurement channel is coupled to stimulus response settings including frequency, IF bandwidth, power level, and number of points.
Number of display windows	Each measurement channel has a display window. Up to 4 display windows (channels) can be displayed.
Number of traces	4 data traces and 4 memory traces per channel
Measurement choices	Option E5061A/E5062A-150/175: S_{11} , S_{21} Option E5061A/E5062A-250/275: S_{11} , S_{21} , S_{12} , S_{22}
Measurement parameter conversion	Available to convert S-parameters into reflection impedance, transmission impedance, reflection admittance, transmission admittance, and 1/S.
Data formats	Log magnitude, linear magnitude, phase, expanded phase, positive phase, group delay, SWR, real, imaginary, Smith chart, polar.
Data markers	10 independent markers per trace. Reference marker available for delta marker operation. Smith chart format includes 5 marker formats: linear magnitude/phase, log magnitude/phase, real/imaginary, $R + jX$, and $G + jB$. Polar chart format includes 3 marker formats: linear magnitude/phase, log magnitude/phase, and real/imaginary.
Marker functions	
Marker search	Max value, min value, multi-peak, multi-target, peak, peak left, peak right, target, target left, target right, and width parameters with user-defined bandwidth values.
Marker-to functions	Set start, stop, center to active marker stimulus value; set reference to active marker response value; set electrical delay to group delay at active marker.
Search range	User definable.
Tracking	Performs marker search continuously or on demand.
Fault location functions (Option E5061A/E5062A-100)	
Transformation to distance and time domain	Selectable transformation type from bandpass, lowpass impulse, lowpass step. Selectable window from maximum, normal and minimum.
LXI compliance	Class C (only applies to units that are shipped with firmware revision A.03.00 or later).

Source control

Measured number of points per sweep	User definable from 2 to 1601.
Sweep type	Linear sweep, segment sweep, log sweep and power sweep.
Segment sweep	Define independent sweep segments. Set number of points, test port power levels, IF bandwidth, delay time, sweep time and sweep mode independently for each segment.
Sweep trigger	Set to continuous, hold, or single, sweep with internal, external, manual, or bus trigger.
Power	Set source power from -5 dBm (-45 dBm for option E5061A/E5062A-1E1/250/275) to 10 dBm. The power slope function compensates source power level error.

Trace functions

Display data	Display current measurement data, memory data, or current measurement and memory data simultaneously.
Trace math	Vector addition, subtraction, multiplication or division of measured complex values and memory data.
Title	Add custom title to each channel window. Titles are printed on hardcopies of displayed measurements.
Autoscale	Automatically selects scale resolution and reference value to vertically center the trace.
Electrical delay	Offset measured phase or group delay by a defined amount of electrical delay, in seconds.
Phase offset	Offset measured phase or group delay by a defined amount in degrees.
Statistics	Calculates and displays mean, standard deviation and peak-to-peak deviation of the data trace.

Data accuracy enhancement

Measurement calibration	Measurement calibration significantly reduces measurement uncertainty due to errors caused by system directivity, source and load match, tracking and crosstalk. Full 2-port calibration removes all the systematic errors for the related test ports to obtain the most accurate measurements.
Calibration types available	
Response	Simultaneous magnitude and phase correction of frequency response errors for either reflection or transmission measurements.
Response and isolation	Compensates for frequency response and crosstalk errors of transmission measurements.
Enhanced response	Compensates for frequency response and source match errors
One-port calibration	Compensates for directivity, frequency response and source match errors.
Full 2-port calibration (Option E5061A/E5062A-250/275)	Compensates for directivity, source match, reflection tracking, load match, transmission tracking and crosstalk. Crosstalk calibration can be omitted.
Interpolated error correction	With any type of accuracy enhancement applied, interpolated mode recalculates the error coefficients when the test frequencies are changed. The number of points can be increased or decreased and the start/stop frequencies can be changed.
Velocity factor	Enter the velocity factor to calculate the equivalent physical length.
Reference port extension	Redefine the measurement plane from the plane where the calibration was done.

Storage

Internal hard disk drive	Store and recall instrument states, calibration data, and trace data on 10 GB, minimum, internal hard drive. Trace data can be saved in CSV (comma separated value) format. All files are MS-DOS [®] -compatible. Instrument states include all control settings, limit lines, segment sweep tables, and memory trace data.
File sharing	Internal hard disk drive (D:) can be accessed from an external Windows [®] PC through LAN.
Disk drive	Instrument states, calibration data, and trace data can be stored on an internal 3.5 inch 1.4 MB floppy disk in MS-DOS [®] -compatible format.
Screen hardcopy	Printouts of instrument data are directly produced on a printer. The analyzer provides USB and parallel interfaces.

System capabilities

Familiar graphical user interface	The ENA-L analyzer employs a graphical user interface based on Windows [®] operating system. There are three ways to operate the instrument manually: you can use a hardkey interface, touch screen interface (option E5061A/E5062A-016) or a mouse interface.
Limit lines	Define the test limit lines that appear on the display for pass/fail testing. Defined limits may be any combination of horizontal/sloping lines and discrete data points.

Automation

	GPIB	Internal
SCPI	X	X
COM		X

Methods

Internal analyzer execution	Applications can be developed in a built-in VBA® (Visual Basic for Applications) language. Applications can be executed from within the analyzer via COM (component object model) or using SCPI.
Controlling via GPIB	The GPIB interface operates to IEEE 488.2 and SCPI protocols. The analyzer can be controlled by a GPIB external controller. The analyzer can control external devices using a USB/GPIB interface.

LAN

Standard conformity	10 BaseT or 100 BaseTX (automatically switched), Ethertwist, RJ45 connector
Protocol	TCP/IP
Function	Telnet, SICL-LAN

Web Resources

For additional literature and product information about the Agilent ENA-L visit:

www.agilent.com/find/ena

www.agilent.com



Agilent Email Updates

www.agilent.com/find/emailupdates
Get the latest information on the products and applications you select.



Agilent Direct

www.agilent.com/find/agilentdirect
Quickly choose and use your test equipment solutions with confidence.



www.lxistandard.org

LXI is the LAN-based successor to GPIB, providing faster, more efficient connectivity. Agilent is a founding member of the LXI consortium.

Remove all doubt

Our repair and calibration services will get your equipment back to you, performing like new, when promised. You will get full value out of your Agilent equipment throughout its lifetime. Your equipment will be serviced by Agilent-trained technicians using the latest factory calibration procedures, automated repair diagnostics and genuine parts. You will always have the utmost confidence in your measurements. For information regarding self maintenance of this product, please contact your Agilent office.

Agilent offers a wide range of additional expert test and measurement services for your equipment, including initial start-up assistance, onsite education and training, as well as design, system integration, and project management.

For more information on repair and calibration services, go to:

www.agilent.com/find/removealldoubt

For more information on Agilent Technologies' products, applications or services, please contact your local Agilent office. The complete list is available at:

www.agilent.com/find/contactus

Americas

Canada	(877) 894-4414
Latin America	305 269 7500
United States	(800) 829-4444

Asia Pacific

Australia	1 800 629 485
China	800 810 0189
Hong Kong	800 938 693
India	1 800 112 929
Japan	0120 (421) 345
Korea	080 769 0800
Malaysia	1 800 888 848
Singapore	1 800 375 8100
Taiwan	0800 047 866
Thailand	1 800 226 008

Europe & Middle East

Austria	01 36027 71571
Belgium	32 (0) 2 404 93 40
Denmark	45 70 13 15 15
Finland	358 (0) 10 855 2100
France	0825 010 700*
	*0.125 €/minute
Germany	07031 464 6333
Ireland	1890 924 204
Israel	972-3-9288-504/544
Italy	39 02 92 60 8484
Netherlands	31 (0) 20 547 2111
Spain	34 (91) 631 3300
Sweden	0200-88 22 55
Switzerland	0800 80 53 53
United Kingdom	44 (0) 118 9276201

Other European Countries:

www.agilent.com/find/contactus

Revised: July 2, 2009

Product specifications and descriptions in this document subject to change without notice.

© Agilent Technologies, Inc. 2009
Printed in USA, September 18, 2009
5989-0018EN

Microsoft®, Windows® and Visual Basic® are U.S. registered trademarks of Microsoft Corporation.

Pentium® is a US registered trademarks of Intel Corporation.

